

The author(s) shown below used Federal funds provided by the U.S. Department of Justice and prepared the following final report:

Document Title: Police Integrity Lost: A Study of Law Enforcement Officers Arrested

Author(s): Philip Matthew Stinson, Sr., J.D, Ph.D., John Liederbach, Ph.D., Steven P. Lab, Ph.D., Steven L. Brewer, Jr., Ph.D.

Document No.: 249850

Date Received: April 2016

Award Number: 2011-IJ-CX-0024

This report has not been published by the U.S. Department of Justice. To provide better customer service, NCJRS has made this federally funded grant report available electronically.

Opinions or points of view expressed are those of the author(s) and do not necessarily reflect the official position or policies of the U.S. Department of Justice.

**POLICE INTEGRITY LOST: A STUDY OF
LAW ENFORCEMENT OFFICERS ARRESTED**

Final Technical Report

Award Number: 2011-IJ-CX-0024
National Institute of Justice
Office of Justice Program
U.S. Department of Justice

Principal Investigator:

Philip Matthew Stinson, Sr., J.D, Ph.D.
Telephone: 419-372-0373
E-Mail: stinspm@bgsu.edu

Co-Investigators:

John Liederbach, Ph.D.
Telephone: 419-372-1053
E-Mail: jlieder@bgsu.edu

Steven P. Lab, Ph.D.
Telephone: 419-372-2326
E-Mail: slab@bgsu.edu

Consultant:

Steven L. Brewer, Jr., Ph.D.
Telephone: 724-983-2954
E-Mail: slb64@psu.edu

Criminal Justice Program
Department of Human Services
College of Health & Human Services
Bowling Green State University
Bowling Green, OH 43403-0148

<http://www.bgsu.edu/policeintegritylost>

January 2016

This project was supported by Award No. 2011-IJ-CX-0024, awarded by the National Institute of Justice, Office of Justice Programs, U.S. Department of Justice. The opinions, findings, and conclusions or recommendations expressed in this report are those of the authors and do not necessarily reflect those of the Department of Justice.

ABSTRACT

There are no comprehensive statistics available on problems with police integrity, and no government entity collects data on all criminal arrests of law enforcement officers in the United States. Police crimes are those crimes committed by sworn law enforcement officers with the general powers of arrest. These crimes can occur while the officer is either on- or off-duty and include offenses committed by officers employed by state and local law enforcement agencies. This study provides a wealth of data on a phenomena that relates directly to police integrity— data that previously did not exist in any useable format.

The first goal of the study is to determine the nature and extent of police crime in the United States. The objective for this goal is to determine the incidence and prevalence of officers arrested. A second goal is to determine what factors influence how an agency responds to arrests of its officers. Objectives for this goal are to determine whether certain factors influence agency response and employment outcomes: (a) severity of crimes for which officers are arrested; (b) level of urbanization for each employing agency; (c) geographic location for each employing agency; (d) length of service and age of arrested officers; and, (e) criminal case outcomes. A final goal is to foster police integrity by exploring whether officer arrests correlate with other forms of police misconduct. Objectives for this goal are to determine whether arrested officers were also named as a civil defendant in any 42 U.S.C. §1983 federal court actions during their careers, and to inform practitioners and policymakers of strategies that will better identify problem officers and those at risk for engaging in police crime and its correlates.

The advent of nationwide, objective, and verifiable data on the law-breaking behavior of sworn officers and provides potential benefits to law enforcement agencies that connect the technical expertise of researchers to criminal justice policymakers and practitioners. These data

provide direct guidance in three areas. First, the study provides agencies information on the types of crime that are most frequently perpetrated by police officers. Second, the research provides information on the relationship between police crimes and other types of misbehavior that collectively comprise the problem officer. Third, nationwide data on police crimes and the manner in which arrested officers are organizationally sanctioned provides points of comparison for law enforcement agencies that confront these problems, as well as information on the degree to which law enforcement agencies tend to sanction or ignore certain crimes committed by officers.

This is a quantitative content analysis study of archived records reporting several thousand arrests of police officers during the years 2005-2011. The primary information source is the Google News search engine and its Google Alerts email update service. Chi-Square was used to measure the statistical significance of the association between two variables measured at the nominal level. Cramer's V was utilized to measure the strength of the Chi-Square association. Stepwise binary logistic regression was used to determine which of the predictor variables are statistically significant in multivariate models. Classification tree analysis was utilized to uncover the causal pathways between independent predictors and outcome variables.

The Google News searches resulted in the identification of 6,724 cases in which sworn law enforcement officers were arrested during the years 2005 through 2011. The cases involved the arrests of 5,545 individual sworn officers employed by 2,529 nonfederal state and local law enforcement agencies located in 1,205 counties and independent cities in all 50 states and the District of Columbia. The findings indicate that nonfederal law enforcement officers were arrested nationwide during 2005-2011 at a rate of 0.72 officers arrested per 1,000 officers, and at a rate of 1.7 officers arrested per 100,000 population nationwide.

TABLE OF CONTENTS

EXECUTIVE SUMMARY	14
The Problem of Police Crime	14
The Purpose of the Study	16
Research Design.....	17
Findings.....	21
Conclusion	25
INTRODUCTION	29
Statement of the Problem.....	33
Literature Citations and Review	41
Statement of Rationale for the Research.....	60
METHODS	65
Coding and Content Analysis	65
Statistical Analysis.....	69
Strengths and Limitations	72
RESULTS	76
Part I: Full Police Crime Data Set Models.....	76
Part II: Sex-related Police Crime Data Set Models	104
Part III: Alcohol-related Police Crime Data Set Models	124
Part IV: Drug-related Police Crime Data Set Models.....	139
Part V: Violence-related Police Crime Data Set Models.....	151
Part VI: Profit-motivated Police Crime Data Set Models.....	167
Part VII: Employing Law Enforcement Agencies of Arrested Officers.....	177

CONCLUSION.....	188
Discussion of Findings.....	189
Implications for Policy and Practice.....	199
Implications for Further Research	207
REFERENCES	210
DISSEMINATION OF RESEARCH FINDINGS.....	232
Publications.....	232
Presentations	235
TABLES	229
Table 1 – Arrested Officers and Agencies.....	238
Table 2 – Most Serious Offense Charged.....	239
Table 3 – Victim Characteristics.....	240
Table 4 – Police Crime Arrest Cases: Bivariate Associations of Conviction.....	241
Table 5 – Police Crime Arrest Cases: Logistic Regression Model Predicting Conviction.....	244
Table 6 – Police Crime Arrest Cases: Bivariate Associations of Job Loss	245
Table 7 – Police Crime Arrest Cases: Logistic Regression Model Predicting Job Loss.....	249
Table 8 – Police Crime: Bivariate Associations of Sex-related Arrest Cases.....	250
Table 9 – Police Crime: Logistic Regression Model Predicting Sex-related Arrest Cases	254
Table 10 – Police Crime: Bivariate Associations of Alcohol-related Arrest Cases.....	255
Table 11 – Police Crime: Logistic Regression Model Predicting Alcohol-related Arrest Cases	259

Table 12 – Police Crime: Bivariate Associations of Drug-Related Arrest Cases	260
Table 13 – Police Crime: Logistic Regression Model Predicting Drug-related Arrest Cases	263
Table 14 – Police Crime: Bivariate Associations of Violence-related Arrest Cases	264
Table 15 – Police Crime: Logistic Regression Model Predicting Violence-related Arrest Cases.....	268
Table 16 – Police Crime: Bivariate Associations of Profit-motivated Arrest Cases	269
Table 17 – Police Crime: Logistic Regression Model Predicting Profit-motivated Arrest Cases.....	273
Table 18 – Civil Rights Litigation as a Correlate of Police Crime: Bivariate Associations of Being Named as a Party Defendant Pursuant to 42 U.S.C. §1983 at Some Point during Law Enforcement Career	274
Table 19 – Logistic Regression Model Predicting Being Named as a Party Defendant in a Section 1983 Action at Some Point during Law Enforcement Career.....	277
Table 20 – Arrested Officers and Agencies in Sex-related Cases	278
Table 21 – Most Serious Offense Charged in Sex-related Cases	279
Table 22 – Victim Characteristics in Sex-related Cases.....	280
Table 23 – Bivariate Associations of Conviction in Sex-related Arrest Cases.....	281
Table 24 – Sex-related Arrest Cases: Logistic Regression Model Predicting Conviction.....	282
Table 25 – Bivariate Associations of Job Loss in Sex-related Arrest Cases.....	283
Table 26 – Sex-related Arrest Cases: Logistic Regression Model Predicting Job Loss.....	284

Table 27 – Bivariate Associations of Child Victims in Sex-related Arrest Cases	285
Table 28 – Sex-related Arrest Cases: Logistic Regression Model Predicting Child Victims	287
Table 29 – Bivariate Associations of Conviction in Police Sexual Violence Arrest Cases	288
Table 30 – Police Sexual Violence Arrest Cases: Logistic Regression Model Predicting Conviction	289
Table 31 – Bivariate Associations of Job Loss in Police Sexual Violence Arrest Cases	290
Table 32 – Police Sexual Violence Arrest Cases: Logistic Regression Model Predicting Job Loss	291
Table 33 – Bivariate Associations of Conviction in Driving-While-Female Arrest Cases	292
Table 34 – Driving-While-Female Arrest Cases: Logistic Regression Model Predicting Conviction	293
Table 35 – Bivariate Associations of Job Loss in Driving-While-Female Arrest Cases	294
Table 36 – Driving-While-Female Arrest Cases: Logistic Regression Model Predicting Job Loss	295
Table 37 – Arrested Officers and Agencies in Alcohol-related Cases	296
Table 38 – Most Serious Offense Charged in Alcohol-related Cases	297
Table 39 – Victim Characteristics in Alcohol-related Cases	298
Table 40 – Police DUI Arrest Cases: Incident Events	299
Table 41 – Police DUI Arrest Cases: Drug-related	300
Table 42 – Bivariate Associations of Conviction in Alcohol-related Arrest Cases	301
Table 43 – Alcohol-related Arrest Cases: Logistic Regression Model Predicting Conviction	302

Table 44 – Bivariate Associations of Job Loss in Alcohol-related Arrest Cases	303
Table 45 – Alcohol-related Arrest Cases: Logistic Regression Model Predicting Job Loss.....	305
Table 46 – Bivariate Associations of Conviction in DUI Arrest Cases	306
Table 47 – DUI Arrest Cases: Logistic Regression Model Predicting Conviction	307
Table 48 – Bivariate Associations of Job Loss in DUI Arrest Cases	308
Table 49 – DUI Arrest Cases: Logistic Regression Model Predicting Job Loss.....	309
Table 50 – Arrested Officers and Agencies in Drug-related Cases	310
Table 51 – Most Serious Offense Charged in Drug-related Cases	311
Table 52 – Specific Drugs.....	312
Table 53 – Victim Characteristics in Drug-related Cases.....	313
Table 54 – Patterns of Drug-related Police Corruption	314
Table 55 – Drug-related Arrest Cases: CART Model Predicting Patterns of Corruption	315
Table 56 – Bivariate Associations of Conviction in Drug-related Arrest Cases.....	316
Table 57 – Drug-related Arrest Cases: Logistic Regression Model Predicting Conviction	317
Table 58 – Bivariate Associations of Job Loss in Drug-related Arrest Cases.....	318
Table 59 – Drug-related Arrest Cases: Logistic Regression Model Predicting Job Loss.....	319
Table 60 – Arrested Officers and Agencies in Violence-related Cases.....	320

Table 61 – Most Serious Offense Charged in Violence-related Cases.....	321
Table 62 – Victim Characteristics in Violence-related Cases.....	322
Table 63 – Bivariate Associations of Conviction in Violence-related Arrest Cases.....	323
Table 64 – Violence related Arrest Cases: Logistic Regression Model Predicting Conviction.....	326
Table 65 – Bivariate Associations of Job Loss in Violence-related Arrest Cases.....	327
Table 66 – Violence-related Arrest Cases: Logistic Regression Model Predicting Job Loss.....	330
Table 67 – Bivariate Associations of Conviction in Officer-involved Domestic Violence Arrest Cases.....	331
Table 68 – Officer-involved Domestic Violence Arrest Cases: Logistic Regression Model Predicting Conviction.....	332
Table 69 – Bivariate Associations of Job Loss in Officer-involved Domestic Violence Arrest Cases.....	333
Table 70 – Officer-involved Domestic Violence Arrest Cases: Logistic Regression Model Predicting Job Loss.....	335
Table 71 – Arrested Officers and Agencies in Profit-motivated Cases.....	336
Table 72 – Most Serious Offense Charged in Profit-motivated Cases.....	337
Table 73 – Victim Characteristics in Profit-motivated Cases.....	338
Table 74 – Bivariate Associations of Conviction in Profit-motivated Arrest Cases.....	339
Table 75 – Profit-motivated Arrest Cases: Logistic Regression Model Predicting Conviction.....	341
Table 76 – Bivariate Associations of Job Loss in Profit-motivated Arrest Cases.....	342

Table 77 – Profit-motivated Arrest Cases: Logistic Regression Model Predicting Job Loss.....	344
Table 78 – 200 Largest State and Local Law Enforcement Agencies in Study: Rates of Officers Arrested, 2005-2011 (Sorted by # of Full-Time Sworn Personnel).....	345
Table 79 – Nonmetropolitan State and Local Law Enforcement Agencies in Study: Rates of Officers Arrested, 2005-2011 (Sorted Alphabetically by Agency Name).....	351
Table 80 – Primary State Police Agencies in Study: Rates of Officers Arrested, 2005-2011 (Sorted Alphabetically by Agency Name).....	367
Table 81 – Sheriff’s Offices in Study: Rates of Officers Arrested, 2005-2011 (Sorted Alphabetically by Agency Name).....	369
Table 82 – County Police Departments in Study: Rates of Officers Arrested, 2005-2011 (Sorted Alphabetically by Agency Name).....	382
Table 83 – 500 Largest Municipal Police Departments in Study: Rates of Officers Arrested, 2005-2011 (Sorted Alphabetically by Agency Name).....	384
Table 84 – Special State & Local Law Enforcement Agencies in Study: Rates of Officers Arrested, 2005-2011 (Sorted Alphabetically by Agency Name).....	399
FIGURES.....	403
Figure 1 – Police Crime Arrest Cases: CART Model Predicting Conviction	403
Figure 2 – Police Crime Arrest Cases: CART Model Predicting Job Loss.....	404
Figure 3 – Police Crime: CART Model Predicting Sex-related Arrest Cases	405
Figure 4 – Police Crime: CART Model Predicting Alcohol-related Arrest Cases.....	406

Figure 5 – Police Crime: CART Model Predicting Drug-related Arrest Cases	407
Figure 6 – Police Crime: CART Model Predicting Violence-related Arrest Cases	408
Figure 7 – Police Crime: CART Model Predicting Profit-motivated Arrest Cases	409
Figure 8 – CART Model Predicting Being Named as a Party Defendant in a Section 1983 Action at Some Point during Law Enforcement Career	410
Figure 9 – Sex-related Arrest Cases: CART Model Predicting Conviction	411
Figure 10 – Sex-related Arrest Cases: CART Model Predicting Job Loss	412
Figure 11 – Sex-related Arrest Cases: CART Model Predicting Child Victims	413
Figure 12 – Police Sexual Violence Arrest Cases: CHAID Model Predicting Conviction	414
Figure 13 – Police Sexual Violence Arrest Cases: CART Model Predicting Job Loss	415
Figure 14 – Driving-While-Female Arrest Cases: CHAID Model Predicting Conviction	416
Figure 15 – Driving-While-Female Arrest Cases: CHAID Model Predicting Job Loss	417
Figure 16 – Alcohol-related Arrest Cases: CART Model Predicting Conviction	418
Figure 17 – Alcohol-related Arrest Cases: CART Model Predicting Job Loss	419
Figure 18 – DUI Arrest Cases: CART Model Predicting Conviction	420
Figure 19 – DUI Arrest Cases: CART Model Predicting Job Loss	421

Figure 20 – Drug-related Arrest Cases: CART Model Predicting Conviction	422
Figure 21 – Drug-related Arrest Cases: CART Model Predicting Job Loss	423
Figure 22 – Violence-related Arrest Cases: CART Model Predicting Conviction	424
Figure 23 – Violence-related Arrest Cases: CART Model Predicting Job Loss	425
Figure 24 – Officer-involved Domestic Violence Arrest Cases: CART Model Predicting Conviction	426
Figure 25 – Officer-involved Domestic Violence Arrest Cases: CART Model Predicting Job Loss	427
Figure 26 – Profit-motivated Arrest Cases: CART Model Predicting Conviction	428
Figure 27 – Profit-motivated Arrest Cases: CART Model Predicting Job Loss	429
APPENDIX A: Employing Law Enforcement Agencies: Rates of Officers Arrested Sorted by # of Full-Time Sworn Personnel	430
Appendix A-1 – Nonmetropolitan State and Local Law Enforcement Agencies in Study: Rates of Officers Arrested, 2005-2011 (Sorted by # Full-Time Sworn Personnel)	430
Appendix A-2 – Primary State Police Agencies in Study: Rates of Officers Arrested, 2005-2011 (Sorted by # Full-Time Sworn Personnel)	446
Appendix A-3 – Sheriff’s Offices in Study: Rates of Officers Arrested, 2005-2011 (Sorted by # Full-Time Sworn Personnel)	448
Appendix A-4 – County Police Departments in Study: Rates of Officers Arrested, 2005-2011 (Sorted by # Full-Time Sworn Personnel)	461
Appendix A-5 – 500 Largest Municipal Police Departments in Study: Rates of Officers Arrested, 2005-2011 (Sorted by # Full-Time Sworn Personnel)	463

Appendix A-6 – Special State & Local Law Enforcement Agencies in Study: Rates of Officers Arrested, 2005-2011 (Sorted by # Full-Time Sworn Personnel).....	478
APPENDIX B: Employing Law Enforcement Agencies: Rates of Officers Arrested Sorted by Rate per 1,000 Officers	482
Appendix B-1 – 200 Largest State and Local Law Enforcement Agencies in Study: Rates of Officers Arrested, 2005-2011 (Sorted by Rate per 1,000 Officers).....	482
Appendix B-2 – Nonmetropolitan State and Local Law Enforcement Agencies in Study: Rates of Officers Arrested, 2005-2011 (Sorted by Rate per 1,000 Officers).....	488
Appendix B-3 – Primary State Police Agencies in Study: Rates of Officers Arrested, 2005-2011 (Sorted by Rate per 1,000 Officers).....	504
Appendix B-4 – Sheriff’s Offices in Study: Rates of Officers Arrested, 2005-2011 (Sorted by Rate per 1,000 Officers).....	506
Appendix B-5 – County Police Departments in Study: Rates of Officers Arrested, 2005-2011 (Sorted by Rate per 1,000 Officers).....	519
Appendix B-6 – 500 Largest Municipal Police Departments in Study: Rates of Officers Arrested, 2005-2011 (Sorted by Rate per 1,000 Officers).....	521
Appendix B-7 – Special State & Local Law Enforcement Agencies in Study: Rates of Officers Arrested, 2005-2011 (Sorted by Rate per 1,000 Officers).....	536
APPENDIX C: Employing Law Enforcement Agencies: Rates of Officers Arrested Sorted by Rate per 100,000 Population	540
Appendix C-1 – 200 Largest State and Local Law Enforcement Agencies in Study: Rates of Officers Arrested, 2005-2011 (Sorted by Rate per 100,000 Population).....	540
Appendix C-2 – Nonmetropolitan State and Local Law Enforcement Agencies in Study: Rates of Officers Arrested, 2005-2011 (Sorted by Rate per 100,000 Population).....	546

Appendix C-3 – Primary State Police Agencies in Study: Rates of Officers Arrested, 2005-2011 (Sorted by Rate per 100,000 Population).....	562
Appendix C-4 – Sheriff’s Offices in Study: Rates of Officers Arrested, 2005-2011 (Sorted by Rate per 100,000 Population).....	564
Appendix C-5 – County Police Departments in Study: Rates of Officers Arrested, 2005-2011 (Sorted by Rate per 100,000 Population).....	577
Appendix C-6 – 500 Largest Municipal Police Departments in Study: Rates of Officers Arrested, 2005-2011 (Sorted by Rate per 100,000 Population).....	579
Appendix C-7 – Special State & Local Law Enforcement Agencies in Study: Rates of Officers Arrested, 2005-2011 (Sorted by Rate per 100,000 Population).....	594
APPENDIX D: State and Local Law Enforcement Agencies: Police Crime Arrest Cases	598
APPENDIX E: Entity Relationship Diagram of Stinson’s Police Crime Database	669

EXECUTIVE SUMMARY

This study is a quantitative content analysis of archived news articles and court records reporting on the arrest(s) of law enforcement officers in the United States from 2005-2011. Police crimes are those crimes committed by sworn law enforcement officers given the general powers of arrest at the time the offense was committed. These crimes can occur while the officer is on or off duty and include offenses committed by state, county, municipal, tribal, or special law enforcement agencies. Police crimes damage the occupational integrity of police, the organizational legitimacy of the employing agency, and the overall authority and legitimacy of the law enforcement enterprise. Three distinct but related research questions are addressed in this study. First, what is the incidence and prevalence of police officers arrested across the United States? Second, how do law enforcement agencies discipline officers who are arrested? And, third, to what degree do police crime arrests correlate with other forms of police misconduct?

The Problem of Police Crime

Surprisingly little is known about the crimes committed by law enforcement officers, in part because there are virtually no official nationwide data collected, maintained, disseminated, and/or available for research analyses. Researchers have utilized other methodologies to study police misconduct and crime in the absence of any substantive official data, including surveys, field studies, quasi-experiments, internal agency records, and the investigative reports of various independent commissions delegated to report on this phenomenon within particular jurisdictions. These methodologies have thus far failed to produce systematic, nationwide data on police crime.

The lack of data on police crime is clearly a problem, since the development of strategies to mitigate police crime in the least requires that they be documented and described in some sort of systematic and generalizable manner. From an organizational perspective, more comprehensive data could provide comparisons among agencies on rates of police crime, and subsequently contribute to the development and implementation of policies to deter police crime and lessen damage to police-community relations in their aftermath. From a scholarly perspective, the collection, analysis, and dissemination of more comprehensive police crime data could instigate studies designed to identify significant correlates, explore relationships between police crimes and more general forms of police deviance, and provide information on how police culture and socialization potentially contribute to the problem. Scholars have yet to fully pursue these and other important issues associated with the problem of police crime because we lack any sort of comprehensive data on the types of crime that police commit and how frequently they commit them.

The current study demands a conceptual framework that reflects both the broad range of offenses committed by law enforcement officers and the generalized nature of our research questions. Thus, the findings of the current study are organized within a conceptual framework that incorporates five key types of police crime:

- Sex-related Police Crime
- Alcohol-related Police Crime
- Drug-related Police Crime
- Violence-related Police Crime
- Profit-motivated Police Crime

The study is organized around these five types of police crime. We provide data pertinent to the three broad research questions within each area, as well as additional data that further describes the nature and character of police crime both in general and within each of the five types. The conceptual framework serves to organize data that describes a phenomenon that encompasses a wide range of criminal behavior. The framework also allows for the presentation and discussion of data specifically focused on answering the stated research questions; but also, the wealth of data collected on police crime as part of this project that does not readily fit under one or more of the specific research questions.

The Purpose of the Study

The purpose of the current research project is to promote police integrity by gaining a better understanding of police crime and agency responses to officer arrests. The study provides a wealth of data on a phenomena that relates directly to police integrity—data that law enforcement executives did not previously have access to because they did not exist in any useable format. The first goal of this research is to determine the nature and extent of police crime in the United States. A second goal of this research is to determine what factors influence how a nonfederal law enforcement organization responds to arrests of officers. A third and final goal of the research is to foster police integrity by exploring whether police crime and officer arrests correlate with other forms of police misconduct.

The purpose for the current study evolved from long-standing obstacles associated with the collection of data on police crime. The underlying reasons for the current study reflect the ongoing lack of empirical data on the crimes committed by law enforcement officers—a situation that relates directly to the limitations of previous methodologies used to collect data on the phenomenon. Researchers have resorted to a variety of methodologies to learn more about

the nature and extent of police misconduct, corruption, or crime. Empirical scholarship has usually incorporated one or more of the following: (a) officer surveys, (b) agency records, and (c) sociological field studies. Studies that utilize one or more of these methodologies have clearly contributed to the knowledge base on police crime, but the methodology used in the present study offers clear advantages in terms of both the scope and quality of potential data on police crime.

Research Design

Data for the current study were collected as part of a project designed to locate cases in which sworn law enforcement officers had been arrested for any type of criminal offense(s). Data were derived from published news articles using the Google News search engine and its Google Alerts email update service. Google Alerts searches were conducted using the same 48 search terms developed by Stinson (2009). The Google Alerts email update service sent a message each time one of the automated daily searches identified a news article in the Google News search engine that matched any of the designated search terms. The automated alerts contained a link to the URL for the news articles. The articles were located, examined for relevancy, printed, logged, and then scanned, indexed, and archived in a digital imaging database for subsequent coding and content analyses. The present study focuses on the identification and description of the cases in which police officers were arrested during the years 2005-2011.

Content analyses were conducted in order to code the cases in terms of (a) arrested officer, (b) employing nonfederal law enforcement agency, (c) each of the charged criminal offenses, (d) victim characteristics, (e) organizational adverse employment outcomes, and (f) criminal case dispositions. Each of the charged criminal offenses was coded using the data collection guidelines of the National Incident-Based Reporting System (NIBRS) as the coding

protocol for each criminal offense category (see U.S. Department of Justice, 2000). Fifty-seven criminal offenses are included in the NIBRS, consisting of 46 incident-based criminal offenses in one of 22 crime categories as well as 11 additional arrest-based minor criminal offense categories. In each case every offense charged was recorded on the coding instrument as well as the most serious offense charged in each police crime arrest case. The most serious offense charged was determined using the Uniform Crime Report's (UCR) crime seriousness hierarchy (see U.S. Department of Justice, 2004). An additional eight offenses were added following an earlier pilot study (see Stinson, 2009) because police officers who were arrested often were charged with criminal offenses not included in the NIBRS (e.g., online solicitation of a child, indecent exposure, official misconduct / official oppression / violation of oath, vehicular hit-and-run, perjury / false reports / false statements, criminal deprivation of civil rights).

The primary unit of analysis in this study is criminal arrest case. One of the primary issues in coding was differentiating between arrest cases with multiple victims and officers who were arrested on multiple occasions within the study years 2005-2011. Arrest incidents that involved multiple victims with corresponding criminal charges were assigned an individual case for each respective victim. Additionally, law enforcement officers who were arrested on multiple occasions had an arrest case generated in the project database for each respective arrest.

Cases were also coded on Stinson's (2009) typology of police crime, which posits that most crime committed by police officers is alcohol-related, drug-related, sex-related, violence-related, and/or profit-motivated. The types of police crime are not mutually-exclusive categories. Rather, each type of police crime is coded as a dichotomous variable because crimes committed by officers often involve more than one type of police crime. Additionally, cases were coded for the presence of *police sexual violence* and/or *driving while female* encounters.

Police sexual violence is operationalized as “those situations in which a female citizen experiences a sexually degrading, humiliating, violating, damaging, or threatening act committed by a police officer through the use of force or police authority” (Kraska & Kappeler, 1995, p. 93). Driving while female is operationalized as instances where a police officer stops a female driver under the pretext of an alleged traffic violation and then abuses the power and authority of his position to take advantage of a vulnerable motorist (Walker & Irlbeck, 2002, 2003). In some cases, driving while female encounters escalate into sexual harassment, sexual assault, and in rare instances, forcible rape.

Secondary data were employed from the Census of State and Local Law Enforcement Agencies (CSLLEA) (U.S. Department of Justice, 2008) to ascertain demographic data including the number of full-time sworn personnel and part-time sworn personnel employed by each agency where arrested officers served. County and independent city were used to verify location of arrested officers’ employing law enforcement agencies, as well as for use as a key variable to merge other data sources into the project’s master database and data set. The U.S. Department of Agriculture’s (2003) county-level urban to rural nine-point continuum scale was used to measure rurality. Population data from the U.S. Census Bureau’s decennial census in years 2000 and 2010 were utilized for county, independent city, and state populations.

Analytic procedures were undertaken to ensure reliability of the data. An additional coder was employed to independently code a random sample of five percent of the total number of cases in the study. Intercoder reliability was assessed by calculating the Krippendorff’s alpha coefficient across 195 variables of interest in this study on a random sample ($n = 290$, 4.3%) of the cases in the study ($N = 6,724$) (see Hayes & Krippendorff, 2007). The Krippendorff’s alpha coefficient (Krippendorff’s $\alpha = .9153$) is strong across the variables in this study. The overall

level of simple percentage of agreement between coders across all of the variables in this study (97.7%) also established a degree of reliability well above what is generally considered acceptable in content analysis research.

Chi Square was used to measure the statistical significance of the association between two variables measured at the nominal level. Cramer's *V* measures the strength of that relationship with values that range from zero to 1.0 and allows for an assessment of the importance of the relationship. Stepwise binary logistic regression was used to determine which of the predictor variables are statistically significant in multivariate models. Stepwise logistic regression models are appropriate where the study is purely exploratory and predictive. Classification tree analysis was utilized as a statistical technique to uncover the causal pathways between independent predictors and various outcome variables of interest, including job loss, and conviction. This is an exploratory study because little is known empirically about police crime arrests and the specific factors responsible for conviction and job loss subsequent to the arrest of a sworn law enforcement officers.

Strengths and Limitations

The news search methodology utilizing the Google News search engine and the Google Alerts email update service provided an unparalleled amount of information on police crime arrests at law enforcement agencies across the United States. The Google News search engine algorithm offers some clear advantages over other aggregated news databases and the methodologies employed by previous studies that used news-based content analyses to document cases of sex-related police misconduct. The Google Alerts email update service provides the ability to run persistent automated queries of the Google News search engine and deliver real-time search results.

There are four primary limitations of the data. First, this research study includes every case known to the research team of a nonfederal sworn law enforcement officer who was arrested during the years 2005-2011. Thus, this study is a census of the universe of police crime arrest cases identified through our search methodology. We do not purport to include every single instance of a law enforcement officer being arrested. Second, our research is limited by the content and quality of information provided for each case. The amount of information available on each case varied, and data for several variables of interest were missing for some of the cases. Third, the data are limited to cases that involved an official arrest based on probable cause for one or more crimes. We do not have any data on police officers who engaged in criminal activity if their conduct did not result in an arrest. Fourth, we note that these data are the result of a filtering process that includes the exercise of discretion by media sources in terms of both the types of stories covered and the nature of the content devoted to particular stories. Despite the noted limitations, the use of news articles as the primary data source is a long established method of analyzing deviant/illegal police behavior (see, e.g., Lawrence, 2000; Lersch & Feagin, 1996; Rabe-Hemp & Braithwaite, 2013; Ross, 2000).

Findings

Findings from the study provide three general observations about the nature of police crime overall. First, police crimes are not uncommon. The study identified 6,724 arrest cases from 2005-2011 involving 5,545 sworn law enforcement officers. The arrested sworn law enforcement officers were employed by 2,529 state and local law enforcement agencies located in 1,205 counties and independent cities in all 50 states and the District of Columbia. Sworn law enforcement officers were arrested at a rate of 0.72 per 1,000 officers and 1.7 per 100,000 of the population nationwide. Second, police crime is an occupationally-derived phenomenon. Police

work is conducive to all sorts of criminal behavior, largely because of plentiful opportunities provided by the nature of the work and police-citizen interactions. Third, police crime is complex and multivariate. Police crime can be alcohol-related, drug-related, sex-related, violence-related, or profit-motivated. These five types of police crime are not mutually exclusive, and there are numerous significant predictors of (a) each type of police crime, (b) adverse employment outcomes, and (c) criminal case dispositions. Distinctions between on- and off-duty police crime are often difficult to make. Aside from these general observations, the findings can be summarized in terms of both the full data set and the five types of police crime.

The most common *most serious offense charged* in the cases overall were simple assault (13%), driving under the influence (12.5%), aggravated assault (8.5%), forcible fondling (5.2%), and forcible rape (4.8%). Slightly more than one-half of the cases (54%) ultimately resulted in job loss for arrested officers. The factors that influence whether an arrested officer will be criminally convicted or lose his or her job are numerous and complex, and include both legal factors (e.g., most serious offense charged) and extralegal factors (e.g., age, years of service as a sworn law enforcement officer, relationship of victim to the arrested officer). In terms of case outcomes, the events of job loss and criminal conviction are not isolated. Job loss provides a context for the incidence of criminal conviction and vice versa. The number of cases and officers arrested in terms of the five types of police crime were as follows:

- Sex-related police crime included 1,475 arrest cases of 1,070 sworn officers
- Alcohol-related police crime included 1,405 arrest cases of 1,283 sworn officers
- Drug-related police crime included 739 arrest cases of 665 sworn officers
- Violence-related police crime included 3,328 arrest cases of 2,586 sworn officers
- Profit-motivated police crime included 1,592 cases of 1,396 sworn officers

Sex-related Police Crime

The two most important points in regard to the sex-related crimes include the serious nature of these events and the prevalence of relatively young victims. Serious cases of police sexual violence are not isolated events. The study identified a total of 422 forcible or statutory rapes, 352 cases of forcible fondling, and 94 sodomy arrest cases. Children seem to be particularly vulnerable to law enforcement officers who perpetrate sex crimes. Almost one-half of the known victims were children, and the second-most commonly occurring category in terms of the victim's relationship to the arrested officer was an unrelated child. Arrested officers were criminally convicted on at least one charge in four-fifths (80%) of the sex-related cases in which conviction data were available. The simple odds of job loss are 2.8 times greater if the arrested officer was ultimately convicted of a sex-related crime.

Alcohol-related Police Crime

Job loss in the aftermath of being arrested for an alcohol-related police crime is tied to organizational characteristics of an arrested officer's employing state or local law enforcement agency. Arrested officers employed by law enforcement agencies with 1-99 full-time sworn personnel lost their jobs in less than half (44.6%) of the alcohol-related cases, and officers employed by agencies with 100 or more full-time sworn personnel lost their jobs in less than one-third (29.8%) of the alcohol-related cases.

Sworn law enforcement officers engaging in drunk driving is a major problem and concern. There were 960 cases of police DUI (driving under the influence) arrests. These police DUI arrest cases largely provide examples of officers who have lost their *exemption from law enforcement*. That is to say, state and local sworn law enforcement officers do not typically arrest other sworn law enforcement officers, especially for drunk driving. In many of the police

DUI arrest cases in this study, however, the drunk driving officer did something in terms of the incident events that led to being arrested. For example, many of the police DUI arrest cases involved traffic accidents (51%) often resulting in victim injury (24.1%) or fatalities (4%). Arrested officers are known to have lost their jobs as sworn law enforcement officers in less than one-third (29.8%) of the police DUI arrest cases.

Drug-related Police Crime

Drug-related crime by sworn law enforcement officers tends to spawn all sorts of other kinds of police misconduct and police crime. Personal use of drug does not seem to be the primary problem in drug-related police crime. Drug-related police crime often involves drug trafficking, facilitation of the drug trade, and shakedowns of citizens most often associated with the trade of cocaine and crack. Taken together, cocaine and marijuana account for over one-half of the drug-related police crime arrest cases. Well over one-half of the drug-related police crime arrest cases were also profit-motivated police crime.

Violence-related Police Crime

Policing is often violent. A major problem identified in this study, however, is officer-involved domestic violence. There were 961 cases of officer-involved domestic violence. Approximately one-third of the cases involving a sworn law enforcement arrested for officer-involved domestic violence are known to have resulted in the arrested officer losing his or her job as a result of the arrest. When the victim is currently involved (i.e., current spouse, current boyfriend/girlfriend), the arrested officer is *less likely* to be convicted than when the victim is somebody else in officer-involved domestic violence arrest cases. The simple odds of an officer losing his or her job after being arrested for a crime relating to officer-involved domestic violence are greater when the relationship with the victim is more distant. Serious concerns

regarding compliance with the gun and ammunition prohibitions of the Lautenberg Amendment (1996) to the Federal Gun Control Act of 1968 for persons convicted of qualifying crimes of domestic violence are raised by officer-involved domestic violence arrest cases in this study. There is no exception to the gun prohibition in the federal statute for sworn law enforcement officers who have been convicted of qualifying misdemeanor crimes of domestic violence.

Profit-motivated Police Crime

Most of the profit-motivated crimes occurred at the street-level and involved patrol personnel. These crimes are more like street crimes than white collar crimes. The most common *most serious offense charged* in the profit-motivated police crime arrest cases were unclassified thefts (16%), false pretenses (theft by deception) (12.5%), drug offenses (11.9%), robbery (6.4%) thefts from buildings (5.8%), and extortion or blackmail (5.3%). More than two-thirds of the sworn law enforcement officers arrested for profit-motivated crime lost their jobs (67%) and more than half of the profit-motivated arrest cases resulted in conviction (57.4%). The single largest predictor of job loss in profit-motivated police crime arrest cases is when the profit-motivated crime is also drug-related.

Conclusion

Cases in which sworn law enforcement officers act as criminals—whether dealing drugs, or driving drunk, or sexually molesting a vulnerable citizen—strike a direct blow to the law enforcement enterprise and the essence of what it means to be a law enforcement officer: protect and serve. These cases threaten to undermine public trust in both the authority and legitimacy of state and local law enforcement organizations, and the work of law-abiding sworn officers who go about their job selflessly, efficiently, and professionally every day. Police crime as a topic

worthy of empirical study however is not clearly understood, and would probably best be described as untapped or at the very least not sufficiently explored.

The contrast between the topic's substantive weight and comparatively light coverage within the scholarship is mostly due to an absence of suitable data. The traditional sources of data and methods of study, whether official statistics, self-report surveys, or direct observations, either do not exist in any usable format or are ill-equipped to identify, count, or provide the basis for empirical analyses of instances in which police perpetrate crimes themselves. These cases have thus far escaped large-scale empirical scrutiny, but they *are* intrinsically newsworthy events. Those in the news media need to identify stories that will be of interest to their audience, and cases of police crime typically include storylines that are clearly newsworthy. This project utilized a methodology designed to capitalize on the newsworthy character of police crime, identify these events, and subject them to analyses that have thus far been impossible. Given the previous unavailability of data and the relative absence of empirical studies dedicated to the topic, our work should be considered exploratory. The primary aim was to uncover cases of police crime arrests and to provide the basis for what we hope will become an important contribution to the establishment of a more substantive and useful line of research on the topic.

Implications for Policy and Practice

The findings of the current study have several direct implications for policy and practice in state and local law enforcement agencies. First, employing law enforcement agencies should have written policies to compel mandatory disclosure whenever a sworn officer is arrested for a crime, as well as whenever a court issues an order of protection against a sworn officer. Second, it is imperative that employing law enforcement agencies implement a policy of conducting annual criminal background checks of all current sworn personnel to ascertain if any sworn

officer has been arrested or convicted of any crime. The practice of conducting annual criminal background checks on every sworn law enforcement officer employed will ensure compliance with the gun and ammunition prohibition provisions of the Lautenberg Amendment (1996) to the federal Gun Control Act of 1968. Third, law enforcement agencies should have written policies in place regarding standard agency responses to when a sworn law enforcement officer is arrested, and the policy should address procedures for both situations where a sworn officer employed by that agency is arrested as well as when the agency effectuates the criminal arrest of a sworn law enforcement officer employed by some other law enforcement agency. Finally, many arrested officers experience an unraveling of their lives, and mental health problems can be present in some instances. Early intervention and warning systems should be utilized to track instances of officers being arrested and officers should be referred to employee assistance programs when appropriate.

Acknowledgements

Adam Watkins provided statistics expertise. Hannah Brewer, Michael Buerger, Melissa Burek, Chris Dunn, Judith Leary, and Brooke Mathna provided technical expertise. Dan Lee, Dennis Giever, Paul McCauley, and David Myers offered early encouragement.

The following graduate student research assistants at Bowling Green State University worked on this project: Evin Carmack, Paige Crawford, Jacob Frankhouser, Maria Gardella, Breanne Hitchens, Jessica Kirkpatrick, Krista Long, Matthew Roberts, Dennis Roehrig, Andrew Rudnik, Adam Sierra, Scott Stevenson, Erin Thomson, Natalie Todak, Georgianna Whitely, and Mallorie Wilson.

The following undergraduate student research assistants at Bowling Green State University also worked on this project: Christy Adams, Warifa Azeez, Joelle Bridges, Zachary Calogeras, Vincent Crews, Natalie DiChiro, Charles Eberle, Rachel Fettinger, Madeline Fisher, Joanna Hanson, Breanne Hitchens, Ryan Hunter, Tanya Korte, Theresa Lanese, Mariah Lax, Raven Ory, Tiffany Pleska, Ashley Roberts, Taylor Szalkowski, and Mallorie Wilson.

This project was made possible through the guidance of Chief Information Officer John Ellinger and assistance from numerous Information Technology Services staff at Bowling Green State University, including Adam Arthur, Chad Brandeberry, Kyle Butler, Patrick Enright, Chad Fletcher, Michael Good, Danee Gunka, Lauren Hall, Matthew Haschak, Katrina Horvath, Margo Kammeyer, Clinton LaForest, Bridget Place, Nick Rodgers, Thomas Shuman, Andries Smith, Chris Wammes, and Deb Wells.

INTRODUCTION

Police crimes are those crimes committed by sworn law enforcement officers who are given the general powers of arrest at the time the offense was committed. These crimes can occur while the officer is either on- or off-duty and include offenses committed by officers employed by state, county, municipal, tribal, or special law enforcement agencies. Anecdotes and journalistic investigations indicate that police officers commit various criminal offenses including larceny/theft, drug trafficking, driving while intoxicated, domestic assault, and predatory sex offenses (see, e.g., Kappeler, Sluder, & Alpert, 1998). Further evidence of the crimes committed by police is also contained in the reports of several independent commissions on police misconduct (Knapp Commission, 1972; Mollen Commission, 1994; Pennsylvania Crime Commission, 1974).

The occurrence of police crime should be a concern to police executives, scholars, and the general public. Police crimes damage both the occupational integrity of police and the legitimacy of the employing police agency. But, surprisingly little is known about the crimes committed by law enforcement officers. There are no comprehensive statistics available on the phenomena, and no government entity collects data on criminal arrests of police officers in the United States (Anechiarico & Jacobs, 1996; Barak, 1995; Kane, 2007). There have been very few studies that provide specific data on the nature and prevalence of police crime. Reiss' (1971) classic field research found that officers commonly engaged in on-duty crime, mostly bribe-taking and petty thefts; but, no other large-scale observational studies attempt to determine the prevalence of police crime. Scholars have instead been more likely to broach the topic within the context of more general studies on police corruption or misconduct (Fyfe & Kane, 2006). Some studies use officer surveys to identify police attitudes toward misconduct or to measure

their propensity for criminal behavior under particular scenarios, but these methods are unlikely to produce valid data on actual police crime because police tend to maintain a code of silence or provide socially desirable responses to sensitive questions in regard to their own criminal behavior and/or the criminal behavior of fellow officers (Fishman, 1978; Maguire & Mastrofski, 2000; Maguire & Uchida, 2000).

The lack of statistics and empirical studies on police crime is problematic. First, more comprehensive data could be used to develop policies to deter police crimes and/or mitigate damage to police-community relations in their aftermath. Second, data on the correlates of police crime could provide information on the relationship between police crime and more general forms of police deviance including corruption, discrimination, and other forms of abuse. Third, an expansion of this line of research would provide information on the role of police culture and socialization processes, particularly if these data include both on-duty and off-duty crimes committed over the course of the career. Scholars have yet to fully pursue these questions because we lack any sort of comprehensive statistics on the types of crime committed by police and when and how often they commit them. These exploratory data are necessary to advance the understanding of police crime.

This study is a quantitative content analysis of archived records consisting of news articles and court records reporting the arrests of police officers during the years 2005-2011. The overall purpose of the study is to identify and describe crimes committed by police officers. Three distinct but related research questions guide this research study. First, what is the incidence and prevalence of police officers arrested across the United States? Second, how do law enforcement agencies discipline officers who are arrested? And, third, to what degree do police crime arrests correlate with other forms of police misconduct?

The research questions relate to different aspects relevant to the study of police crime and police integrity more generally. The crimes committed by police officers that are identified and described in this study encompass the broad nature of crime in general and range from the mundane to the most serious, a situation that reflects what Ross (2001) observed as the multidimensional character of police crime. The wide array of criminal offenses committed by police officers also obviously varies in terms of the research questions identified above, including the frequency with which they occur, the frequency and types of discipline imposed, and the degree to which they are associated with other forms of misconduct.

The study of off-duty police misconduct and crime has been complicated by a debate on whether these concepts include acts committed while an officer is technically off-duty. Several policing scholars emphasize the occupational origins of police crime and focus on those acts that occur on-duty under the guise of police authority (Barker & Carter, 1994; Foster, 1966; Stoddard, 1968) and during the course of an officer's normal work activities (Barker, 1978; Ross, 2001). Kappeler et al. (1998) argue that many off-duty crimes should not be considered police crimes because they do not involve some aspect of an officer's occupational position to carry them out. This situation begs questions as to whether off-duty misconduct arises from specialized law enforcement training, skills, and knowledge, or even prevailing occupational norms that may serve to legitimize such behavior.

Fyfe and Kane (2006) make a compelling case for the inclusion of off-duty acts in their study of career-ending police misconduct, an argument that also applies to police crimes. First, the job provides officers unique criminal opportunities that can be taken advantage of either on- or off-duty. Second, police officers are more likely to engage in either on- or off-duty crimes in part because they believe their status as sworn law enforcement officers affords them some

degree of exemption from prosecution (see Reiss, 1971; Stinson, Liederbach, Brewer, & Todak, 2014). Third, most jurisdictions grant full law enforcement powers to off-duty sworn law enforcement officers and permit them to carry service weapons. These factors make it difficult to distinguish between on- and off-duty police behavior because “the knowledge, gun, and badge that comes with being a police officer” often facilitates the off-duty crimes of police officers (Mollen Commission, 1994, p. 30). Other studies have raised concerns about the off-duty gun-involved misconduct of sworn officers (e.g., Commission to Combat Police Corruption, 1998a, 2001a, 2001b, 2010; Fyfe, 1980, 1987, 1988; Kane & White, 2009; Stinson, Liederbach, & Freiburger, 2012).

The current study demands a conceptual framework that reflects both the broad range of offenses committed by law enforcement officers and the generalized nature of our research questions. Thus, the contents of our report are organized within a conceptual framework that incorporates five key types of police crime:

- Sex-related Police Crime
- Alcohol-related Police Crime
- Drug-related Police Crime
- Violence-related Police Crime
- Profit-motivated Police Crime

The remainder of this report is organized around these five key types. We provide data pertinent to the three broad research questions within each area, as well as additional data that further describes the nature and character of police crime both in general and within each of the five types. The conceptual framework serves to organize data that describes a phenomenon that encompasses a wide range of criminal behavior. The framework also allows for the presentation

and discussion of data specifically focused on answering the stated research questions; but also, the wealth of data collected on police crime as part of this project that does not readily fit under one or more of the specific research questions. The latter part of this section introduces the problems associated with these different types of police crime in sequence. Likewise, the Literature Citations and Review section of the report presents overviews of the relevant research literature organized in terms of the five key types of police crime. The Findings portion of this report also incorporates the same conceptual framework and organizing themes. The final section of the report discusses our findings and implications of the study both within and across the key types of police crime.

Statement of the Problem

Scholars have struggled with the task of measuring police integrity because there are virtually no official nationwide data collected, maintained, disseminated, and/or available for research analyses (see, e.g., Anechiarico & Jacobs, 1996; Collins, 1998; Kane, 2007; Klockars, Kutnjak Ivkovic, Harver, & Haberfield, 1997; Kutnjak Ivkovic, 2003; Sherman & Langworthy, 1979; Stinson, Liederbach, & Freiburger, 2010). Complicating the matter is the reality that police officers are largely exempt from law enforcement because there is a reluctance to enforce the law against fellow officers (Klockars, Kutnjak Ivkovic, & Haberfield, 2006; Reiss, 1971). As a result, researchers have resorted to a variety of methodologies in their efforts to learn more about the nature and extent of police crime, corruption, and misconduct. These include surveys (e.g., Barker, 1978; Greene, Piquero, Hickman, & Lawton, 2004), quasi-experiments (e.g., Fyfe & Kane, 2006; Kane & White, 2009, 2013), sociological field studies (e.g., Reiss, 1971; Sherman, 1978), investigation reports of independent commissions (e.g., Christopher Commission, 1991; Knapp Commission, 1972; Mollen Commission, 1994; e.g., Pennsylvania

Crime Commission, 1974), analyses of internal agency records (e.g., Fyfe & Kane, 2006; C. J. Harris, 2009, 2011a, 2011b, 2012; Kane & White, 2009, 2013; Liederbach, Boyd, Taylor, & Kawucha, 2007), and analysis of criminal justice system records (e.g., Collins, 1998; Kutnjak Ivkovic, 2005).

These various methodologies have thus far failed to produce systematic, nationwide data on police crime. These lines of literature do make clear, however, that the phenomenon covers a wide range of criminal behavior that is difficult to generalize. Ross (2001) was among the first to recognize the multidimensional nature of police crime. He developed a taxonomy that in part distinguished the phenomenon in terms of four bipolar distinctions of police criminality. Likewise, Stinson (2009) developed a typology of police crime as a means to both organize data on the wide range of acts committed by police officers and to distinguish various types of police crime. Stinson's typology of police crime is incorporated in the current study. The section below includes a statement of the problem associated with the five types of police crime including: (a) sex-related police crime, (b) alcohol-related police crime, (c) drug-related police crime, (d) violence-related police crime, and (e) profit-motivated police crime.

The Problem of Sex-related Police Crime

Sex-related police crimes encompass a continuum of acts ranging from less serious forms of sexual misconduct to more egregious cases that involve violence, including acts that have been referred to in the research literature as police sexual violence (Rabe-Hemp & Braithwaite, 2013). Police sexual violence has been defined to include acts that are officially recognized and involve violence or the use of police force (Maher, 2003). Police sexual violence occurs when the victim experiences "sexually degrading, humiliating, violating, damaging or threatening acts committed by a police officer through the use of force, fear, intimidation, or police authority"

(Kraska & Kappeler, 1995, p. 93). Less serious forms of sexual misconduct include acts whereby a police officer uses his or her position to “initiate or respond to some sexually-motivated cue for the purpose of sexual gratification” (Maher, 2003, p. 357).

Opportunities for sex-related police crime abound because officers operate in a low visibility environment with very little supervision. The potential victims of sex-related police crime include criminal suspects but also unaccompanied victims of crime (Rabe-Hemp & Braithwaite, 2013). Cases of sex-related police crime often do not involve direct forms of violence, because police may be able to perpetrate these crimes on the basis of threats or other forms of intimidation given their position of authority. Police sexual misconduct and cases of police sexual violence are often referred to as hidden offenses, and studies on police sexual misconduct are usually based on small samples or derived from officer surveys that are threatened by a reluctance to reveal these cases. Rabe-Hemp and Braithwaite (2013) recently identified the need for national level studies on the phenomenon.

The Problem of Alcohol-related Police Crime

A second type of police crime explored in this study is alcohol-related police crime. In August 1998, the (New York City) Commission to Combat Police Corruption released a comprehensive report on the misconduct of New York Police Department (NYPD) officers. The Commission found that a significant number of cases arose out of misconduct that occurred while the officers were off-duty. A large number of the misconduct cases analyzed by the Commission to Combat Police Corruption involved off-duty officers who were intoxicated (Commission to Combat Police Corruption, 2004). The most prevalent charges in these cases were driving under the influence and cases where officers had consumed enough alcohol to be considered unfit for duty. The Commission to Combat Police Corruption report indicates the

magnitude of alcohol-related problems among NYPD officers and suggests that these problems primarily involve both the off-duty consumption of alcohol and cases involving police officers who drive drunk, a phenomenon we refer to as police driving under the influence (DUI). Following the outline of the Commission's findings, this report describes the problem of alcohol-related police crime in two parts: (a) police crimes that involved the consumption of alcohol, and (b) police crimes that specifically involve cases of police DUI.

One problem for scholars interested in the study of alcohol-related police crime stems from the fact that much of it—or at least many of the most visible cases of alcohol-related police crime—seems to occur while police are technically off-duty (Commission to Combat Police Corruption, 2004). Virtually all of the existing data on off-duty police misconduct and crime describes the misbehavior of NYPD police officers. The data are based on either the findings of independent commissions designed to investigate the city's unique cycle of police scandals or published research derived from a data set on career-ending misconduct among NYPD officers from 1975 to 1996 (Fyfe & Kane, 2006; Kane & White, 2009). The existing line of research provides coverage on the off-duty misbehavior of NYPD officers, but the absence of data on the phenomenon as it occurs elsewhere raises legitimate concerns in regard to generalizability. The current study provides much needed data on the alcohol-related police crimes perpetrated by off-duty police officers as these crimes occur nationwide.

Police DUI—or cases in which police are arrested for crimes associated with driving while intoxicated—comprises the second part of our description of alcohol-related police crime. Drunk and/or impaired driving is unquestionably an enormous societal concern (Commission to Combat Police Corruption, 2009; Shults, Beck, & Dellinger, 2011), and evidence from anecdotes and journalistic investigations demonstrate that some police drive while impaired themselves

(e.g., Castaneda, 2008; Davis, 2008; Fazlollah, 2001, 2003). Aside from anecdotes and the reports of local journalistic investigations however, there are no systematic data on the problem of police DUI's. There are no official statistics on the number of officers arrested for DUI-related offenses, and only one study provides data that describe cases involving police who drive impaired on a national scale (see Stinson, Liederbach, Brewer, & Todak, 2014). Additional data are clearly necessary to understand and mitigate the problem.

The Problem of Drug-related Police Crime

A third type of police crime explored in this study is drug-related police crime. Police scandals during the last two decades of the twentieth century exposed dramatic cases of drug-related corruption in several major American cities. A report of the United States General Accounting Office (1998) outlined several different drug-related corruption scandals across the United States during this period. The most widely-recognized scandals occurred in Miami (Sechrest & Burns, 1992), Los Angeles (Los Angeles Police Department, 2000), and New York City (Baer, Jr. & Armao, 1995). The scandals within the NYPD gained particular notoriety because of both the visibility of the NYPD and the egregious crimes perpetrated by the involved officers. Investigations into the NYPD scandal discovered widespread drug-related corruption including police who burglarized drug dens, trafficked in stolen drugs, and robbed drug dealers and their customers (Baer, Jr. & Armao, 1995).

Twenty years ago the Mollen Commission (1994) highlighted the role of cocaine and crack markets in the production of drug-related police corruption in New York City. Whereas previous scandals usually arose within the context of payoffs tied to gambling or prostitution rackets, the Commission described how the burgeoning narcotics trade had become the source for more “aggressive, extortionate, and often violent” corruption that “parallel[ed] the violent

world of drug trafficking” (Baer, Jr. & Armao, 1995, p. 76). The Mollen Commission revealed how drug corruption tends to instigate various forms of misconduct and in some cases violent crimes perpetrated by police, at least as these cases unfolded within the largest police agency in the nation during the 1980s and 1990s. The patterns identified by the Mollen Commission suggest the need for more recent data to explore the incidence of drug-related police crime since the 1990s, and the degree to which drug-related police crime occurs within agencies across the nation.

The Problem of Violence-related Police Crime

A fourth type of police crime explored in this study is violence-related police crime. Crimes committed by police officers are by their nature special and deserving of scholarly attention because the law affords police unique rights and responsibilities, including the legal authority to use coercive force and access to weapons not available to ordinary citizens. The police are afforded unique opportunities for misconduct and crime that potentially involve violence including the excessive and/or illegal use of violence against criminal suspects and other citizens. This report describes the problem of violence-related police crime in two parts: (a) police crimes involving violence, and (b) cases in which police are arrested for crimes associated with domestic and/or family violence.

Police use of physical force is synonymous with police violence. Sherman (1980) defines police violence as behavior by any officer—acting pursuant to their authority and/or power as a sworn law enforcement officer—that includes any use of physical force (including, but not limited to, the application of deadly force), whether justified or unjustified, against any person. Many acts of police violence are never brought to the attention of law enforcement authorities and never disclosed to the public.

A second aspect of the problem of violence-related police crime involves what is commonly referred to as officer-involved domestic violence (Blumenstein, Fridell, & Jones, 2012; Gershon, 2000; Johnson, 1991; Johnson, Todd, & Subramanian, 2005; Sgambelluri, 2000; Stinson & Liederbach, 2013; Wetendorf, 2000). The movement to recognize officer-involved domestic violence gained momentum through the last two decades; and, incorporates provisions of the 1994 Violence Against Women Act that defined domestic violence as a national crime problem and the 1996 enactment of the Lautenberg Amendment to the federal Gun Control Act (18 U.S.C. § 925) prohibiting individuals—including police officers—from owning or using a firearm if they have been convicted of a misdemeanor crime of domestic violence (Lonsway & Harrington, 2003). In 1999, the International Association of Police Chiefs promulgated a model policy on the handling of officer-involved domestic violence cases and described domestic violence in police families as a problem that “exists at some serious level and deserves careful attention” (International Association of Chiefs of Police, 2003, p. 2). These and other initiatives have worked to establish officer-involved domestic violence as an important issue for police scholars and executives as well as the general public; but, there is still a lack of empirical data on the phenomenon.

The Problem of Profit-motivated Police Crime

Profit-motivated police crime involves officers who use their authority of position to engage in crime for personal gain (see, e.g., Kane & White, 2009, 2013; Stinson et al., 2010; Stinson, Liederbach, et al., 2012; Stinson, Todak, & Dodge, 2013). The Mollen Commission (1994) noted that greed is the primary motive behind corruption-based police crime. This is likely true in the traditional conceptualization of police corruption in the context of, for example, an officer accepting a bribe as payoff to refrain from law enforcement. It is less clear, however,

when an officer while either on- or off-duty sells drugs, shoplifts, commits burglaries or robberies, or engages in acts of insurance fraud. Fyfe and Kane (2006) recognized this conceptual problem and—in labeling their reconceptualization as profit-motivated police misconduct—urged future policing scholars and police administrators to rethink the notion of police corruption because “police corruption is not as easy to define as we formerly may have believed” (Fyfe & Kane, 2006, p. xv). Carter (1990a, 1990b) also conceptualized drug-motivated police corruption as characterized by a profit-driven cycle as one of two behavioral motivations. Stinson (2009) adopted profit-motivated police crime as the fifth type of police crime and noted that it is consistent with Ross’ (2001) taxonomy of police crime.

Literature Citations and Review

Our review of the relevant research literature proceeds from the general to the specific. First, we cover scholarship relevant to the conceptualization of police crime. These studies provide definitions for the focus of our research and an identification of the features that distinguish the phenomenon from the more general topics of police deviance, police misconduct, or police corruption. This part of the review also outlines studies that describe and specifically measure the more general forms of police deviance. These studies provide data on behaviors that sometimes—but not always—involve specific violations of the criminal law by police officers. The second portion of the review covers research literature more relevant to each of the five key types of police crime outlined in the preceding section of the report.

The Conceptualization of Police Crime

The study of police crime has thus far been hampered by a degree of conceptual confusion, mostly due to the tendency of police scholars to consider crimes perpetrated by officers *within* studies focused on the more generalized topics of police corruption, deviance, or misconduct. A quick review identifies the myriad of terms used to define each of these distinct topics. Wilson (1963) defines police criminality as “illegally using public office for private gain without the inducement of a bribe, whereas acts of corruption *do* involve the acceptance of bribes (p. 190). He further distinguishes police criminality and corruption from brutality, which includes “mistreating civilians or otherwise infringing their civil liberties” (p. 190). Punch (2000) distinguishes “crimes committed by criminals in uniform” from acts of police misconduct, which involve violations of administrative rules that are typically investigated and sanctioned internally by the police organization (pp. 302–303). Ross (2001) provides a multidimensional taxonomy of police crimes based in part on whether the act was (a) violent, (b)

motivated by profit, and/or (c) perpetrated on behalf of the individual or the organization.

Sherman (1978) focuses on corruption as a form of organizational deviance, and does not distinguish between police corruption and police crime.

Scholars have tended to consider acts of law violation together with other forms of police deviance that do not involve specific violations of the criminal law, as well as those whose legal status as crimes tends to shift over time, such as bribery (see, e.g., Anechiarico & Jacobs, 1996, pp. 6–7). Fyfe & Kane (2006) point out that the various forms of police deviance are not mutually exclusive—some forms of corruption and misconduct are police crime and all forms of police crime constitute misconduct. Crimes, however, that do not involve the misuse of authority cannot be defined as acts of corruption (Fishman, 1978). The distinction among the various forms of deviance is that *all* police crimes involve a violation of criminal statutes and are subject to criminal prosecution, but not all acts of police corruption or misconduct violate criminal laws (Wilson, 1963). The conceptual confusion stems largely from the failure to distinguish specific violations of the criminal law whether or not they constitute an abuse of authority. *The current study focuses on crimes committed by police officers that involved an arrest on at least one criminal charge* to avoid this confusion and focus scholarly attention on behaviors that have thus far remained invisible to researchers because they have often been lumped together with more general acts of corruption, deviance, and/or misconduct (Box, 1983; Jupp, Davies, & Francis, 1999; Kutnjak Ivkovic, 2005).

Most of what we know about police corruption and other forms of police deviance is from the investigations of independent commissions in the wake of police scandals including the Knapp Commission (1972) report, the Pennsylvania Crime Commission (1974) report, and the Mollen Commission (1994) report. These investigations were not designed to investigate police

crimes per se, but their findings in regard to corruption and other forms of misconduct shed some light on the crimes committed by officers. The commissions collectively demonstrated a problem that went well beyond the usual claim that police deviance is limited to a few “rotten pockets” of morally deficient officers, but their findings supplied only limited information on the true nature and extent of crimes committed by officers (Sherman, 1974, p. 7; Skogan & Frydl, 2004).

The Knapp Commission (1972) acknowledged that bribe-taking and petty thefts were pervasive. The investigation also identified small groups of officers referred to as “meat-eaters” who “spend a good deal of their working hours aggressively seeking out situations they can exploit for financial gain, including gambling, narcotics, and other serious offenses” (p. 65). Twenty years later, the Mollen Commission recognized a shift in the nature of corruption “primarily characterized by serious criminal activity” closely associated with the drug trade, including wide-scale drug abuse and trafficking among officers (Mollen Commission, 1994, p. 17). The trend was closely tied to an explosion of crime opportunities provided by open-air markets for crack cocaine that sprouted during the early 1990s.

Researchers have used police agency records to study officer misconduct that in some cases includes specific violations of the criminal law. Fyfe and Kane (2006) studied the career-ending misconduct of a sample of 1,543 New York City Police Department officers employed during the period 1975 through 1996 (see also Kane & White, 2009, 2013). They identified eight separate categories of career-ending misconduct, and found that officers commonly engaged in several different types of profit-motivated crime including bribe-taking, grand larceny, insurance fraud, burglary, petit larceny, receiving stolen property and welfare fraud.

Officers also engaged in a wide variety of crimes while they were off-duty, including domestic violence, driving while intoxicated, bar fights, and sexual offenses.

Discussions on the conceptualization of police crime lead naturally to debates on appropriate responses to the phenomenon including various forms of organizational and court-based dispositions. There is a limited body of empirical evidence in regard to factors that influence the imposition of organizational sanctions in cases of career-ending police misconduct based on the study of a sample of 1,543 NYPD officers employed from 1975 through 1996 (Fyfe & Kane, 2006; Kane & White, 2009, 2013). The research demonstrated that the NYPD was more likely to terminate employment in cases of serious misconduct where there was evidence that an officer violated the criminal law and/or a major administrative policy. The NYPD commonly used suspension(s) to respond to less serious forms of misconduct. The best predictors of career-ending police misconduct were disciplinary and reliability problems at previous jobs, prior criminal involvement, and the mean number of complaints against an individual officer per year. Overall, the imposition of some form of organizational discipline was most likely in cases where officers: (a) exhibited serious behavioral problems, and (b) violated rules that “conflicted with the proper functioning of the organization” (Kane & White, 2013, p. 163).

The existing research on organizational dispositions—based almost exclusively on the experience of NYPD officers—remains difficult to interpret in regard to generalizability and how police agencies nationwide respond to cases of police misconduct. The logical source of data on organizational dispositions are agency records and personnel files; but, these data are not commonly made available to researchers, the media, or the public. Kane and White (2013) summarize some more general limitations associated with the use of agency records in the study

of organizational responses to police misconduct. These data are in some ways inherently biased since they largely represent the organizational perspective on the process of discipline. Agency records also commonly present an incomplete picture of the disciplinary process. For example, police organizations often suggest resignation as an alternative to termination for officers involved in serious forms of misconduct, a situation that threatens the validity of data based exclusively on the final documented organizational disposition of these sorts of cases. Problems associated with generalizability and an overall dearth of data are exacerbated in regard to the issue of legal rather than organizational dispositions. We are aware of no existing studies focused on the legal disposition of police crime cases in terms of the imposition of adverse employment outcomes aside from those derived from data collected as part of the current project (e.g., Stinson, Liederbach, et al., 2013, 2012; Stinson, Brewer, Mathna, Liederbach, & Englebrecht, 2014; Stinson & Liederbach, 2013; Stinson, Liederbach, Brewer, & Mathna, 2014; Stinson, Liederbach, Brewer, & Todak, 2014; Stinson et al., 2010; Stinson, Todak, & Dodge, 2015; Stinson, Reynolds, & Liederbach, 2012; Stinson & Watkins, 2014). One primary goal of this project is to describe and analyze the organizational and legal disposition of cases of police crime, including officers arrested for crimes that related to sex, alcohol, drugs, violence, and/or were profit-motivated.

In *Garrity v. New Jersey* (1967) the United States Supreme Court discussed the difference between adverse employment actions in the nature of disciplinary investigations against officers for police misconduct and initiation of criminal proceedings against a police officer for the same underlying event. The Court held that a police officer is required to answer questions truthfully in internal disciplinary investigations where the officer would be subject to termination for failing to answer the questions, but that statements made in that context by a

police officer cannot then be used in any criminal proceeding against the officer because the statements were coerced. As a result, many investigations into police misconduct that potentially involve police crime are stymied because a decision must be made by police administrators whether to (a) elect to gather information by questioning an officer in a disciplinary matter, or (b) forego any questions of an officer administratively and proceed with a criminal investigation against the officer. If the second option is elected, then the officer would be entitled to the right against self-incrimination that is afforded to any suspect or defendant in a criminal investigation pursuant to the Court's holding in *Miranda v. Arizona* (1966). In some instances, law enforcement agencies simply allow an officer to resign in lieu of initiation of criminal proceedings against a sworn officer as an effort by the agency to quietly resolve a matter without public disclosure of police misconduct.

Review on Sex-related Police Crime

The first type of police crime explored in this study is sex-related police crime. Scholarship on the topic has been comparatively sparse. Early studies focused broadly on behaviors that constituted police sexual misconduct and acts such as on-duty consensual sex between officers and female adult citizens. Barker (1978) surveyed police officers who indicated that consensual sex on-duty was quite prevalent, especially in patrol cruisers. Sapp (1994) provided data derived from in-depth interviews of police. The study included qualitative—sometimes lurid—descriptions of seven different forms of police sexual misconduct, including cases wherein police spent entire shifts seeking opportunities to view unsuspecting females partially clad or nude, the sexual harassment of crime victims and criminal suspects, and sexual contacts between officers and underage females. Some of the behaviors described within the

Sapp study clearly involved sexual coercion rather than consensual sex between police and willing citizens.

Kraska and Kappeler's (1995) exploratory study on police sexual violence incorporates a wide continuum of behaviors that range from comparatively unobtrusive forms of sex-related misconduct (e.g. voyeurism and other invasions of privacy) to obtrusive forms of sexual violence (e.g. sexual assault and rape). Kraska and Kappeler study the phenomenon within the context of existing police scholarship *and* scholarship derived from the feminist literature that more clearly defines police sexual violence as a form of gender bias and the systematic differential treatment of females in the criminal justice system. They identified 124 cases of police sexual violence through both published news reports and federal lawsuits arising under 42 U.S.C. §1983 involving police accused of sexual misconduct. Close to one-third of the cases (30%) identified involved rape and/or sexual assault. More than one-half of the cases involved strip searches. Published news reports tended to identify more serious forms of police sexual violence, while cases that involved strip searches and less serious acts were more likely to be identified through the federal lawsuit data. Cases of police sexual violence were widely dispersed geographically, and Kraska and Kappeler (1995) suggest that the cases identified in their study were likely the “tip of the iceberg” (p. 97). They indicated that the organizational and occupational culture of policing provides officers ample opportunity to engage in sex-related misconduct and crime, and note the obstacles to reporting these forms of misconduct confronted by victims including the fear of retaliation and forms of secondary victimization similar to that experienced more generally by victims of sexual assaults (see, e.g., LaFree, 1989).

More recently, Maher provided data on police sexual misconduct derived from surveys of both officers (Maher, 2003) and police chiefs (Maher, 2008). Surveys of officers demonstrate

that they believe less serious forms of sexual misconduct occur frequently, and are facilitated by the opportunity structure provided by the job. The majority of officers indicated that they had not been pressured to engage in acts of sexual misconduct, but, they were unlikely to report less serious forms of the phenomenon. Surveyed police chiefs believed that less serious forms of sexual misconduct were common and serious forms of sexual misconduct and crime were rare. The data suggest that most police agencies do not have any written policies that expressly prohibit sexual misconduct (Maher, 2008). Walker and Irlbeck (2002) describe cases that they refer to as "driving while female," wherein police initiate bogus traffic stops to harass, intimidate, and/or sexually assault female motorists.

Rabe-Hemp and Braithwaite (2013) recently published a study focused on police sexual violence and the problem of officer shuffle, wherein police involved in various forms of sexual misconduct and crime escape punishment and maintain their law enforcement career through employment with another police agency. Data were derived through a content analysis of published newspaper accounts of police sexual violence from 1996-2000. They identified 106 cases of police sexual violence. Close to one-half (41.5%) of the cases involved repeat police perpetrators. Repeat offenders were more likely than first time offenders to victimize juveniles.

Review on Alcohol-related Police Crime

The second type of police crime covered in this study is alcohol-related police crime. This report describes the problem of alcohol-related police crime in terms of both the off-duty consumption of alcohol and the phenomenon of police DUI. As we previously described, virtually all of the existing empirical data on off-duty police misconduct describes the misbehavior of NYPD officers primarily through the reports of the Commission to Combat Police Corruption (1998b, 2004). The Commission recommended specific policies designed to

mitigate problems associated with off-duty alcohol abuse, including provisions to expand the definition of unfit for duty to include intoxicated off-duty officers and prohibitions against carrying an off-duty weapon while intoxicated (Commission to Combat Police Corruption, 1998b). Fyfe and Kane's (2006) classification of police misconduct includes driving while intoxicated within the category of off-duty public order crimes, but they do not provide specific data that distinguishes misconduct that includes the abuse of alcohol. Kane and White (2009) provide several descriptions of cases that involved intoxicated off-duty officers engaged in bar fights, drunk driving, and personal disputes.

Despite the findings of Kane and White (2009), the lack of existing scholarship on alcohol-related police misconduct and crime is even more acute in the specific case of police DUI. Reviews of the empirical literature failed to uncover any scholarly research specifically focused on the phenomenon of police DUI other than the research by Stinson, Liederbach, Brewer, and Todak (2014) using data from the current study on police crime. Some recent evidence indicates that officers and agencies often minimize or ignore the problem of impaired driving among police. A Bureau of Justice Statistics (BJS) survey reported that over one-third of responding state and local police agencies *would* consider police applicants with a prior DUI conviction (Reaves, 2012). Additionally, a majority of officers responding to a survey on police integrity said they *would not* report a fellow officer who had a minor traffic accident while driving under the influence of alcohol (Klockars, Kutnjak Ivkovic, Harver, & Haberfield, 2000). Recent journalistic investigations in Milwaukee (Barton, 2011), Denver (McGhee, 2011), and New York City (Paddock & Lesser, 2010) reported disturbing cases in which police found to have driven drunk were either not arrested and/or otherwise minimally punished.

Scholars have long recognized the existence of alcohol-related problems in policing and have identified factors that seem to promote excessive drinking among police (Dietrich & Smith, 1986; Dishlaccoff, 1976; Hurrell, Jr. et al., 1984; Violanti, Marshall, & Howe, 1985). Violanti et al. (2011) group these factors in terms of (a) officer demographics, (b) stress, and (c) police culture. Excessive alcohol consumption is certainly due at least in part to demographics and the over-representation of young males among police officers, in particular patrol officers. Men are more likely to have problems with alcohol than women, and alcohol use disorders are most prevalent among 18-24 year-olds (National Institute on Alcohol Abuse and Alcoholism, 2008). Age and gender have also been specifically correlated with drinking and driving. Alcohol dependence at the age of 21 has been found to significantly predict persistent driving while drinking episodes (Begg, Langley, & Stephenson, 2003) and young adult males have been found to be significantly more likely to engage in driving while drinking than other cohorts (Chou et al., 2006).

There is an extensive line of research on how stress may influence excessive drinking among police. Abdollahi (2002) provides a comprehensive overview of this literature in terms of factors that include (a) intra-interpersonal stressors, (b) job-related stressors, and (c) organizational stressors. Violanti et al.'s (2011) survey of police found that stress derived from failed interpersonal relationships increased the likelihood of hazardous drinking behavior, especially among male officers. A number of studies attribute excess alcohol consumption to the failure to properly cope with stress that is related more specifically to the job, including those derived from a perceived lack of organizational support and problematic encounters with citizens (Anshel, 2000; Ayres, Flanagan, & Ayres, 1992; Kohan & O'Connor, 2002). Leino et al. (2011) recently explored how job-related exposure to violence and the absence of adequate debriefing

procedures may increase levels of drinking among police. Swatt, Gibson, and Piquero (2007) utilize Agnew's general strain theory to explain how anxiety/depression mediate the relationship between work-related strain and drinking prevalence among police officers.

Studies focused on the drinking behavior of police also underscore the impact of police culture. Police culture has been referred to as essentially a drinking culture that often includes frequent social interactions that involve the consumption of alcohol (Violanti et al., 1985). Various occupational factors have been found to increase the risk of alcohol and drug problems (Fennell, Rodin, & Kantor, 1981; Hingson, Mangione, & Barrett, 1981). Indeed, Macdonald, Wells, and Wild (1999) specifically found that the existence of a drinking subculture at work was associated with the development of alcohol problems. Lindsey and Shelley (2009) found that police officers most at risk for drinking problems admitted that fitting in was the primary reason they engaged in alcohol consumption. Officers may also be discouraged from reporting problem drinking or drunk driving among fellow officers in order to uphold other widely-recognized values shared among police including secrecy and solidarity (Banton, 1964; Skolnick, 1994).

Review on Drug-related Police Crime

The third type of police crime covered in this study is drug-related police crime. This line of research covers three relevant issues including (a) the etiology of drug-related misconduct, (b) the classification of drug-related misconduct, and (c) the prevalence of drug use by police. Police scholars typically attribute drug-related corruption to factors associated with the organization of police work and the occupational culture of police. Stoddard (1968) emphasizes the role of police culture and the nature of police work in the causation of what he referred to as blue coat crime. Kraska and Kappeler (1988) underscore the prevalence of on-the-job opportunities for patrol officers to become involved in the drug trade in some fashion,

including lack of direct supervision, drug availability, and exposure to drug users and dealers. The report of the General Accounting Office (1998) highlights the influence of deviant police subcultures that both promote drug corruption and protect police who adhere to deviant subcultural norms such as secrecy, loyalty, and cynicism about police work and the criminal justice system. Carter and Stephens (1994) view substance abuse as primarily a “job-related condition” among police, particularly those working undercover vice in drug-infested beats (p. 107).

Carter (1990b) provides the most often cited classification scheme for drug-related corruption. His typology identifies two forms of drug corruption. Type 1 or traditionally-conceptualized drug corruption involves officers motivated by illegitimate goals including personal profit. This form of drug corruption includes the extortion and robbery of drug dealers and the acceptance of bribes to protect them. Type 2 drug corruption is comprised of officers motivated by organizationally-derived legitimate goals ostensibly tied to the arrest and conviction of dealers and users. This form of drug corruption includes perjury, violations of criminal procedure, and the planting of criminal evidence. Aside from its utility as an organization scheme, Carter's typology demonstrates how the drug trade tends to give rise to many different forms of police crime. The drug trade provides opportunities for personal gain through payoffs, shakedowns, robberies, and opportunistic thefts, as well as types of misconduct tied to drug enforcement goals and violations of the rights of criminal defendants including perjury and the planting of evidence. Officers who are recreational drug users expose themselves to street-level dealers and associated manipulation and coercion (Kappeler et al., 1998). Carter's (1990b) conclusions about the impact of these markets on the nature of police corruption closely mirror those of the Mollen Commission (1994) by noting that “the nature of

corruption has changed, particularly with respect to police drug users, the emergence of crack houses as easy targets, and the frustration with drug-law enforcement associated with the extraordinarily high volume of drug traffic” (Carter, 1990b, pp. 96–97).

Very little is known about the prevalence of drug use among police officers (Mieczkowski, 2002). Kraska and Kappeler (1988) provide what is widely-cited as the only empirical description of on-duty drug use by police through their study of one medium-sized police agency. They found that 20% of the officers used marijuana on duty at least two times per month, and that 10% had used other non-prescribed controlled substances while on duty, including hallucinogens, stimulants, and/or barbiturates. The study provides initial evidence to suggest that the problem of on-duty drug use by police is not limited to large urban departments, although data derived from a much larger sample of agencies is needed to assess the prevalence of drug use among police across various types of jurisdictions.

Official drug tests provide another source of data on the degree to which police use drugs, but most of this evidence describes testing results from a single agency, and no entity collects comprehensive data on the number of police who test positive overall. One journalistic investigation reported a 1.1% failure rate (75 officers) among Boston Police Department police tested from 1999-2006, as well as the failure of 14 Los Angeles Police Department officers drug tested from 2000-2006. Over 81% of the positive tests in Boston involved the use of cocaine, and police executives indicated that they believed cocaine had surpassed marijuana as the drug of choice among police (Smalley, 2006). More recent data derived from self-report surveys of officers in a single agency in Australia suggest that police use a wider variety of drugs including marijuana, amphetamines, cocaine, ecstasy, heroine, ketamine, and non-prescribed steroids (Gorta, 2009).

Lersch and Mieczkowski (2005a) report results of drug tests conducted in a large police agency in the Eastern United States in which very few officers tested positive (~ .005%). Scholars often point out, however, that official drug tests are likely influenced by (a) “announcement effects” and the fact that officers employed by these agencies are aware of testing protocols (Lersch & Mieczkowski, 2005a, p. 292), and (b) the method of drug testing. Cocaine is the most frequently detected drug based on hair analysis, and marijuana is the most frequently detected drug based on urinalysis (Lersch & Mieczkowski, 2005a; Mieczkowski, 2002; Mieczkowski & Lersch, 2002).

Review on Violence-related Police Crime

The fourth type of police crime explored in this study is violence-related police crime. According to Sherman (1980), police use of physical force is synonymous with police violence, defining police violence as behavior by any police officer—acting pursuant to their authority and/or power as a sworn law enforcement officer—that includes any use of physical force (including, but not limited to, the application of deadly force), whether justified or unjustified, against any person. Based on Sherman’s definition, explanations for police violence in the existing literature have been quite varied (e.g., Alpert & MacDonald, 2001; Garner, Maxwell, & Heraux, 2002; Griffin & Bernard, 2003; Lersch & Mieczkowski, 2005b; Manzoni & Eisner, 2006; Terrill & Mastrofski, 2002; Terrill, Paoline, & Manning, 2003; Terrill & Reisig, 2003). Stinson, Reynolds, and Liederbach (2012) use data from the current study to identify and describe cases that involve the criminal misuse of conductive energy devices—purportedly a less-than-lethal alternative to firearms—so studies that describe the factors that influence police use of force more generally during citizen encounters seem particularly relevant.

Police scholars have examined the factors that influence the use of force more generally since the 1960s, and quantitative studies have focused on the relationship between police force and a wide range of predictors including situational, individual, organizational, and community-level variables. Overall, virtually all studies that compare situational factors to others such as officer, organizational, and community-level factors have found that situational factors exert the most powerful influence on the decision to use coercive force (Skogan & Frydl, 2004). Police are more likely to resort to violence in encounters that include physically aggressive suspects and citizens who resist officer attempts to control the situation. Researchers have most often investigated the influence of situational factors in cases that involve the use of deadly force by police (e.g., Alpert & Smith, 1999; Binder & Scharf, 1982; Blumberg, 1983; Fyfe, 1981). This line of research has primarily emphasized the direct relationship between the level of situational risk faced by an officer and the specific decision to employ deadly force. Situational risk refers to the immediate scenario within which police must decide to shoot or not shoot. Did the suspect assault the police? Was the suspect armed? Did the suspect shoot at police? These situational factors appear to explain the use of deadly force more directly than other variables. Terrell's (2003) research based on observational data suggests that situational factors are also the primary determinants of the use of non-deadly force by police. He examined the relationship between five levels of suspect resistance (none, passive, verbal, defensive, and active), and four levels of non-lethal force (none, verbal, restraint, and impact) and found that force levels were significantly related to levels of suspect resistance.

The review to this point has outlined prior research that examines the general use of police force and its predictors, whether situational, individual, organizational, and/or community-level factors. Distinctions as to whether the use of police force in a particular case will be

defined as “justified” or “excessive” or perhaps even “criminal” are subjective and are made case-by-case based largely on the discretionary decisions of actors within the criminal justice system, including police and prosecutors. Most states provide guidelines for the police use of force in existing criminal codes, and local prosecutors may choose to prosecute police who engage in behavior that violates the criminal law. The level of force used to complete an arrest or otherwise protect public safety must be commensurate with the crime committed and proportionally related to its necessity (Cheh, 1996; Klockars, 1996). Police officers who use “excessive” levels of force may be criminally prosecuted for a range of offenses including homicide, manslaughter, and assault. Comprehensive statistics on the criminal prosecution of police are generally neither maintained nor available to scholars or the public, so an empirically-based identification of the specific factors that distinguishes cases on the basis of whether force was “justified” or “criminal” is not currently possible. One primary goal of the this project is to utilize media-based data in order to identify and describe cases of violence-related police crime that are distinguished by the fact that they involved the *criminal arrest* of a police officer(s) and were thus defined by the system as “criminal,” at least prior to the adjudication phase of the case.

This type of police crime also incorporate cases that involve police arrested for crimes associated with domestic and/or family violence, a phenomenon increasingly referred to in the research literature as officer-involved domestic violence. There have been very few empirical studies designed to estimate the prevalence of officer-involved domestic violence—all of them based on self-administered surveys of police and/or their spouses. Johnson (1991) reported that 40% of responding officers admitted that they had behaved violently toward their spouse at least once during the previous six months, and 20% of the spouses in a concurrent survey reported that their spouse had abused either them or their children in the previous six months. Neidig, Russell,

and Seng (1992) and Neidig, Seng, and Russell (1992) reported that 41% of responding male officers admitted that at least one incident of physical aggression occurred in their marital relationship during the previous year, and 8% of those reported the occurrence of “severe” physical aggression including choking, strangling, and/or the use or threatened use of a knife or gun (Neidig, Russell, et al., 1992, p. 32). Reported rates of officer-involved domestic violence are highest among officers who are currently divorced or separated from their spouses.

The literature on officer-involved domestic violence is filled with anecdotes that underscore the occupationally-derived etiology of violence within police families. Factors associated with police culture and the job that have been discussed within the context of officer-involved domestic violence include: (a) violence exposure, (b) authoritarianism, and (c) problem drinking. Researchers suspect higher rates of domestic violence among police most exposed to work-related violence based on studies that document a relationship between violence exposure and the personal well-being of police officers; and, the research literature on the relationship between work and family and the possibility of spillover effects (Johnson et al., 2005; Mullins & McMains, 2000). Officer surveys identify violence exposure as one of the most significant work-related stressors for police (Gershon, 2000), and studies based on clinical trials describe links between police stress and poor family functioning (Neidig, Russell, et al., 1992). Police training in authoritarian styles and the regular exercise of coercive force may influence marital interactions and promote domestic and/or family violence (Greene-Forsythe, 2000; Johnson, 1991; Johnson et al., 2005; Sgambelluri, 2000).

Police are trained to exert power and use coercive force to accomplish their goals and gain compliance from citizens (Bittner, 1978; Skolnick, 1994). The regular exercise of coercion and authoritarianism may spillover to the home in cases where police treat family members as

criminal suspects. Johnson (1991) identified a link between authoritarian spillover and high levels of strain in police families; and, Johnson et al.'s (2005) survey of police indicates that authoritarian spillover mediates the relationship between exposure to violence on the job and domestic violence among police. Problem drinking is another aspect of the work-family spillover that may contribute to the incidence of violence in police families. The research that associates officer-involved domestic violence with problem drinking cite many of the same occupationally-derived factors covered in the previous section on alcohol-related police crime including (a) intra-interpersonal stressors, (b) job-related stressors, and (c) organizational stressors.

Much of the remaining research literature on officer-involved domestic violence focuses on the unique vulnerabilities of domestic violence victims in police families and factors that conspire to discourage exposure of these crimes and contribute to the hidden nature of the problem. While scholars have long demonstrated that victims of domestic and/or family violence are often reluctant to officially report these crimes, the fact that perpetrators of officer-involved domestic violence are police themselves creates particular problems and barriers to reporting. First, they must consider the fact that perpetrators possess and are trained to use lethal weapons. Second, police perpetrators are likely to know the location of domestic violence shelters and have professional experience that can be used to manipulate the system and shift blame to the victim (Gershon, 2000; National Center for Women & Policing, 2005). Third, decisions to report incidents of officer-involved domestic violence are also likely influenced by the cultural values of secrecy and loyalty, wherein police (and their families) are expected to “never blow the whistle” and expose police perpetrators (Johnson et al., 2005; Shernock, 1995, p. 623). Fourth, domestic violence victims in police families also may be concerned about

consequences associated with provisions of the Lautenberg Amendment (1996) that prohibit police from owning or using a gun if they are convicted of a misdemeanor crime of domestic violence.

Review on Profit-motivated Police Crime

The Mollen Commission (1994) found that greed is the primary motive behind police crime that constitutes corruption. This is true if police corruption is conceptualized in the traditional context of acts such as accepting bribes to refrain from law enforcement. It is, however, “less clear whether officers who perform robberies or burglaries, shoplift, sell drugs, or engage in welfare or insurance fraud during their off-duty time are engaging in a variety of police corruption” (Fyfe & Kane, 2006, p. xv). Fyfe and Kane (2006) reconceptualized these actions as “profit-motivated misconduct” and noted that “police corruption is not as easy to define as we formerly may have believed (p. xv). Similarly, Carter (1990b, pp. 89–90) conceptualized police corruption as being characterized by a “profit-driven cycle.” The classification of some police crime as profit-motivated is also found in Ross’ (2001) taxonomy of police crime, where the second of four dichotomous distinctions is between “economically-motivated and noneconomically-motivated police behavior” (p. 184).

Using the same data set as Fyfe and Kane (2006), Kane and White (2013) explored the nature of the career-ending police misconduct in the NYPD and found that the profit-motivated cases ($N = 387$) included bribe-taking (18.6%), grand larceny (17.1%), insurance fraud (8.6%), burglary (7.3%), petit larceny (7.3%), receiving stolen property (3.9%), government fraud (3.1%), gratuities (2.6%), gambling (1.8%), illegal operation (1.8%), and other profit-motivated misconduct (27.4%) such as extortion, robbery, abusing official resources (p. 73, Table 4.2).

Stinson and colleagues found that profit-motivated police crime is a quantifiable variable that helps explain the nature of police crime across the life course of officers' law enforcement careers in a variety of contexts at nonfederal law enforcement agencies across the United States. Whereas less experienced police officers are more likely to commit violent crimes, those officers who commit profit-motivated crimes are more likely to be experienced officers late in their policing career and more likely to be supervisors and/or administrators (Stinson et al., 2010). Likewise, crime by policewomen is most often profit-motivated (Stinson, Todak, et al., 2013). Crime by school resource officers typically is not profit-motivated police crime (Stinson & Watkins, 2014). Profit-motivated police crimes are more likely to be committed while on-duty and less likely to be committed while an officer is off-duty (Stinson, Liederbach, et al., 2012).

Statement of Rationale for the Research

The purpose of the current research project is to promote police integrity by gaining a better understanding of police crime and agency responses to officer arrests. The study is providing a wealth of data on a phenomena that relates directly to police integrity—data that police executives did not previously have access to because they did not exist in any useable format.

The first goal of this research is to determine the nature and extent of police crime in the United States. Objectives for this goal are to: (a) identify and describe the incidence of officers arrested during each year in the study period; and (b) identify and describe the prevalence of officers arrested over the course of the study period.

A second goal of this research is to determine what factors influence how a police organization responds to arrests of officers. Objectives for this goal are to: (a) identify, describe, and analyze the severity of crimes for which police officers are arrested and determine whether

severity of crime influences employment outcomes; (b) identify and analyze the level of urbanization for each employing police organization by using a 9-level urban-to-rural continuum scale to determine whether an agency's degree of urbanization or rurality influences agency response and employment outcomes; (c) identify and analyze the geographic location (region, division, and state) for each employing police organization to determine whether geographic disparity influences agency response and employment outcomes; (d) identify and analyze length of service and age of arrested officers to further investigate whether age in years and/or years of service influence agency response and employment outcomes; and (e) identify and analyze criminal case outcomes for each officer arrested to determine whether this factor influences agency response and employment outcomes.

A third and final goal of the research is to foster police integrity by exploring whether police crime and officer arrests correlate with other forms of police misconduct. Objectives for this goal are to: (a) identify and analyze whether the arrested officers in our database were also named individually as a defendant in any federal court civil actions pursuant to 42 U.S.C. §1983 during the life course of their law enforcement careers; and (b) inform police practitioners and policymakers of strategies derived from the project's findings that could improve early intervention systems and other internal controls to better identify problem officers and those at risk for engaging in police misconduct – including engaging in police crime creating potential agency exposure to civil liability – and its correlates.

The rationale for the current study evolved from long-standing obstacles associated with the collection of data on police crime. The underlying reasons for the current study reflect the ongoing lack of empirical data on the crimes committed by police—a situation that relates directly to the limitations of previous methodologies used to collect data on the phenomenon.

Researchers have resorted to a variety of methodologies to learn more about the nature and extent of police misconduct, corruption, and/or crime; but, empirical scholarship has usually incorporated one or more of the following: (a) officer surveys, (b) agency records, and (c) sociological field studies. Studies that utilize one or more of these methodologies have clearly contributed to the knowledge base on police crime, but the methodology used in the present study offers clear advantages in terms of both the scope and quality of potential data on police crime. The first part of this section provides a brief overview of those limitations by method. This overview is followed by a concise description of the advantages of our methodology. These advantages provide the basis of and rationale for our research on police crime.

Limitations of Surveys, Agency Records, and Field Research

Surveys have been perhaps the most commonly utilized method to collect data on the closely related problems of police corruption and police misconduct. Since the phenomena of police crime, police corruption, and police misconduct are analogous and sometimes overlapping, some survey research does provide limited insight into the measurement of police crime. There are two primary limitations associated with the utilization of surveys in regard to the study of police crime, corruption, and misconduct. The first problem relates to gaining access to police organizations to collect data on these issues. Researchers have long reported problems in gaining access and maintaining access to law enforcement agencies for research purposes (see, e.g., Kutnjak Ivkovic, 2005; Lundman & Fox, 1978, 1979), so researchers have been afforded comparatively few opportunities to openly ask police officers about their perceptions of or tolerance for various forms of misconduct—let alone their perpetration of actual criminal behavior (Barker, 1978; Kutnjak Ivkovic, 2003). In fact, none of the survey research reported in the literature directly measures police crime. Rather, the studies measure

correlates of police crime and tend to indicate the level of tolerance for such misconduct within some police agencies (see, e.g., Fishman, 1978). The second limitation of surveys in regard to the study of police crime involves validity and problems associated with the propensity to provide socially desirable responses to inquiries about misconduct, wrongdoing, and/or criminal behavior. There are some indications that police administrators and other police personnel may be less than truthful in responding to surveys by exaggerating (Maguire & Uchida, 2000). There are obvious problems associated with asking police officers to complete questionnaires with items on the nature and extent of police offending, because it is widely assumed that officers will maintain a code of silence and fail to disclose the nature and extent of police crime through a survey format (Fishman, 1978).

Researchers have also utilized agency and other official records to study issues associated with police misconduct, corruption, and crime. This line of research includes numerous cross-sectional studies based on small single agency samples of police officers. More recently, Fyfe and Kane (2006) provide longitudinal data on the misconduct and crime of police based on official agency records derived from the NYPD. The NYPD data compared the personal and career histories of all 1,543 NYPD officers who were involuntarily separated from the NYPD for cause from 1975 to 1996 with a random sample of their police academy classmates. The study methodology offers unique opportunities to describe and measure police misconduct and crime from single agencies over comparatively long time periods. Studies based on agency records have two primary limitations. First, similar to officer surveys, these data require difficult to obtain access to a police organization. Most police agencies are obviously reluctant to disclose official records of officer misconduct and crime to researchers. As a result, studies based on agency records almost invariably describe the misbehavior and crime of officers from a single

police agency, a situation that leads to issues in regard to the generalizability of studies based on data from a single police agency. A second limitation of using agency records is that they result from a filtering process within the organization that created the records. That is to say, agency records are the version of events from the perspective of the organization.

Reiss' (1971) classic research on the behavior of police officers in Chicago, Boston, and Washington DC stands as the only published study that utilized field observations to specifically describe various forms of police misconduct and crime. Reiss found that roughly 20% of observed police engaged in on-duty crime, not including assaults and syndicated crime. Most of the observed police crime was limited to thefts. Large scale observational studies of police are costly and difficult to conduct, so only a small number have been completed (Bayley & Garofalo, 1989; see, .e.g., Black & Reiss, 1967; Frank, Novak, & Smith, 2001; Liederbach, 2005; Liederbach & Frank, 2003; Mastrofski et al., 1998). Small scale observation studies are nonsystematic and often involve ride-along observations in one single agency. Field observations are also limited by the danger of reactivity, wherein officers may alter their behavior because of the presence of a civilian observer. Reactivity poses clear problems in the collection of observational data on police misconduct, corruption, and/or crime.

METHODS

Data for the current study were collected as part of a project commenced in the year 2004 designed to locate cases in which sworn law enforcement officers had been arrested for any type of criminal offense(s). Data were derived from published news articles using the Google News search engine and its Google Alerts email update service. Google Alerts searches were conducted using the same 48 search terms developed by Stinson (2009). The Google Alerts email update service sent a message each time one of the automated daily searches identified a news article in the Google News search engine that matched any of the designated search terms. The automated alerts contained a link to the URL for the news articles. The articles were located, examined for relevancy, printed, logged, and then scanned, indexed, and archived in a digital imaging database for subsequent coding and content analyses. The present study focuses on the identification and description of the cases in which police officers were arrested during the years 2005-2011.

Coding and Content Analysis

Content analyses were conducted in order to code the cases in terms of (a) arrested officer, (b) employing nonfederal law enforcement agency, (c) each of the charged criminal offenses, (d) victim characteristics, (e) organizational adverse employment outcomes, and (f) criminal case dispositions. Each of the charged criminal offenses was coded using the data collection guidelines of the National Incident-Based Reporting System (NIBRS) as the coding protocol for each criminal offense category (see U.S. Department of Justice, 2000). Fifty-seven criminal offenses are included in the NIBRS, consisting of 46 incident-based criminal offenses in one of 22 crime categories as well as 11 additional arrest-based minor criminal offense categories. In each case every offense charged was recorded on the coding instrument as well as

the most serious offense charged in each police crime arrest case. The most serious offense charged was determined using the Uniform Crime Report's (UCR) crime seriousness hierarchy (see U.S. Department of Justice, 2004). An additional eight offenses were added following an earlier pilot study (see Stinson, 2009) because police officers who were arrested often were charged with criminal offenses not included in the NIBRS (e.g., online solicitation of a child, indecent exposure, official misconduct / official oppression / violation of oath, vehicular hit-and-run, perjury / false reports / false statements, criminal deprivation of civil rights).

The primary unit of analysis in this study is criminal arrest case. One of the primary issues in coding was differentiating between arrest cases with multiple victims and officers who were arrested on multiple occasions within the study years 2005-2011. The remainder of this paragraph presents hypothetical situations to demonstrate the unit of analysis in this study. Assume, for example, that an officer was arrested for assaulting his wife. That is coded as one arrest case (arrest case #1). If the same officer was again arrested a week later for violating an order of protection (arrest case #2) that was issued by a court judge following the officer's first arrest, the second arrest was treated as a separate case in this study. If that same officer was arrested a few months later for drunk driving, that too was recorded as a new arrest case (arrest case #3). The officer was suspended from his employment immediately following his arrest for DUI. For the purposes of this hypothetical, assume that the same officer was acquitted at trial in all three of those arrest cases (that is, arrest case #1, arrest case #2, and arrest case #3) and returned to duty as a police officer. Two years later, let's assume that the same officer was arrested for sex crimes involving a 14 year-old victim (arrest case #4) and 15 year-old victim (arrest case #5). Further assume that the officer was convicted in the case involving the 14 year-old victim (arrest case #4), and the charges were dismissed by the prosecutor in the criminal case

involving the 15 year-old victim (arrest case #5). Following the officer's conviction (in arrest case #4), the officer was fired from the police department. By coding each arrest case separately, the criminal case dispositions in each case as well as the adverse employment actions attached to each arrest case can be documented for analysis.

Cases were also coded on Stinson's (2009) typology of police crime, which posits that most crime committed by police officers is alcohol-related, drug-related, sex-related, violence-related, and/or profit-motivated.¹ The types of police crime are not mutually-exclusive categories. Rather, each type of police crime is coded as a dichotomous variable because crimes committed by officers often involve more than one type of police crime. In a case where an officer was arrested and charged with the forcible rape of a female motorist during a traffic stop, for example, the case would be coded in this study as both sex-related and violence-related. Additionally, cases were coded for the presence of police sexual violence and/or driving while female encounters. Police sexual violence is operationalized as "those situations in which a female citizen experiences a sexually degrading, humiliating, violating, damaging, or threatening act committed by a police officer through the use of force or police authority" (Kraska & Kappeler, 1995, p. 93). Driving while female is operationalized as instances where a police officer stops a female driver under the pretext of an alleged traffic violation and then abuses the power and authority of his position to take advantage of a vulnerable motorist (Walker & Irlbeck, 2002, 2003). Walker and Irlbeck (2002) conceptualized the problem of driving while female as a parallel to the problem of racial profiling of African-American motorists often referred to as driving-while-black (cf. D. A. Harris, 1997, 1999). In the context of driving while female encounters, an officer typically asks for sexual favors in exchange for dropped charges or in lieu

¹ A sixth type of police crime not yet explored is revenge-motivated police crime.

of being taken to jail in a forced quid pro quo. In some cases, driving while female encounters escalate into sexual harassment, sexual assault, and in rare instances, forcible rape.

Cases were coded on numerous variables relating to police DUI arrest cases (see Stinson et al., 2010), off-duty police crimes (see Stinson, Liederbach, et al., 2012), drug-related police crimes and drugs of abuse (see Stinson, Liederbach, et al., 2013), and officer-involved domestic violence (see Stinson & Liederbach, 2013). Cases were also coded to assess each arrested officer's history of being named as a party-defendant in federal civil rights litigation pursuant to 42 U.S.C. §1981 (asserting a denial of equal rights under the law), 42 U.S.C. §1983 (asserting a civil rights deprivation under the color of law), and 42 U.S.C. §1985 (asserting a conspiracy to interfere with civil rights). The master name index in the federal court's Public Access to Courts Electronic Records (PACER) system to search and cross-reference the names of each arrested officer in our database to measure official capacity civil rights litigation as a correlate of police misconduct. Data from PACER were also recorded on civil actions removed from state trial courts to a United States District Court pursuant to the provisions of 28 U.S.C. §1441 (removal of civil actions).

Secondary data were employed from the Census of State and Local Law Enforcement Agencies (CSLLEA) to ascertain demographic data including the number of full-time sworn personnel and part-time sworn personnel employed by each agency where arrested officers served. There are 52 agencies included in this study that were not listed in the 2008 wave of the CSLLEA. County (and independent city) five-digit FIPS identifier numbers were used to verify location of arrested officers' employing law enforcement agencies, as well as for use as a key variable to merge other data sources into the project's master database and data set. The U.S. Department of Agriculture's (2003) county-level urban to rural nine-point continuum scale was

used to measure rurality. Population data from the U.S. Census Bureau's decennial census in years 2000 and 2010 were utilized for county, independent city, and state populations.

Reliability

Analytic procedures were undertaken to ensure reliability of the data. An additional coder was employed to independently code a random sample of five percent of the total number of cases in the study. Intercoder reliability was assessed by calculating the Krippendorff's alpha coefficient across 195 variables of interest in this study on a random sample ($n = 290$, 4.3%) of the cases in the study ($N = 6,724$) (see Hayes & Krippendorff, 2007). Krippendorff's alpha is often recognized as the standard reliability statistic for content analysis research (Riffe, Lacy, & Fico, 2005). The Krippendorff's alpha coefficient (Krippendorff's $\alpha = .9153$) is strong across the variables in this study (see Krippendorff, 2013). The overall level of simple percentage of agreement between coders across all of the variables in this study (97.7%) also established a degree of reliability well above what is generally considered acceptable in content analysis research (see Riffe et al., 2005).

Statistical Analysis

Chi Square is used to measure the statistical significance of the association between two variables measured at the nominal level. Cramer's V measures the strength of that relationship with values that range from zero to 1.0 and allows for an "assessment of the actual importance of the relationship" (Riffe et al., 2005, p. 191). Stepwise binary logistic regression is used to determine which of the predictor variables are statistically significant in multivariate models. Stepwise logistic regression models are appropriate where the study is purely exploratory and predictive (Menard, 2002). This is an exploratory study because little is known empirically about police sexual misconduct arrests and the specific factors responsible for conviction and/or

job loss subsequent to the arrest of a police officer for sex-related crimes. Summary statistics are also reported for evaluation of regression diagnostics and each logistic regression model.

Classification tree analysis—also known as decision trees—is utilized as a statistical technique to uncover the causal pathways between independent predictors and one of Stinson’s (2009) types of police crime versus other types of police crime, job loss, and conviction. This approach moves beyond the simple one-way additive relationship of linear statistical models by identifying the hierarchical interactions between the independent predictors and their compounding impact. Classification trees examine the entire data set and produce a graphical output that ranks the variables by statistical importance. The most influential variable is represented at the top of the tree (known as the root node). This variable is used to split the data in a recursive manner through the creation of subsets into the lower branches of the tree. Variable selection and splitting criteria are driven by the algorithm of the tree program. Decision tree techniques have received attention due to their ability to handle interaction effects in data without being bound to statistical assumptions (Sonquist, 1970). Classification tree analysis has been used to examine police practices including career-ending police misconduct (Kane & White, 2013), police drug corruption arrests (Stinson, Liederbach, et al., 2013), fatal and nonfatal incidents involving conductive energy devices (White & Ready, 2009), and police drunk driving (Stinson, Liederbach, Brewer, & Todak, 2014). This study utilizes two decision tree predictive analytic algorithms: Classification and Regression Trees (CART) and Chi-Square Additive Interaction Detection (CHAID).

CART is a classification procedure that produces a binary decision tree and restricts partitioning at each node to two nodes, thus producing binary splits for each child node (Densio, Mallick, & Smith, 1998). Breiman, Friedman, Olshen, and Stone’s (1984) CART

algorithm uses an extensive and exhaustive search of all possible univariate splits to determine the splitting of the data for the classification tree. Partitioning will continue until the algorithm is unable to produce mutually exclusive and homogenous groups (De'ath & Fabricius, 2000; Dension et al., 1998). After creating an exhaustive tree, CART will prune nodes that do not significantly contribute to overall prediction.

The CHAID algorithm differs from other classification tree algorithms through the inclusion of multiple measurement levels for the independent variables. The algorithm can compute nominal, ordinal, and interval levels for both independent and dependent variables. Therefore, the independent variables can have different levels of measurement. If a ratio level variable is included in the analysis, the program will convert the variable into a categorical variable. Kass (1980) was concerned with the computation time when running decision trees and therefore, created his algorithm with time in mind (Wilkinson, 1992). He created an algorithm that partitioned the data in a timely manner without losing its ability to uncover interactions and lose predictive power. Because of this, computation time is saved and CHAID can search through large data sets to produce T without adding significant computation time.

The CART algorithm was primarily used in this study because it fit our problems and produced optimal decision trees for most of the models by minimizing the generalization error (see, e.g., Rokach & Maimon, 2005, p. 167). CHAID was selected for a few decision tree models due to CART's inability to partition the data. Since CART only produces binary splits certain subsets of data are unable to be partitioned into an interpretable tree. The CHAID algorithm conducts exhaustive searches of the data, which allows smaller data sets to be partitioned into trees.

The predictive power of logistic regression and classification tree models is assessed through the area under the curve (AUC) component of the receiver operating characteristic (ROC). The AUC assesses the predictive accuracy of a statistical model and serves as the preferred method for assessing and comparing models (Bewick, Cheek, & Ball, 2004; Dolan & Doyle, 2000). The ROC curve considers the sensitivity versus 1- specificity, a representation of the true positive rate versus the false positive rate (TPR vs. FPR). The curve is displayed graphically by plotting the true positive rate (TFP) on the y-axis and the false positive rate (FPR) on the x-axis. ROC curves are interpreted through the AUC, a score that ranges from zero to one. A straight line through a ROC curve is the equivalent of 0.5 and suggests that the model is no better at prediction than flipping a coin. A score of one indicates that the model is able to accurately predict all cases. The AUC is interpreted as a proportional reduction of error (PRE) measure of explained variation by calculating $R_{ROC}^2 = 2(AUC - .5)$ (Menard, 2010).

Strengths and Limitations

The news search methodology utilizing the Google News search engine and the Google Alerts email update service provided an unparalleled amount of information on police crime arrests at law enforcement agencies across the United States. The Google News search engine algorithm offers some clear advantages over other aggregated news databases and the methodologies employed by previous studies that used news-based content analyses to document cases of sex-related police misconduct. The Google Alerts email update service provides the ability to run persistent automated queries of the Google News search engine and deliver real-time search results. The Google News search engine draws content from more than 50,000 news sources (Bharat, 2012) and allows for access to a larger number of police misconduct cases than would be available through other methods (Payne, 2013).

There are four primary limitations of the data. First, this research study includes every case known to the research team of a nonfederal sworn law enforcement officer who was arrested during the years 2005-2011. Thus, this study is a census of the universe of police crime arrest cases identified through our search methodology. We do not purport to include every single instance of a law enforcement officer being arrested. Second, our research is limited by the content and quality of information provided for each case. The amount of information available on each case varied, and data for several variables of interest were missing for some of the cases. This is especially true for victim-related variables in this study as news organizations generally do not report the names and other personally identifiable information (e.g., victim age, relationship to the accused) of rape victims (Denno, 1993). Third, the data are limited to cases that involved an official arrest based on probable cause for one or more crimes. We do not have any data on police officers who engaged in criminal activity if their conduct did not result in an arrest. Finally, we note that these data are the result of a filtering process that includes the exercise of discretion by media sources in terms of both the types of stories covered and the nature of the content devoted to particular stories (Carlson, 2007). Ready, White, and Fisher (2008), however, found that news coverage of officer misconduct is consistent with official police records of these events. Research also suggests that police agencies are not especially effective at controlling media accounts of officer misconduct (Chermak, McGarrell, & Gruenewald, 2006). Despite the noted limitations, the use of news articles as the primary data source is a long established method of analyzing deviant/illegal police behavior (see, e.g., Lawrence, 2000; Lersch & Feagin, 1996; Rabe-Hemp & Braithwaite, 2013; Ross, 2000).

Efforts were made to minimize the limitations inherent in utilizing open source information for data collection and quantitative analyses. Online news sources were limited to

the news articles published by reputable news sources. We did not rely on blog entries and other self-published information. Whenever possible data sources were triangulated for each instance where an arrest case of a sworn law enforcement officer was reported. Triangulation included reliance on multiple published news articles, videos from television news programs, and online criminal court records. Efforts were made to verify case information by at least two separate sources whenever possible.

As LaFree and Dugan (2007) noted, even with data triangulation there are two serious drawbacks in use of open source data culled from online news sources. First, news reporting on police crime is inherently biased toward publication of only the most newsworthy forms of crime by sworn law enforcement officers. In some instances arrests of officers were not reported in the news, because the arrestee's employment as a law enforcement officer was unknown to news reporters. Indeed, sometimes the only aspect making an arrest newsworthy is the fact that a law enforcement officer was arrested. Second, our database lacks information on many aspects of the crimes reported in online open source news publications. There is a lack of uniformity from article to article and across the census of articles collected about each case and arrest. There was journalistic consistency whereby news articles typically included some or all of the following data: name of the officer arrested, officer's employer, officer's age and years of service as a sworn law enforcement officer and types of criminal offense(s) charged. Often times the information regarding crime victims in these cases were vague, typically to protect the identity of victims of domestic violence or sexual assault, and when the victim was a child. News articles as a primary source of arrest data is merely a substitute for better data sources that either do not exist or are not readily available to researchers. There are no official data collected, tabulated,

archived, or published that would provide the same level of information as analyzed in this study.

RESULTS

The results of the study are organized in seven parts. Part I presents the full police crime data set models. Part II presents the sex-related police crime data set models. Part III presents the alcohol-related police crime data set models. Part IV presents the drug-related police crime data set models. Part V presents the violence-related police crime data set models. Part VI presents the profit-motivated police crime data set models. Part VII presents the employing law enforcement agencies in terms of rates of police crime per agency, per 1,000 officers, and per 100,000 population.

Part I: Full Police Crime Data Set Models

The Google News searches resulted in the identification of 6,724 cases in which sworn law enforcement officers were arrested during the time period January 1, 2005, through December 31, 2011. The cases involved the arrests of 5,545 individual sworn officers employed by 2,529 nonfederal state, local, and special (e.g., school district police, college/university police, park police, and constables) law enforcement agencies located in 1,205 counties and independent cities in all 50 states and the District of Columbia.² Of these, 674 (12.1%) of the officers have more than one case (although $\bar{X} = 1.21$, $Mdn = 1.00$, $Mode = 1$, $SD = .870$) because they have had more than one victim (one criminal case per victim) and/or were arrested on more than one occasion.

More than half of the criminal cases resulted in the arrested officer losing his or her job ($n = 3,628$, 54.0%) as a result of being arrested. The known final adverse employment outcomes include cases where no adverse action was taken against the arrested officer ($n = 868$, 12.9%), cases where the officer was suspended from their job ($n = 2,228$, 33.1%) as a sworn officer for a

² Cities in the Commonwealth of Virginia are not in counties. The cities of Baltimore, Maryland, St. Louis, Missouri, and Carson City, Nevada, are also independent cities that are separate from counties.

period of time, cases where the officer resigned ($n = 1,709$, 25.4%), and cases where the officer was terminated ($n = 1,919$, 28.5%). Less than half of the police crime arrest cases resulted in known criminal conviction ($n = 2,846$, 42.3%) on at least one offense charged against the arrested officer.

Arrested Officers, Employing Law Enforcement Agencies, and Criminal Offenses Charged

Table 1 presents information on the arrest cases in terms of the arrested officers and their employing nonfederal law enforcement agencies. Most of the cases involve male officers ($n = 6,357$, 94.5%). The modal category for known officer age at time of arrest is 36-39 years of age ($n = 1,081$, 16.1%). The youngest officer(s) were age 19 at time of arrest, and the oldest officer(s) were 79 years old (\bar{X} age = 37.34, *Mdn* age = 37, Mode age = 39, *SD* = 8.576 years). The modal category for known years of service at time of arrest is three to five years ($n = 954$, 14.2%). Most of the cases involve police employed in a patrol or other street-level rank such as nonsupervisory officers, deputies, troopers, and detectives ($n = 5,464$, 81.3%). Other arrest cases involve line and field supervisors ($n = 881$, 13.1%) (i.e., corporals, sergeants, and lieutenants), as well as police managers and executives ($n = 379$, 5.6%) (i.e., captains, majors, colonels, deputy chiefs and chief deputies, and chiefs and sheriffs). More than half of the arrest cases involve crimes that were committed while an officer was on-duty ($n = 3,931$, 58.5%). Two-thirds of the cases ($n = 4,447$, 66.1%) involve arrests made of officers by a law enforcement agency other than the arrested officer's employing law enforcement agency.

Most of the arrest cases involve sworn officers employed by municipal police departments ($n = 4,915$, 73.1%) or sheriff's offices ($n = 1,109$, 16.5%). Arrested officers were also employed by primary state police agencies ($n = 269$, 4.0%), county police departments ($n = 226$, 3.4%), special police departments ($n = 174$, 2.6%) (e.g., park police departments, school

district police departments, college/university police departments, etc.), or other nonfederal law enforcement agencies ($n = 31$, 0.4%) (e.g., constable agencies, tribal police departments, and regional police departments). The modal category for agency size by number of officers employed is 1,000 or more full-time sworn officers ($n = 1,857$, 27.6%) and zero part-time sworn officers ($n = 5,008$, 74.5%). Most of the arrested officers were employed by a law enforcement agency located in a nonrural metropolitan county ($n = 5,711$, 84.9%). The employing agencies are located throughout the United States, including in Southern states ($n = 2,906$, 43.2%), Northeastern states ($n = 1,430$, 21.3%), Midwestern states ($n = 1,380$, 20.5%), and Western states ($n = 1,008$, 15.05%).

Table 2 presents the cases in terms of the most serious offense charged. There are 61 separate offense categories represented as the most serious offense charged in the arrest cases in years 2005-2011. Most common as the most serious offense charged in a case are simple (misdemeanor) assault ($n = 877$, 13.0%), driving under the influence ($n = 841$, 12.5%), aggravated (felonious) assault ($n = 572$, 8.5%), forcible fondling ($n = 352$, 5.2%), forcible rape ($n = 322$, 4.8%), and drug offenses ($n = 308$, 4.6%). Other noteworthy crimes that were the most serious offense charged in cases include murder and nonnegligent manslaughter ($n = 125$, 1.9%), burglary ($n = 112$, 1.7%), robbery ($n = 109$, 1.6%), thefts from buildings ($n = 103$, 1.5%), statutory rape ($n = 100$, 1.5%), extortion and blackmail ($n = 95$, 1.4%), forcible sodomy ($n = 94$, 1.4%), obstruction of justice ($n = 93$, 1.4%), pornography and obscene material ($n = 86$, 1.3%), and criminal deprivation of civil rights ($n = 84$, 1.2%).

Victims of Police Crime

Table 3 presents information on the characteristics of the victims in police crime arrest cases in years 2005-2011. Over half of the known victims of police crime are female ($n = 2,246$,

33.4%, valid 61.2%). The modal category for victim age is 25-32 years old (although \bar{X} age = 24.16, Mdn age = 20, Mode age = 15, SD = 14.134 years). Victim age is missing data in a large number of cases ($n = 4,876$, 72.5%). In many cases ($n = 2,142$, 31.9%) we were able to determine if the victim was an adult ($n = 3,051$, 45.3%, valid 76.5%) or a child ($n = 939$, 14.0%, valid 23.5%) but were unable to determine the exact age of a victim. The youngest victims were infants under the age of one year old ($n = 10$, 0.1%, valid 0.5%) and the oldest victims were age 92 ($n = 4$, 0.1%, valid 0.2%).

The relationship of the victim and the arrested officer could not be determined in a large number of arrest cases ($n = 2,790$, 41.5%). Many of the known victims are adult strangers or nonstranger acquaintances ($n = 2,237$, 33.3%, valid 56.9%) or a child unrelated ($n = 673$, 10.0%, valid 17.1%) to the arrested officer. Other victims are a current spouse ($n = 346$, 5.1%, valid 8.8%), former spouse ($n = 68$, 1.0%, valid 1.7%), a current girlfriend or boyfriend ($n = 202$, 3.0%, valid 5.1%), a former girlfriend or boyfriend ($n = 136$, 2.0%, valid 3.5%), or a child or stepchild of the arrested officer ($n = 177$, 2.7%, valid 4.5%). The victims in some of the arrest cases are also police officers ($n = 229$, 3.4%, valid 5.8%). In those cases where the victim was also a police officer, most of the crimes occurred while the officer who was arrested was off-duty ($n = 179$, 78.2%), where $\chi^2(1, N = 3,967) = 30.746, p < .001, V = .088$.

Predicting Conviction

Bivariate analyses were conducted as part of the regression diagnostics and to assess the associations between various independent variables and the dependent predictor variables of interest. Chi-Square associations are statistically significant at the $p < .05$ level for 90 independent variables, individually, and the dependent variable, *criminal conviction on any offense charged*. See Table 4. The strongest bivariate predictors of an officer being convicted

on any offense charged are (a) most serious offense charged, where $\chi^2(67, N = 3,934) = 394.757$, $p < .001$, $V = .317$; (b) age of the victim, where $\chi^2(1, N = 3,934) = 110.509$, $p = .005$, $V = .305$; and (c) victim's relationship to the arrested officer, where $\chi^2(1, N = 3,934) = 114.234$, $p < .001$, $V = .219$.

Multivariate analyses were conducted to further investigate the relationship between the outcome variable, criminal conviction on any offense charged, and various predictor variables. Table 5 presents a backward stepwise binary logistic regression model predicting criminal conviction on any offense charged. Bivariate correlations computed for each of the independent variables revealed that none of the variables were highly correlated with each other. Multicollinearity is not a problem in the model as indicated by no tolerance statistics below .575 and no variance inflation factors exceeding 1.386. A Durbin-Watson score of 1.754 indicates that there is no autocorrelation in the model. Regression results indicate that the overall model of 16 predictors is statistically reliable in distinguishing between officers who were convicted on any offense charged and officers who were not convicted on any charge. The model correctly classified 71.2% of the cases (AUC = .718, 95% CI [.697, .740], $R^2_{ROC} = .436$). Wald statistics indicate that all of the independent variables in the model significantly predict conviction versus nonconviction.

Odds ratio interpretations provide context for prediction of criminal case outcomes. Twelve independent variables in this model predict when an officer is more likely to be convicted of a crime. For example, the simple odds of an officer being convicted on any offense charged are 13 times greater if the arrest case involved a drug shakedown, controlling for all other variables in the model. The simple odds of an officer being convicted are 6.9 times greater if the arrest case was officer-involved domestic violence and the victim died of the injuries,

controlling for all other variables in the model. Also, the simple odds of an officer being convicted are about 1.9 times greater if the officer was arrested for driving under the influence while driving a personally-owned vehicle, controlling for all other variables. Four independent variables in the model predict when an officer is less likely to be convicted of any offense charged in their arrest case. Among these, for every one step increase in an arrested officer's rank at time of their arrest, the simple odds of conviction go down by 9.2%, controlling for all other variables in the model. The simple odds of conviction go down by 29% if an officer was suspended from his or her law enforcement job following their being arrested. Also, the simple odds that an arrested officer will be convicted go down by 38.8% if the officer was arrested for a crime related to officer-involved domestic violence and the victim suffered nonfatal injuries.

Decision trees were used to derive the casual pathways between independent predictors and the case dispositions using the CART algorithm. The CART analysis includes a total of 3,934 cases. Figure 1 presents the results of this analysis. The tree had an overall classification score of 74.6% (AUC = .694, 95% CI [.676, .713], $R_{ROC}^2 = .388$) and selected the variable *most serious offense charged* as the splitting criterion. Officers who were charged with offenses scores over 18 were convicted of a crime in 77.8% of the cases (node 2). In contrast, officers who were charged with offenses scores equal to or less than 18 were convicted in 53.9% of the cases (node 1). The second tier of the decision tree includes four additional splits in the data. Node 2 is further separated by the variable *most serious offense charged*; these scores are all greater than 18. Officers who received an offense score between 19 and 68 were convicted of a crime in 80.4% of the cases. Officers who had a score above 68 were only convicted in 63.7% of the cases.³

³ The numerical scoring for this variable (V183, most serious offense charged) is misleading to the extent that the categorical variable was created by taking the 65 dichotomous offense variables (V15 through V80) and making a

Node 1 was further separated by the variable *victim's relationship to the offender*. In the cases where victims were a stranger or an unrelated child the officers were convicted in 60.3% of the cases. In cases that involved victims who were a current spouse to the offender, relative, child or stepchild, current and or former boyfriend/girlfriend, the officers were convicted in 43.4% of the cases. The tree also included the following variables in tiers three through five: gender of the victim, geographic division, victim's relationship to the offender, state, profit-motivated versus other crime type, and age categorical.

Predicting Job Loss

The next set of models predict job loss after an officer has been arrested for committing one or more crimes. At the bivariate level, Chi-Square associations are statistically significant at the $p < .05$ level for 120 independent variables, individually, and the dependent variable *job loss*. See Table 6. The job loss variable is a binary variable that was created by recoding the variables for involuntary termination (V100)—that is, an officer was fired—and resignation (V101)—that is, an officer quit his or her job as a sworn officer—after being arrested. The recoded dichotomous variable for job loss is coded as 0 = *kept job*, and 1 = *lost job*. Cases where we were unable to determine the final adverse employment outcome were coded as 0 = *kept job*. As such, for this dichotomous recoded variable the absence of information as to an officer having lost their job was treated as if the officer kept their job after being arrested for some criminal offense(s).⁴ The strongest bivariate predictors of an officer losing their job as a sworn law

new 65-category variable for the most serious offense charged in each case. Since the research assistant coders were already familiar with the specific offenses (that is, V15-V80), we continued to use the labels of 15-80 for the 65 offense categories in V183.

⁴ The research interest with this variable is in sworn law enforcement officers who lost their jobs (either through involuntary termination or voluntary resignation). A coding protocol decision was made to focus on what our data would support, which is job loss. We operationalize kept job as those cases where the arrested officer is not known by us to have lost their job. Data collection efforts on this variable often resulted in missing data from the open source information because in many jurisdictions final adverse employment outcomes are treated as confidential personnel records.

enforcement officer following a criminal arrest are (a) most serious offense charged, where $\chi^2(1, N = 6724) = 752.849, p < .001, V = .335$; (b) age of victim, where $\chi^2(1, N = 6,724) = 111.533, p = .008, V = .247$; and (c) victim's relationship to the arrested officer, where $\chi^2(1, N = 6,724) = 173.685, p < .001, V = .210$.

Table 7 presents a backward stepwise binary logistic regression model predicting job loss. Bivariate correlations computed for each of the independent variables revealed that none of the variables in the model were highly correlated with each other. Multicollinearity is not a problem as indicated by no tolerance statistics below .592 and no variance inflation factors higher than 1.689. There is no autocorrelation in the model as measured by the Durbin-Watson score of 1.646. Logistic regression results indicate that the multivariate model of 11 predictors is statistically reliable in distinguishing between officers who kept their jobs after being arrested and officers who lost their jobs after being arrested, although the model only correctly classified 68.7% of the cases (AUC = .638, 95% CI [.625, .652], $R^2_{ROC} = .276$). Wald statistics indicate that all of the independent variables in the model significantly predict whether an officer lost their or kept their job subsequent to being arrested.

Predictors of the final adverse employment outcomes are aided by interpretation of the odds ratios. Seven of the independent variables in the model predict when an officer is more likely to lose their job after being arrested. The simple odds that an officer will lose their job (through either involuntary termination or voluntary resignation) are approximately 2.5 times greater if the arrested officer has been sued in federal court pursuant to 42 U.S.C. §1983 (deprivation of rights under color of law) at some point during his or her law enforcement career. The federal civil rights civil action(s) may or may not be related to the underlying incident(s) leading to an officer's criminal arrest, and the federal lawsuit(s) may have been filed before

and/or after an officer's date of arrest. The type of crime(s) for which an officer was arrested impacts on job loss. For example, the simple odds that an officer will lose their job are 1.3 times greater if the offense was a sex-related crime. Similarly, the simple odds that an officer will lose their job increase by 73% if the crime involved police sexual violence. Likewise, the simple odds that an officer will lose their job increase by about 54% if the arrest case is alcohol-related.

Four of the independent variables in the logistic regression model predict when an officer is more likely to keep their job in the aftermath of being arrested. Adverse employment outcomes short of termination predict the final adverse employment outcome. If an officer was suspended from their job after being arrested, then the simple odds of losing their job go down by 61.5%. Likewise, the simple odds of an officer losing their job after being arrested decrease by 65.4% if the officer was reassigned to another position within the employing law enforcement agency after being arrested. Two variables related to the nature of the incident resulting in an officer's arrest also predict that an officer will not ultimately lose their job as a sworn law enforcement officer as a result of being arrested. The simple odds that an officer will lose their job decrease by 48.8% if the crime involves family violence. As to drug offenses, the simple odds that an officer will lose their job decrease by 95.6% if the criminal case involves marijuana.

Figure 2 presents the results of predicting job loss and included a total of 6,724 arrest cases. The tree had an overall classification score of 71.0% (AUC = .766, 95% CI [.754, .777], $R^2_{ROC} = .532$) and selected the variable *sex-related police crime versus other police crime* as the splitting criterion. Officers who were involved in sex-related cases (node 1) lost their job in 72.1% of the cases. In contrast, officers who were involved in a criminal case that was not sex-related (node 2) lost their job in 48.9% of the cases.

The sex-related cases in node 1 were partitioned by the variable *officer was suspended for a period of time*. Officers who had been previously suspended lost their job in 66.3% of the cases and officers who were not previously suspended lost their job in 82.1% of the cases. The cases that were not sex-related in node 2 were partitioned by the variable *profit-motivated police crime versus other crime*. Officers who were involved in a profit-motivated case lost their job in 67.7% of the cases and officers who were not involved in a profit-motivated case lost their job in 40.9% of cases. The tree also included the following variables in tiers three through nine: internal versus organization, geographic division, state, official capacity versus individual capacity, age categorical, victim's relationship to the offender, driving under the influence, urban/rural continuum, years of service categorical, part-time sworn personnel, drug-related police crime versus other crime, officer was reassigned to another position in the agency, age of the victim, full-time sworn personnel, and gender of the victim.

Predicting Sex-related Police Crime

In this section, models predict sex-related arrest cases versus other types of arrest cases. Preliminarily, at the bivariate level, Chi-Square associations are statistically significant at the $p < .05$ level for 117 independent variables and the dependent variable, *sex-related arrest cases versus other types of crimes*. See Table 8. The strongest bivariate predictor of sex-related police crime is the most serious offense charged, where $\chi^2(63, N = 6,724) = 5322.861, p < .001, V = .890$, indicating that there is a very high correlation between outcome variable (sex-related police crime arrest cases, which is a true dichotomy) and the predictor variable (most serious offense charged, which is a categorical variable with up to 65 levels of offenses). The most serious offense charged variable was coded based on the hierarchy of offenses in the Uniform Crime Reports. The very high bivariate correlation here is because the second most serious offense on

the UCR hierarchy is rape, and rape is the most serious offense charged ($n = 322$, 21.8%) within the sex-related arrest cases ($N = 1475$). Other strong bivariate associations of sex-related police crime arrest cases include (a) age of the victim, where $\chi^2 (79, N = 1,848) = 592.004, p < .001, V = .566$; (b) relationship of the victim to the arrested officer, where $\chi^2 (7, N = 3,934) = 909.238, p < .001, V = .481$; (c) years of difference in age between the arrested officer and their victim, where $\chi^2 (103, N = 6,724) = 1,406.902, p < .001, V = .457$; (d) gender of the victim, where $\chi^2 (1, N = 3,668) = 651.711, p < .001, V = .422$; and (e) child victims, where $\chi^2 (1, N = 3,990) = 684.979, p < .001, V = .414$.

Moderate bivariate associations of sex-related arrest cases include (a) driving while female encounters, where $\chi^2 (1, N = 6,724) = 587.698, p < .001, V = .296$; (b) citizen complaint as the method of crime detection, where $\chi^2 (1, N = 6,724) = 520.439, p < .001, V = .278$; (c) profit-motivated police crime, where $\chi^2 (1, N = 6,724) = 492.036, p < .001, V = .271$; (d) violence-related police crime, where $\chi^2 (1, N = 6,724) = 357.899, p < .001, V = .231$; and (e) alcohol-related police crime, where $\chi^2 (1, N = 6,724) = 260.078, p < .001, V = .197$.

A backward stepwise binary logistic regression model predicting sex-related police crime arrest cases versus other types of police crime arrest cases is presented in Table 9. Bivariate correlations computed for each of the independent variables in the model revealed that none of the variables were highly correlated with each other. Multicollinearity is not a problem as indicated by no tolerance statistics below .312 and no variance inflation factors higher than 3.207. The Durbin-Watson score of 1.643 indicates that there is no autocorrelation in the model. Regression results indicate that the overall model of 14 predictors is statistically reliable in distinguishing between sex-related police crime arrest cases and police crime arrest cases involving other types of crime. The model correctly classified 88.7% of the cases ($AUC = .939$,

95% CI [.931, .947], $R^2_{ROC} = .878$). Wald statistics indicate that all of the independent variables in the regression model significantly predict sex-related police crime arrest cases.

Interpretation of odds ratios provides context for prediction of sex-related police crime arrest cases. Five of the independent variables in the model predict sex-related police crime arrest cases versus other types of police crime arrest cases, four of which are interpreted in the sentences that follow. Duty status predicts sex-related police crime. The simple odds that an arrested officer's case involves a sex-related offense increase by 57% if the officer was on-duty at the time of commission of the crime(s) charged. The method of crime detection also predicts sex-related arrest cases. The simple odds that an officer's arrest is sex-related are approximately 6.2 times greater if the method of crime detection is a citizen complaint, controlling for all other variables in the model. Since sex crimes are typically committed out of public view it makes sense that the primary method of crime detection for sex crimes is by way of a citizen complaint as opposed to other methods of crime detection.

Two predictors involve characteristics of the victim of an officer's sex-related arrest case. The simple odds that the victim is a child are 5.6 times greater if the arrest case is sex-related versus some other type of crime. The relationship of the victim to the arrested officer also predicts sex-related police crime arrest cases versus other types of police crime arrest cases. Victim relationship is an eight category variable, and the precise interpretation is difficult in a logistic regression model. Literally, the simple odds that an officer's arrest case is sex-related go up by 40.7% for every one unit increase in victim relationship (but this is a nominal-level measure and the practical interpretation is lacking). In other words, the likelihood of a police crime arrest case being sex-related increases as you move from the victim being a spouse, through other levels of relation, toward victims who are strangers or nonstranger acquaintances.

Ten of the independent variables in the logistic regression model predict that a police crime arrest case will be some type of crime other than a sex-related one. For example, the simple odds that an arrest case is sex-related decrease by 96.9% if the victim is male. Family violence cases are typically not also sex-related crimes. The simple odds that a crime is sex-related decrease by 73.3% if the crime involves family violence. Also, the simple odds that a crime is sex-related decrease by 77% if the arrest case is officer-involved domestic violence where the officer is accused of using his hands/fists as a weapon. Alcohol-related or profit-motivated police crime arrest cases are not typically also sex-related crimes. The simple odds that an arrest case is sex-related decrease by 75.4% if the case is alcohol-related, whereas the simple odds that an arrest case is sex-related decrease by 88.6% if the case is profit-motivated. Finally, the simple odds of an arrest case being sex-related decrease by 51.5% if the arrested officer has been sued in federal court pursuant to 42 U.S.C. §1983 at some point during his or her law enforcement career.

Figure 3 presents the results of predicting sex-related cases versus other crime types and included a total of 6,724 arrest cases. The tree had an overall classification score of 89.6% (AUC = .895, 95% CI [.884, .907], $R_{ROC}^2 = .790$) and selected the variable *victim age* (*categorical*) as the splitting criterion. Cases that involved the victims from the age of birth to 19 (node 1) were sex-related 68.4% of the time and cases that involved victims 20 years or older (node 2) were sex-related in only 14.7 % of the cases.

The victim age categories in node 1 were partitioned by the variable *gender of the victim*. Cases that involved a female victim were sex-related 84.2% of the time and cases that involved male victims were sex-related in only 34.1% of the cases. The victim age categories in node 2 were partitioned by the variable *driving while female encounter*. Cases that stemmed from

driving while a female encounter were sex-related 95.7% of the time and cases that did not involve a female encounter were only sex-related in 12.3% of the cases. The tree also included the following variables in tiers three through five: victim's relationship to the offender and alcohol-related versus not alcohol-related.

Predicting Alcohol-related Police Crime

The next set of models predict alcohol-related police crime arrest cases versus other types of police crime arrest cases. Table 10 presents statistically significant Chi-Square bivariate associations at the $p < .05$ level for 116 independent variables and the dependent variable, *alcohol-related arrest cases versus other types of arrest cases*. The strongest bivariate predictor of alcohol-related police crime arrests is the most serious offense charged, where $\chi^2(63, N = 6,724) = 3906.421, p < .001, V = .762$. This very strong bivariate association is likely due to alcohol-related incidents typically falling within relatively few offense categories (e.g., driving under the influence, public drunkenness, disorderly conduct, etc.) for a large number of the alcohol-related arrest cases. Other moderate bivariate associations of alcohol-related police crime arrest cases include (a) duty status, where $\chi^2(1, N = 6724) = 630.074, p < .001, V = .306$; (b) victim age, where $\chi^2(79, N = 1,848) = 172.884, p < .001, V = .306$; and (c) individual versus official capacity, where $\chi^2(1, N = 6,724) = 619.269, p < .001, V = .303$.

Table 11 presents a backward stepwise binary logistic regression model predicting alcohol-related police crime arrest cases. Bivariate correlations computed for each of the independent variables in the model revealed that none of the variables were highly correlated with each other. Multicollinearity is not a problem as indicated by no tolerance statistics below .392 and no variance inflation factors higher than 2.552. The Durbin-Watson score of 1.612 indicates that there is no autocorrelation in the model. Logistic regression results indicate that

the overall model of 17 predictors is statistically reliable in distinguishing between alcohol-related police crime arrest cases and police crime arrest cases involving other types of police crime. The model correctly classified 88.1% of the cases (AUC = .802, 95% CI [.781, .823], $R^2_{ROC} = .604$).

Odds ratio interpretations provide context for prediction of alcohol-related police crime arrest cases. Seven of the independent variables in the model predict when an arrest case is more likely to be alcohol-related. Two of these predictors are independent variables relating to the underlying nature of the criminal behavior. The first relates to drug usage. The simple odds that an officer's arrest case will be alcohol-related are 5 times greater if the arrest incident involves marijuana. This can be explained to the extent that imbibing in alcoholic beverages and smoking marijuana often co-occur in social settings. The second relates to sexual violence. The simple odds that an officer's arrest case will be alcohol-related are 1.6 times greater if the incident also involves police sexual violence. This specific finding is counterintuitive for two reasons. First, police sexual violence invokes some aspect of an officer's official status as a sworn law enforcement officer and most of the police sexual violence arrest cases involved on-duty ($n = 516, 82.8\%$) criminal behavior, where $\chi^2(1, N = 6,724) = 481.979, p < .001, V = .268$. Second, most of the alcohol-related arrests in this study occur off-duty ($n = 1,235, 87.9\%$). Events occurring in the aftermath of an officer's commission of criminal offense(s) also predict alcohol-related police crime. The simple odds that an officer's arrest case will be alcohol-related are approximately 1.2 times greater if there an ensuing scandal or cover up of the incident at the law enforcement agency employing the arrested officer.

Ten of the independent variables in the logistic regression model predict when it is unlikely that an officer's arrest case will be alcohol-related. Alcohol-related crimes by police

officers tend to occur off-duty. The simple odds that an officer's arrest case will be alcohol-related decrease by 91.9% if the officer was on-duty when the crime occurred. Interestingly, although acts of police sexual violence predict alcohol-related crime arrests, that is not the case for other types of sex-related crime or violence-related crime. The simple odds that an officer's arrest case will be alcohol-related decrease by 74.3% if the crime is sex-related. Similarly, the simple odds that an officer's arrest case will be alcohol-related decrease by 29.7% if the crime is violence-related. Finally, crimes by police officers involving child victims are typically not alcohol-related offenses. The simple odds of an officer's arrest case being alcohol-related go down by 73.4% if the victim of the crime is a child.

Figure 4 presents the results of predicting alcohol-related cases versus other crime types and included a total of 6,724 cases. The tree had an overall classification score of 89.3% (AUC = .901, 95% CI [.893, .910], $R^2_{ROC} = .802$) and selected the variable *internal crime versus organizational crime* as the splitting criterion. Cases that involved a crime by the organization against the officer (node 1) were alcohol-related 98.6% of the time and cases that internal crimes against the organization (node 2) were alcohol-related in only 18.3 % of the cases.

A crime by the organization against the officer (node1) was a terminal node and was unable to be partitioned further. Crimes by the officer against the organization in node 2 were partitioned by the variable *duty status*. Cases that involved off-duty officers at the time of the offense were alcohol-related 26.7% of the time and cases that involved on-duty officers were alcohol-related in only 6% of the cases. The tree also included the following variables in tiers three through ten: age of victim, profit-motivated versus not profit-motivated, violence-related versus other crime type, official misconduct / official oppression / violation of oath, sex-related

versus other crime type, internal versus organizational, drug-related versus other crime type, false report / false statement, and method of crime detection: citizen complaint.

Predicting Drug-related Police Crime

The models in this section predict drug-related police crime arrests versus other types of police crime arrest cases. Table 12 presents statistically significant Chi-Square bivariate associations at the $p < .05$ level for 88 independent variables and the dependent variable, *drug-related arrest cases versus other types of arrest cases*. Here again, the strongest bivariate predictor of drug-related police crime arrests is the variable most serious offense charged, where $\chi^2 (63, N = 6,724) = 3127.330, p < .001, V = .682$. Many, but not all, of the drug-related cases include specific drug offenses (coded as V23 in this data set), which explains this very strong bivariate correlation. Other moderate bivariate associations of drug-related police crime arrest cases include (a) profit-motivated police crime, where $\chi^2 (1, N = 6,724) = 580.101, p < .001, V = .294$; (b) violence-related police crime, where $\chi^2 (1, N = 6,724) = 331.322, p < .001, V = .222$; (c) age of the victim, where $\chi^2 (79, N = 1,848) = 140.050, p < .001, V = .275$; and (d) officer-involved domestic violence resulting in fatal injuries to a victim, where $\chi^2 (1, N = 3,840) = 3.840, p = .050, V = .240$.

Table 13 presents a backward stepwise binary logistic regression model predicting drug-related police crime arrest cases. Bivariate correlations computed for each of the independent variables in the model revealed that none of the variables were highly correlated with each other. Multicollinearity is not a problem in this model as indicated by no tolerance statistics below .662 and no variance inflation factors higher than 1.512. The Durbin-Watson score of 1.654 indicates that there is no autocorrelation in the model. Logistic regression results indicate that the overall model of ten predictors is statistically reliable in distinguishing between drug-related police

crime arrest cases and police crime arrest cases involving other types of police crime. The model correctly classified 97.9% of the cases (AUC = .645, 95% CI [.622, .668], $R_{ROC}^2 = .290$).

Odd ratio interpretations provide context for prediction of drug-related police crime arrest cases. Nine of the independent variables in the logistic regression model predict when an arrest case is more likely to be drug-related. Three other types of police crime also predict drug-related police crime arrests. The simple odds that an arrest case will be drug-related are 36.7 times greater if the crime is also profit-motivated. This finding suggests that much of the drug-related police crime involves the drug trade. Some drug-related police crime, however, is not related to the drug trade. For example, the simple odds that an arrest case will be drug-related are 3.6 times greater if the crime is also alcohol-related. Likewise, the simple odds that an officer's arrest case will be drug-related is about 3 times greater if the crime is also sex-related. Several of the predictors of drug-related police crime are specific criminal offenses. The simple odds that an arrest case will be drug-related are 15.7 times greater if the officer is charged with perjury, false reports, or false statements. Similarly, the simple odds that an officer's arrest case will be drug-related are 12.3 times greater if the officer is charged with obstruction of justice. Two specific sex-related criminal offenses also predict drug-related police crime. The simple odds of an officer's arrest case being drug-related are 9.4 times greater if the officer is charged with pornography or obscene materials. Also, the simple odds that an arrest case will be drug-related is 2 times greater if the officer is charged with forcible rape. One other predictor is noteworthy in that the simple odds of an officer's arrest case being drug-related are 3.7 times greater if an arrested officer's arrest case involves a DUI-related traffic accident.

Figure 5 presents the results of predicting drug-related cases versus other crime types and included a total of 6,724 cases. The tree had an overall classification score of 89.6% (AUC =

.862, 95% CI [.849, .876], $R^2_{ROC} = .724$) and selected the variable *profit-motivated versus other types of police crime* as the splitting criterion. Cases that were profit-motivated (node 1) were drug-related 27.5% of the time and cases that were not profit-motivated (node 2) were drug-related in only 5.9 % of the cases.

The not profit-motivated cases (node 1) were partitioned by the variable *violence-related police crime versus other crime*. Cases that were not violence-related were drug-related 12.8% of the time and cases that were violence-related were drug-related in only 1.5% of the cases. The profit-motivated cases (node 2) were partitioned by the variable *weapons law violation*. Cases that involved officers who had a weapons law violation were drug-related 55.5% of the time and cases that did not involve a weapons law violation were drug-related in only 24.9% of the cases. The tree also included the following variables in tiers three through six: age of victim, sex-related versus other crime type, method of crime detection: citizen complaint, state, and gender of victim.

Predicting Violence-related Police Crime

The models in this section predict violence-related police crime arrest cases versus other types of police crime arrest cases. Bivariate Chi-Square associations are statistically significant at the $p < .05$ level for 131 independent variables and the dependent variable, *violence-related arrest cases versus other types of arrest cases*. See Table 14. As in previous prediction models, the strongest bivariate predictor of violence-related police crime is the most serious offense charged, where $\chi^2(63, N = 6,724) = 4883.929, p < .001, V = .852$. This indicates a very high correlation between the outcome variable, violence-related arrest cases, and the predictor variable, most serious offense charged. A large number of the violence-related arrest cases involve a relatively small number of offense categories for the most serious offense charged

variable (e.g., aggravated assault, simple assault, murder and nonnegligent manslaughter, forcible rape, etc.). Strong bivariate associations of violence-related police crime arrest cases include citizen complaint as the method of crime detection, where $\chi^2(1, N = 6,724) = 1327.054$, $p < .001$, $V = .444$. Moderate associations of violence-related arrest cases include (a) years difference in victim age, where $\chi^2(103, N = 6,724) = 879.176$, $p < .001$, $V = .362$; (b) age of the victim, where $\chi^2(79, N = 1,848) = 166.314$, $p < .001$, $V = .300$; and (c) victim relationship to the arrested officer, where $\chi^2(7, N = 3,934) = 206.633$, $p < .001$, $V = .229$.

A backward stepwise binary logistic regression model predicting violence-related police crime arrest cases versus other types of police crime arrest cases is presented in Table 15. Bivariate correlations computed for each of the independent variables in the model revealed that none of the variables were highly correlated with each other. Multicollinearity is not a problem as indicated by no tolerance statistics below .471 and no variance inflation factors higher than 2.123. Autocorrelation is also not a problem in the model as indicated by the Durbin-Watson score of 1.608. Logistic regression results indicate that the overall model of 11 predictors is statistically reliable in distinguishing between violence-related police crime arrest cases and other types of police crime arrest cases. The model correctly classified 83.4% of the cases (AUC = .844, 95% CI [.826, .862], $R_{ROC}^2 = .688$). Wald statistics indicate that all of the independent variables in the logistic regression model significantly predict violence-related police crime arrest cases.

Odds ratio interpretations provide context for prediction of violence-related police crime arrest cases. Five of the independent variables in the logistic regression model predict when a police crime arrest case is more likely to be violence-related. Six of the independent variables predict when a police crime arrest case is less likely to be violence-related. Some interesting

patterns emerge. For example, the simple odds that an officer's arrest case will be violence-related increase by 5.8% for every one year increase in the officer's age at time of arrest. On the other hand, the simple odds that an officer's arrest case will be violence-related decrease by 3.9% for every one year increase in years of service as a sworn officer at time of arrest. Although at first glance this seems counterintuitive, it is easily at least partially explained by noting that not all police officers start their law enforcement careers at the same age. Many violence-related instances of police crime come to the attention of law enforcement authorities through citizens. The simple odds of an officer's arrest case being violence-related are almost 1.3 times greater if the method of crime detection is a citizen complaint. Most violence-related police crime is not also profit-motivated, as the simple odds that an officer's arrest case will be violence-related go down by 98.2% if the crime is also profit-motivated.

Figure 6 presents the results of predicting violence-related cases versus other crime types and included a total of 6,724 cases. The tree had an overall classification score of 84.6% (AUC = .882, 95% CI [.874, .891], $R^2_{ROC} = .764$) and selected the variable *citizen complaint as the method of crime detection* as the splitting criterion. Cases that involved a citizen complaint (node 1) were violence-related 68.1% of the time and cases that did not involve a citizen complaint were only violence-related in 22.9% of the cases.

Cases that involved citizen complaints in node 1 were partitioned by the variable *profit-motivated police crime versus other types of crime*. Cases that were profit-motivated were violence-related 16.9% of the time and cases that were not profit-motivated were violence-related in 76.8% of the cases. Cases that did not involve a citizen complaint in node 2 were partitioned by the variable *victim age (categorical)*. Cases that involved crimes from 12-15 years of age were violence-related in 15.8 of the cases and for age birth to 11 and 16 or older

were violence-related in 74% of the cases. The tree also included the following variables in tiers three through five: driving under the influence, drug-related crime versus other crime type, intimidation, and victim's relationship to the offender.

Predicting Profit-motivated Police Crime

In this section, models predict profit-motivated police crime versus other types of police crime arrest cases. Table 16 presents statistically significant Chi-Square bivariate associations at the $p < .05$ level for 127 independent variables and the dependent variable, *profit-motivated police crime arrest cases versus other types of arrest cases*. As in the other models using the full data set in this study, there is a very strong correlation between the variable most serious offense charged and the dependent variable. At the bivariate level for the association between the most serious offense charged and profit-motivated arrest cases, $\chi^2(1, N = 6,724) = 4449.343, p < .001, V = .813$. Other strong to moderate bivariate associations of profit-motivated police crime include (a) duty status, where $\chi^2(1, N = 6,724) = 633.147, p < .001, V = .307$; (b) age of the victim, where $\chi^2(79, N = 1,848) = 211.386, p < .001, V = .338$; (c) violence-related police crime, where $\chi^2(1, N = 6,724) = 1280.268, p < .001, V = .436$; (d) drug-related police crime, where $\chi^2(1, N = 6,724) = 580.101, p < .001, V = .294$; (e) alcohol-related police crime, where $\chi^2(1, N = 6,724) = 498.804, p < .001, V = .272$; (f) official capacity, where $\chi^2(1, N = 6,724) = 540.962, p < .001, V = .284$; and (g) sex-related police crime, where $\chi^2(1, N = 6,724) = 492.371, p < .001, V = .271$.

Table 17 presents a backward stepwise binary logistic regression model predicting profit-motivated police crime arrest cases. Bivariate correlations computed for each of the independent variables in the model revealed that none of the variables were highly correlated with each other. Multicollinearity is not a problem as indicated by no tolerance statistics below .362 and no

variance inflation factors higher than 2.790. The Durbin-Watson score of 1.776 indicates that there is no autocorrelation in the model. Logistic regression results indicate that the overall model of ten predictors is statistically reliable in distinguishing between profit-motivated police crime arrest cases and police crime arrest cases involving other types of crime. The model correctly classified 97.6% of the cases (AUC = .870, 95% CI [.801, .939], $R_{ROC}^2 = .740$).

Prediction of profit-motivated police crime arrest cases are explained through interpretation of odds ratios. Five of the independent variables in the model predict when an officer's arrest is more likely to be profit-motivated police crime versus other types of police arrest cases. The simple odds of a case being profit-motivated are 4.9 times greater if the crime came to the attention of law enforcement by a citizen complaint. These are not the types of crimes found on patrol by the police. More often than not profit-motivated police crime is crime that occurs while on-duty. The simple odds that an arrest case will be profit-motivated are 1.5 times greater if the crime occurred while on-duty. Profit-motivated police crime predicts when an arrested officer is at risk of being sued in his or her official capacity for civil rights violations. Specifically, the simple odds that an arrest case will be profit-motivated are 4.2 times greater if at some point during an officer's law enforcement career he or she was named as a party-defendant in a federal court civil action pursuant to 42 U.S.C. §1985 for a conspiracy to interfere with civil rights. Children are rarely the victim of profit-motivated police crime as the simple odds go up by 7.9% for every one year increase in the age of the victim at time of an officer's crime commission. Two independent variables in the model predict when a police crime arrest case is less likely to be profit-motivated. Profit-motivated police crime is rarely sex-related or violence-related. The simple odds of a profit-motivated police crime arrest case decrease by 90.4% if an officer's arrest case is sex-related and decrease by 94% if it is violence-related.

Figure 7 presents the results of predicting profit-motivated crime and included a total of 6,724 police crime arrest cases. The tree had an overall classification score of 88.6% (AUC = .908, 95% CI [.900, .917], $R^2_{ROC} = .816$) and selected the variable *violence-related police crime versus other crime* as the splitting criterion. Cases that were violence-related (node 1) were profit-motivated 4.9% of the time and cases that were not violence-related (node 2) were profit-motivated in 42% of the cases. The cases that were violence-related in node 1 were partitioned by the variable *drug-related police crime versus other types of crime*. Cases that did not involve a drug crime were only profit-motivated 2.5% of the time and cases that involved a drug crime were profit-motivated in 63.6% of the cases. Cases that were not violence-related in node 2 were further partitioned by the variable *victim age*. Cases that involved victims from birth to the age of 20 were only profit-motivated 2.9% of the time and cases that involved victims older than 20 years old were profit-motivated in 47% of the cases. The tree also included the following variables in tiers three through four: gender of victim, alcohol-related crime versus other crime type, and sex-related crime versus other crime type.

Predicting Federal Civil Rights Litigation pursuant to 42 U.S.C. §1983

The final area of prediction using the full data set for model building examines arrested officers who have also at some point in their law enforcement career been sued in federal court at least once pursuant to 42 U.S.C. §1983. Table 18 presents statistically significant Chi-Square bivariate associations at the $p < .05$ level for 96 independent variables and the dependent variable, *arrested officer named as a party defendant in a federal civil action pursuant to 42 U.S.C. §1983 at some point during career*. The strongest bivariate predictors of Section 1983 litigation are several other caused of action, including (a) 42 U.S.C. §1997 (civil plaintiff is an institutionalized person) civil defendant, where $\chi^2 (1, N = 6,724) = 1247.262, p < .001, V = .431$;

(b) 42 U.S.C. §1985 (conspiracy to interfere with civil rights) civil defendant, where $\chi^2 (1, N = 6,724) = 632.692, p < .001, V = .307$; and (c) 42 U.S.C. §1981 (equal rights under the law) civil defendant, where $\chi^2 (1, N = 6,724) = 435.624, p < .001, V = .255$. Civil rights litigation originally filed by a plaintiff in a state trial court and later removed by defense counsel to a federal district court pursuant to 28 U.S.C. §1441 is also a strong bivariate predictor, where $\chi^2 (1, N = 6,724) = 1192.487, p < .001, V = .421$.

Other moderate bivariate associations of Section 1983 federal court civil actions are (a) age of victim, where $\chi^2 (79, N = 1,848) = 159.139, p < .001, V = .293$; (b) officer's years of service at time of arrest, where $\chi^2 (43, N = 4,780) = 250.387, p < .001, V = .229$; (c) the state where the officer's employing law enforcement agency is located, where $\chi^2 (50, N = 6,724) = 346.944, p < .001, V = .227$; and (d) the most serious offense charged, where $\chi^2 (63, N = 6,724) = 320.050, p < .001, V = .218$.

A backward stepwise binary logistic regression model predicting arrested officers being named as a party defendant in federal civil rights litigation pursuant to 42 U.S.C. §1983 at some point during their policing career is presented in Table 19. Bivariate correlations computed for each of the independent variables in the model revealed that none of the variables were highly correlated with each other. None of the tolerance scores in the regression model are below .334 and no variance inflation factors are above 2.995, indicate that multicollinearity is not a problem. The Durbin-Watson score of 1.580 indicates that there is no autocorrelation. Binary logistic regression results indicate that the overall model of 16 predictors is statistically reliable in distinguishing between arrested officers who were sued in federal court pursuant to Section 1983 and those arrested officers who never have been named as a party defendant in Section 1983

federal civil rights litigation. The model correctly classified 76.4% of the cases (AUC = .743, 95% CI [.723, .764], $R_{ROC}^2 = .486$).

Fourteen of 16 independent variables in the binary logistic regression model predict when an arrested officer is likely to be named as a party defendant in a 42 U.S.C. §1983 federal court civil action at some point during his or her career as a sworn nonfederal law enforcement officer. Many of the federal court civil actions analyzed in this research study had nothing to do with the incident for which an officer was arrested. Some of the civil litigation occurred years or even decades prior to an officer being arrested for some crime(s). In other instances federal civil rights litigation directly arose out of the same operative facts as in an officer's criminal case.

Federal civil rights civil actions often include averment of more than one cause of action in the complaint filed in a federal district court. In many instances, the officers in this study were sued more than once for a variety of civil rights causes of action. Here, the simple odds that an arrested officer will be named as a party defendant in Section 1983 civil litigation are 51.5 times greater if the same officer has been named as a defendant in a civil action pursuant to 42 U.S.C. §1981 for denial of equal rights under the law.

The simple odds that an officer will be sued in their official capacity pursuant to Section 1983 are about 2 times greater if the officer was on-duty at time of committing the crime(s) for which they were arrested. The longer an officer has been employed by a law enforcement agency, the more likely they are at risk of being sued in their official capacity in a federal court civil rights civil action. The simple odds of being named in a Section 1983 civil action increase by 6.9% for every one year increase in years of service at time of arrest. There is often collateral damage to others in an officer's employing law enforcement agency as indicated by the odds

being 9.7 times greater that an officer will be sued under Section 1983 if the officer's supervisor was disciplined and/or reassigned as fallout from the arrest of the subordinate officer.

The nature of the criminal offenses in an officer's arrest case provide context for predicting when an officer is likely to be sued in a Section 1983 civil action. The simple odds of being named as a party defendant in a Section 1983 civil action at some point during an officer's law enforcement career are 1.1 times greater if an officer is arrested for kidnapping or abduction, one time greater if charged with a crime involving family violence, 6.4 times greater if arrested for crime involving cocaine, 1.54 times greater if arrested for a crime stemming from a "driving while female" encounter, and go up by 99.8% if arrested for murder or nonnegligent manslaughter.

Figure 8 presents the results of predicting a 42 U.S.C. §1983 civil defendant included a total of 6,724 arrest cases. The tree had an overall classification score of 78.2% (AUC = .722, 95% CI [.708, .737], $R^2_{ROC} = .444$) and selected the variable *official capacity versus individual capacity* as the splitting criterion. Arrested officers who were acting in their individual capacity during commission of the crime for which they were arrested (node 1) were named as party defendants in federal court Section 1983 civil actions at some point during their law enforcement careers 16.7% of the time. Arrested officers who were acting in their official capacity during commission of the crime for which they were arrested (node 2) were named as party defendants in federal court Section 1983 civil actions at some point during their law enforcement careers 32.4% of the time.

The criminal cases where an officer was acting in an individual capacity (in node 1) were partitioned by the variable *years of service*. Officers who has served as a sworn officer seven and one-half years or less at time of arrest were named as Section 1983 civil defendants at some

point during their career in 11.3% of the criminal cases, whereas officers who had served more than seven and one-half years at time of arrest were named as Section 1983 civil defendants at some point during their law enforcement career in 20.6% of the criminal cases. Criminal cases that involved officers operating in their official capacity (in node 2) were further partitioned by the variable *violence-related police crime versus other types of crime*. As to the violence-related criminal cases, 43.8% of the cases involved arrested officers who – at some point during their law enforcement career – were sued in federal court pursuant to Section 1983, but only 22.9% of the cases that were not violence-related involved an officer who was at some point named as a federal court Section 1983 civil defendant. The tree also included the following variables in tiers three through ten: geographic division, rank, most serious offense charged, state, discussion of an agency scandal/ cover up, years of service, years of service, age of victim, type of agency, and urban/rural continuum.

Part II: Sex-related Police Crime Data Set Models

There are 1,475 cases in the data set where sworn law enforcement officers were arrested for sex-related crimes during the years 2005-2011. The sex-related police crime arrest cases involve 1,070 individual officers employed by 795 nonfederal state, local, special, constable, and tribal law enforcement agencies located in 550 counties and independent cities in 48 states (all except Maine and Wyoming) and the District of Columbia. Of these, 191 of the arrested officers have more than one case ($\bar{X} = 1.38$, $Mdn = 1.00$, $Mode = 1$, $SD = 1.288$) because they have more than one victim (one criminal case per victim) and/or were arrested for a sex-related crime on more than one occasion during the study period years.

The majority of sex-related police crime arrest cases involve an officer who is known to have ultimately lost their job ($n = 1,063$, 72.1%) as a sworn officer after being charged with one or more crimes. The known final employment outcomes in the sex-related arrest cases include those in which there was no known adverse employment action taken against the officer ($n = 96$, 6.5%), cases resulting in the officer only being suspended for a period of time ($n = 316$, 21.4%), cases in which the officer was separated through voluntary resignation ($n = 505$, 34.2%), and those cases in which the officer was separated through involuntary termination ($n = 558$, 37.8%). More than half the sex-related police crime arrest cases resulted in criminal conviction ($n = 791$, 53.6%, valid 80.2%) on one or more offenses charged, however the final criminal case disposition is unknown ($n = 489$, 33.2%) in one-third of the sex-related arrest cases.

Officers Arrested for Sex-related Police Crime, Offenses Charged & Employing Agencies

Table 20 presents information on the sex-related arrest cases in terms of the arrested officers and their employing nonfederal law enforcement agencies. Almost all of the sex-related arrest cases involve male officers ($n = 1,467$, 99.5%) who were arrested. The modal category for

known officer age at time of arrest for sex-related cases is 36-39 years of age ($n = 261$, 17.6%). The youngest officer arrested for a sex-related crime was age 19 at time of arrest, and the oldest arrested officer was 74 years old (\bar{X} age = 37.88, Mdn age = 38.00, Mode age = 39, $SD = 8.636$ years). The modal category for known years of service at time of arrest for a sex-related crime is 3-5 years (\bar{X} years of service = 9.81 years, $Mdn = 8.00$ years, Mode = 2 years, $SD = 7.650$ years). Most of the sex-related arrest cases involve sworn officers employed in patrol or street-level nonsupervisory positions, including officers, deputies, troopers, and detectives ($n = 1,221$, 82.8%). Almost half of the sex-related arrest cases involves sex crimes that occurred while on-duty ($n = 682$, 46.2%). The majority of the cases ($n = 919$, 62.3%) involve arrests made by some law enforcement agency other than the department where the arrested officer was employed.

Most of the sex-related arrest cases involve sworn officers employed by municipal police departments ($n = 1,040$, 70.5%) or sheriff's offices ($n = 280$, 19.0%). Officers arrested for sex-related crimes were also employed by primary state police agencies ($n = 61$, 4.1%), county police departments ($n = 30$, 2.0%), or other types of nonfederal law enforcement agencies ($n = 64$, 4.4%). The modal category for agency size by number of full-time sworn personnel is 1,000 or more sworn officers ($n = 349$, 23.6%). Most of the employing law enforcement agencies were located in a nonrural metropolitan county or independent city ($n = 1,229$, 83.3%). The employing agencies are located throughout the United States, including in Southern states ($n = 658$, 44.6%), Western states ($n = 316$, 21.4%), Northeastern states ($n = 259$, 17.6%), and Midwestern states ($n = 242$, 16.4%).

Table 21 presents the sex-related arrest cases in terms of the most serious offense charged. There are 40 separate offense categories represented as the most serious offense charged in sex-related police crime arrest cases during the years 2005-2011. Most common in

the sex-related cases as the most serious offense charged are forcible fondling ($n = 352$, 23.9%), forcible rape ($n = 322$, 21.8%), statutory rape ($n = 100$, 6.8%), unclassified sex crimes ($n = 98$, 6.6%), forcible sodomy ($n = 94$, 6.4%), pornography and obscene material ($n = 86$, 5.8%), intimidation and harassment ($n = 52$, 3.5%), online solicitation of a child ($n = 44$, 3.0%), and prostitution ($n = 42$, 2.8%).

Victims of Sex-related Police Crime

Victim characteristics in sex-related police crime arrest cases in years 2005-2011 are presented in Table 22. Victim information is particularly difficult to ascertain from news reports and even official court records (when available) in criminal cases involving sex offenses. For example, exact victim age is unknown ($n = 661$, 44.8%) due to missing data. We were, however, able to determine whether the victim of a sex-related case was a child (birth to 17 years of age) or an adult (ages 18 and older). Almost half of the known victims are children ($n = 721$, valid 52.4%). Most of the victims of sex-related police crime arrest cases are either an unrelated child ($n = 527$, valid 39.3%) or an adult who is a stranger or nonstranger acquaintance ($n = 658$, valid 49.1%).

Predicting Conviction in Sex-related Police Crime Arrest Cases

The regression models in this section predict criminal conviction on any offense charged in sex-related police crime arrest cases. Conviction data are available on two-thirds ($n = 986$, 66.8%) of the sex-related arrest cases. Of those sex-related cases with known criminal case outcomes, most of the officers arrested for sex-related crimes were convicted ($n = 791$, 80.2%) on at least one criminal offense charged against the arrested officer. Bivariate associations are presented in Table 23. Chi-Square associations are statistically significant at $p < .05$ for 23 independent variables and the dependent variable, *conviction on any offense charged*. There are

four bivariate associations of moderate strength as indicated by Cramer's V scores for the statistically significant Chi-Square associations. They are age of the victim, where $\chi^2 (50, N = 541) = 86.980, p = .001, V = .401$; the State where the arrested officer's employing law enforcement agency is located, where $\chi^2 (48, N = 986) = 80.347, p = .002, V = .285$; years of service at time of arrest, where $\chi^2 (34, N = 820) = 52.020, p = .025, V = .252$; and victim's relationship to the arrested officer, where $\chi^2 (7, N = 905) = 36.740, p < .001, V = .201$.

Table 24 presents a backward stepwise binary logistic regression model predicting conviction in sex-related police crime arrest cases. Bivariate correlations computed for each of the independent variables in the model revealed that none of the variables were highly correlated with each other. Multicollinearity is not a problem as indicated by no tolerance scores below .905 and no variance inflation factors above 1.105. The Durbin-Watson score is 1.587 and indicates that autocorrelation is not a problem. Logistic regression results indicate that the overall model of four predictors is statistically reliable in distinguishing between conviction and nonconviction in sex-related police crime arrest cases. Wald statistics indicate that all of the independent variables in the binary logistic regression model significantly predict conviction in sex-related police crime arrest cases. The regression model correctly classified 83.7% of the cases ($AUC = .673, 95\% \text{ CI } [.621, .725], R_{ROC}^2 = .346$).

Context for prediction of conviction in sex-related police crime arrest cases is provided by interpretation of odds ratios. The greatest predictor conviction is being charged with pornography and obscene material offenses. The simple odds of conviction in sex-related police crime arrest cases are 4.6 times greater if the arrested officer is charged with crimes involving pornography and obscene material. Job loss also predicts conviction in sex-related cases as the simple odds of conviction are 4.2 times greater if the final adverse employment action against the

officer is job loss through either involuntary termination or voluntary resignation. Officers arrested for sex-related crimes involving a child are more likely to be convicted than officers whose victims are adults. The simple odds of conviction are 1.1 times greater in sex-related police crime arrest cases where the victim is a child. Years of service at time of arrest is also a slight predictor of conviction. The simple odds of conviction in sex-related police crime arrest cases goes up by 5.8% for every one year increase in years of service at time of arrest.

Figure 9 presents the results of predicting conviction and included a total of 986 arrest cases. The tree had an overall classification score of 81.9% (AUC = .712, 95% CI [.699, .754], $R^2_{ROC} = .424$) and selected the variable *job lost* as the splitting criterion. Officers who had lost their job (node 1) were convicted in 83.8% of the cases. In contrast, officers who kept their job (node 2) were convicted in 63.6% of the cases. The officers who lost their job in node 1 were partitioned by the variable *victim's relationship to the offender*. Cases that involved a victim who was an unrelated child, a child or stepchild of the offender or former boy/girlfriend of the offender had a conviction rate of 91.3%. In contrast, cases that involved a victim who was a current spouse, other relative of the offender, stranger to the offender, current boy/girlfriend of the offender, or ex-spouse of the offender had a conviction rate of 63.6%. The officers who kept their job subsequent to being arrested in node 2 were partitioned by the variable *age of victim*. Officers were convicted 56% of the time when the victim was 19 years of age or older and were convicted 72% of the time when the victim was younger than 19 years of age. The tree also included the following variables in tiers three: state, years of service, and rank.

Predicting Job Loss in Sex-related Police Crime Arrest Cases

This section presents the regression models predicting job loss as the final adverse employment action taken against an officer following his or her arrest for a sex-related police

crime. Chi-Square associations are presented in Table 25. Bivariate associations are statistically significant at the $p < .05$ level for each of 35 independent variables and the dependent variable, *job lost*. There are, however, only four bivariate associations of moderate strength as indicated by the Cramer's V scores for the statistically significant Chi-Square statistics. They are the year when the officer was arrested, where $\chi^2 (6, N = 1,475) = 135.487, p < .001, V = .303$; the State where the arrested officer's employing law enforcement agency is located, where $\chi^2 (48, N = 1,475) = 111.725, p < .001, V = .275$; years of service at time of arrest, where $\chi^2 (36, N = 1,195) = 62.775, p = .004, V = .229$; and officer age at time of his or her arrest, where $\chi^2 (46, N = 1,397) = 68.062, p = .019, V = .221$.

Table 26 presents a backward stepwise binary logistic regression model predicting job loss in sex-related police crime arrest cases. Bivariate correlations computed for each of the independent variables in the regression model indicate that none of the variables are highly correlated with each other. Multicollinearity is not a problem in the model as indicated by no tolerance scores below .649 and no variance inflation factors above 1.541. The Durbin-Watson score of 1.634 indicates that autocorrelation is not a problem. Logistic regression results suggest that the overall model of nine predictors is statistically reliable for sex-related police crime arrest cases in distinguishing between officers who kept their jobs after being arrested and officers who lost their job. Wald statistics indicate that all of the independent variables in the model significantly predict job loss in sex-related police crime arrest cases. The regression model correctly classified 82.6% of the cases (AUC = .772, 95% CI [.733, .810], $R_{ROC}^2 = .544$).

Interpretation of odds ratios provides context for prediction of job loss in sex-related police crime arrest cases. Six of the independent variables in the logistic regression model predict when an officer is more likely to lose his or her job as a sworn law enforcement officer

after being arrested for a sex-related police crime. The single largest predictor of job loss in sex-related criminal cases is conviction on at least one of the charged offenses. The simple odds of job loss are 2.8 times greater when the officer is convicted of a sex-related crime. Characteristics of the sex-related crimes also predict job loss. Sex-related crimes are committed by officers both on- and off-duty. The simple odds of job loss are 1.4 times greater if the sex-related crime was committed by an officer in his or her official capacity as a sworn law enforcement officer. Similarly, the simple odds of job loss are 1.7 times greater if the sex-related crime(s) for which an officer was arrested involved a driving while female encounter. Officers arrested for sex-related police crimes are prone to commit other types of police misconduct; the simple odds of job loss are 1.2 times greater if at some point during the officer's career he or she was named as a party defendant in federal civil rights litigation pursuant to 42 U.S.C. §1983. Some of the predictors in the model show when an officer is less likely to lose his job as a sworn law enforcement officer subsequent to an arrest for committing a sex-related crime. Older officers are less likely to lose their jobs; the simple odds of job loss go down by 3.5% for every one year increase in the officer's age at time of arrest. Oddly, the simple odds of job loss decrease by 85.5% if the sex-related crime for which the officer was arrested also involves marijuana.

Figure 10 presents the results of predicting job loss and included a total of 1,475 arrest cases. The tree had an overall classification score of 78.8% (AUC = .786, 95% CI [.758, .813], $R^2_{ROC} = .572$) and selected the variable *year of arrest* as the splitting criterion. Officers who were arrested before 2007 (node 1) lost their job in 55.5% of the cases. In contrast, officers who were arrested after 2007 (node 2) lost their job in 82.7% of the cases. The officers arrested prior to 2007 in node 1 were partitioned by the variable *officer was suspended*. Officers who had been previously suspended lost their job in 43.2% of the cases and officers who had not been

suspended lost their jobs in 73% of the cases. The officers arrested after the year 2007 in node 2 were partitioned by the variable *criminal conviction*. Officers who were convicted lost their jobs in 84.9% of the cases and officers who were not convicted lost their job in 71.3% of cases. The tree also included the following variables in tiers three through five: being named as a 42 U.S.C. §1983 civil defendant (at some point during an officer's law enforcement career), urban/rural continuum, geographic division, state, method of crime detection, citizen complaint as method of crime detection, the number of part-time sworn personnel employed by the arrested officer's employing law enforcement agency, and the number of full-time sworn personnel employed by the arrested officer's employing law enforcement agency.

Predicting Child Victims in Sex-related Police Crime Arrest Cases

The next set of regression models predict child victims in sex-related police crime arrest cases. Bivariate associations are presented in Table 27. Chi-Square calculations are statistically significant at $p < .05$ for 54 independent variables and the dependent variable, *child victim* (where adult victim = 0 and child victim = 1). Three of the bivariate associations are strong as indicated by Cramer's V scores where $V > .40$. They are crimes committed in the arrested officer's official capacity, where $\chi^2(1, N = 1,377) = 330.080, p < .001, V = .490$; duty status at time of commission of the crime, where $\chi^2(1, N = 1,377) = 323.355, p < .001, V = .485$; and crimes that are acts of police sexual violence, where $\chi^2(1, N = 1,377) = 290.300, p < .001, V = .459$. The bivariate associations of adult versus child victim are of moderate strength in 14 instances, including among others, statutory rape, where $\chi^2(1, N = 1,377) = 179.498, p < .001, V = .361$; the criminal offense of official misconduct, official oppression, or violation of oath, where $\chi^2(1, N = 1,377) = 161.527, p < .001, V = .342$, and driving while female encounters, where $\chi^2(1, N = 1,377) = 142.850, p < .05, V = .322$.

A backward stepwise logistic regression model predicting child victims in sex-related police crime arrest cases is presented in Table 28. Bivariate correlations computed for each of the independent variables in the logistic regression model revealed that none of the variables are highly correlated with each other. Multicollinearity is not a problem as indicated by no tolerance scores below .449 and no variance inflation factors above 2.229. The Durbin-Watson score of 1.664 indicates that autocorrelation is not a problem. Logistic regression results indicate that the overall model of 20 predictors is statistically reliable in distinguishing between sex-related police crime arrest cases with adult victims and sex-related police crime arrest cases with child victims. The model correctly classified 85.9% of the cases (AUC = .920, 95% CI [.902, .938], $R^2_{ROC} = .844$). Wald statistics indicate that all of the independent variables in the logistic regression model significantly predict child victims in sex-related police crime arrest cases.

Odds ratio interpretations provide context for prediction of child victims in sex-related police crime arrest cases. Eight of the 20 predictors in the logistic regression model indicate when the victim of a sex-related police crime arrest case is *more likely to be a child* than an adult. Certain types of sex crimes tend to involve child victims. The simple odds of the victim being a child are 2.9 times greater if the arrested officer is charged with crimes involving pornography and obscene material. Similarly, the simple odds of the victim being a child are 2.2 times greater if the arrested officer was charged with an unclassified sex crime (that is, a sex-related criminal offense not specifically included in the coding protocol for this study) such as promoting the sexual performance of a child, child enticement, corruption of a minor, or sexual coercion. Crimes involving fondling often involve a child victim; the simple odds of the victim being a child are 2.4 times greater if the arrested officer is charged with offenses relating to forcible fondling. The gender of the victim also predicts child victims. The simple odds that the

victim is a child are more than five times greater if the victim is male. Sex-related police crime arrest cases are more likely to result in a criminal conviction if the victim is a child; the simple odds of the victim being a child were 1.2 times greater if the arrested officer is convicted on at least one offense charged. Finally, the simple of odds of the victim being a child increased 17.2% if the crime for which an officer was arrested involved family violence.

Some of the independent variables in the logistic regression model predict when the victim is *less likely to be a child*. The victims of sex-related police crime arrest cases are less likely to be a child in cases where the arrested officer is employed by a large police department in a metropolitan (that is, urban or suburban) county or independent city. The simple odds of the victim being a child decrease by 17.7% for every one unit increase in the size of the arrested officer's employing law enforcement agency (on a ten-point scale) based on the number of sworn personnel. Likewise, the simple odds of a child victim decrease by 17.6% for every one unit increase in rurality (on a nine-point scale) based on the population of the county where the arrested officer's employing agency is located. Duty status at time of commission of the crime for which an officer was arrested also predicts whether the victim of a sex-related police crime arrest case is an adult or child. The simple odds of the victim being a child decrease by 83.4% if the arrested officer was on-duty when the crime for which he was arrested was allegedly committed. The on-duty sex-related crimes of the arrested officers are more likely to involve an adult victim if the offenses are also violence-related crimes. For example, the simple odds of the victim being a child decrease by 62.7% if the crime is an act of police sexual violence. The odds ratios are similar if the arrested officer is charged with aggravated assault, kidnapping, abduction, or false imprisonment, or intimidation / harassment in sex-related police crime arrest cases.

Figure 11 presents the results of predicting child victims for the sex-related cases and included a total of 1,377 police crime arrest cases. The tree had an overall classification score of 79.8% (AUC = .835, 95% CI [.814, .857], $R^2_{ROC} = .670$) and selected the variable *official capacity versus individual capacity* as the splitting criterion. Officers operating in their individual capacity (node 1) had child victims in 72.8% of the cases. In contrast, officers operating in an official capacity (node 2) had child victims in 23.9% of the cases. The officers who were operating in an individual capacity (node 1) were partitioned by the variable *kidnapping/abduction*. Cases involving a kidnapping or abduction had child victims in 14.3% of the cases. Cases that did not involve a kidnapping or abduction had child victims in 76% of the cases. The officers who were operating in an official capacity (node 2) were partitioned by the variable *gender of victim*. Cases that involved a female victim were also child victims in 19.4% of the cases and cases with a male victim were also a child victim in 66.2% of the cases. The tree also included the following variables in tier three through five: indecent exposure, violence-related crime versus other crime type, driving while female encounter, state, and urban/rural continuum.

Predicting Conviction in Police Sexual Violence Arrest Cases

This section presents regression models that predict criminal conviction on any offense charged in sex-related police crime arrest cases involving police sexual violence. Conviction data are available in more than two-thirds ($n = 431$, 69.3%) of the police sexual violence cases. In the police sexual violence cases with known criminal case dispositions, the majority of the arrest cases resulted in criminal conviction ($n = 345$, valid 80%) on at least one offense charged against the arrested officer. Bivariate associations are presented in Table 29. Chi-Square associations are statistically significant at $p < .05$ for 13 independent variables and the dependent

variable, *conviction on any offense charged*. Only three of the bivariate associations are of moderate strength as indicated by Cramer's V scores. They are job lost, where $\chi^2 (1, N = 431) = 22.139, p < .001, V = .227$; victim's relationship, where $\chi^2 (6, N = 427) = 20.988, p = .002, V = .222$; and year of arrest, where $\chi^2 (6, N = 431) = 18.185, p = .006, V = .205$.

Table 30 presents a backward stepwise binary logistic regression model predicting conviction in sex-related police crime arrest cases involving acts of police sexual violence. Bivariate correlations computed for each of the independent variables in the model revealed that none of the variables were highly correlated with each other. Multicollinearity is not a problem as indicated by no tolerance scores below .983 and no variance inflation factors above 1.018. Autocorrelation is not a problem as indicated by the Durbin-Watson score of 1.562. Logistic regression results indicate that the overall model of four predictors is statistically reliable in distinguishing between conviction and nonconviction in police sexual violence arrest cases. Wald statistics indicate that all of the independent variables in the model significantly predict conviction in police sexual violence arrest cases. The binary logistic regression model correctly classified 80.8% of the cases (AUC = .711, 95% CI [.647, .774], $R_{ROC}^2 = .422$).

Interpretation of the odds ratios provide context for prediction of criminal conviction in police sexual violence arrest cases. Three of the four independent variables in the regression model predict when conviction is more likely. Here again, sex-related arrest cases involving a child victim are more likely to result in the arrested officer's criminal conviction. The simple odds of conviction are 2.7 times greater if the victim of a sex-related arrest case involving police sexual violence is a child. The type of sex offense predicts whether an officer arrested for acts of police sexual violence will be convicted of a crime. The simple odds of conviction are 2.1 times

greater if the officer was arrested for forcible sodomy. Conversely, the simple odds of conviction decrease by 54.1% if the officer was arrested for forcible fondling.

Figure 12 presents the results of predicting conviction in police sexual violent arrest cases and included a total of 431 police crime arrest cases. The CHAID tree had an overall classification score of 80.0% (AUC = .680, 95% CI [.615, .746], $R_{ROC}^2 = .360$) and selected the variable *job lost* as the splitting criterion. Officers who had kept their job (node 1) were convicted in 56.4% of the cases. In contrast, officers who lost their job (node 2) were convicted in 83.5% of the cases. The officers who kept their job in node 1 were not partitioned by another variable. The officers who lost this job in node 2 were partitioned by the variable *forcible fondling*. Cases that did not involve forcible fondling resulted in conviction in 88.3% of the cases and cases that involved forcible fondling resulted in conviction in 77.2% of the cases. The tree also included the variable *adult victim versus child victim* in tier 3.

Predicting Job Loss in Police Sexual Violence Arrest Cases

Regression models predicting job loss as the final adverse employment outcome taken against an officer following his or her arrest for sex-related crimes involving acts of police sexual violence are presented in this section. Chi-Square associations are presented in Table 31. Bivariate associations are statistically significant at $p < .05$ for each of 28 independent variables and the dependent variable, *job loss*. Six of the bivariate associations are of moderate strength as indicated by the Cramer's V scores for the statistically significant Chi-Square statistics. They are the State where the arrested officer's employing law enforcement agency is located, where $\chi^2 (45, N = 622) = 78.683, p = .001, V = .356$; years of service at time of arrest, where $\chi^2 (29, N = 495) = 61.583, p < .001, V = .353$; year of arrest, where $\chi^2 (6, N = 622) = 60.900, p < .001, V = .313$; internal crime against the organization, where $\chi^2 (1, N = 622) = 60.900, p < .001, V = .290$,

conviction, where $\chi^2 (1, N = 431) = 22.139, p < .001, V = .227$; and years of service (categorical variable), where $\chi^2 (10, N = 622) = 25.372, p = .005, V = .202$.

A backward stepwise binary logistic regression model predicting job loss in cases involving acts of police sexual violence is presented in Table 32. Bivariate correlations for each of the independent variables in the regression model indicate that none of the variables are highly correlated with each other. Multicollinearity is not a problem in the model as indicated by no tolerance scores below .966 and no variance inflation factors above 1.035. The Durbin-Watson score of 1.562 indicates that autocorrelation is not a problem in the model. Logistic regression results indicate that the overall model of six predictors is statistically reliable for cases of police sexual violence in distinguishing between officers who kept their job after being arrested and officers who lost their job. Wald statistics indicate that all of the independent variables in the binary logistic regression model significantly predict job loss in sex-related police crime arrest cases involving acts of police sexual violence. The regression model correctly classified 89.5% of the cases (AUC = .735, 95% CI [.651, .819], $R_{ROC}^2 = .470$).

Context is provided for prediction of job loss in sex-related arrest cases involving police sexual violence through interpretation of odds ratios. Four of the independent variable in the logistic regression model predict when an officer is more likely to lose his or her job as a sworn officer after being arrested for a sex-related crime involving an act of police sexual violence. Conviction predicts job loss in police sexual violence arrest cases. The simple odds of job loss are 4.7 times greater if the officer is convicted of at least one criminal offense charged in the case involving police sexual violence. Predatory behavior in police sexual violence arrest cases also predicts job loss. The simple odds of job loss are 2.2 times more likely if the police sexual violence arrest case also involves a driving while female encounter. Police sexual violence cases

are crimes against persons and rarely, if ever, constitute an internal crime against the organization or a crime by the organization against the officer. As such, the simple odds of job loss increase by 29.7% if the crime involving police sexual violence is neither an internal or organizational crime. The simple odds of job loss in police sexual violence arrest cases increase by 89.4% for every one unit categorical increase in the number of part-time sworn officers employed by the same law enforcement agency as the arrested officer. Two of the independent variables in the model predict when an officer is more likely to keep his or her job after being arrested for a crime involving police sexual violence. The longer an officer has been employed the less likely they are to lose their job. The simple odds of job loss in police sexual violence arrest cases go down by 23% for every one unit (three year) categorical increase in years of service at time of arrest. The years of service categorical variable groups years of service in three-year increments. Also, the simple odds of job loss in police sexual violence arrest cases decrease by 91.8% if the arrested officer is also charged with a weapons law offense.

Figure 13 presents the results of predicting job loss and included a total of 622 cases. The tree had an overall classification score of 84.1%, (AUC = .794, 95% CI [.748, .840], $R^2_{ROC} = .496$) and selected the variable *year of arrest* as the splitting criterion. Officers who were arrested before the year 2007 (node 1) lost their job in 60.2% of the cases. In contrast, officers who were arrested after the year 2007 (node 2) lost their job in 86.4% of the cases. The officers arrested prior to the year 2007 in node 1 were partitioned by the variable *suspended for a period of time*. Officers who had been previously suspended lost their job in 48.4% of the cases and officers who had not been suspended lost their jobs in 76.8% of the cases. The officers arrested after the year 2007 in node 2 were partitioned by the variable *criminal conviction versus nonconviction*. Officers who were convicted lost their jobs in 89.4% of the cases and officers

who were not convicted lost their job in 72.1% of cases. The tree also included the following variables in tiers three through four: geographic division and state.

Predicting Conviction in Driving While Female Police Crime Arrest Cases

Driving while female encounters are those incidents where a police officer initiates a bogus traffic stop to harass, intimidate, and/or sexually assault female motorists. The regression models in this section predict conviction in sex-related police crime arrest cases involving driving while female encounters ($N = 174$). Criminal case final disposition data are available in a majority of the driving while female cases ($n = 126$, 72.4%). Of those cases with known criminal case outcomes, most of the officers were convicted ($n = 103$, valid 81.7%) on at least one criminal offense charged against the arrested officer. Bivariate associations are presented in Table 33. Chi-Square associations are statistically significant at $p < .05$ for 18 independent variables and the dependent variable, *conviction on any offense charged*. The bivariate association for conviction and the number of full-time sworn officers employed (categorical) is strong, where $\chi^2(9, N = 126) = 22.232, p = .008, V = .420$. There are eight bivariate associations of moderate strength: age (categorical), where $\chi^2(8, N = 126) = 18.588, p = .017, V = .384$; year of officer's arrest, where $\chi^2(6, N = 126) = 14.407, p = .025, V = .338$; alcohol-related police crime arrest cases, where $\chi^2(1, N = 126) = 9.895, p = .002, V = .280$; burglary, where $\chi^2(1, N = 126) = 9.101, p = .003, V = .269$; internal versus organizational crime, where $\chi^2(1, N = 126) = 7.204, p = .007, V = .239$; sexual assault with an object, where $\chi^2(1, N = 126) = 6.081, p = .014, V = .220$; rank by function, where $\chi^2(1, N = 126) = 5.769, p = .016, V = .214$; and, forcible fondling, where $\chi^2(1, N = 126) = 5.277, p = .022, V = .205$.

Table 34 presents a backward stepwise logistic regression model predicting conviction in sex-related police crime arrest cases involving driving while female encounters. Bivariate

correlations computed for each of the independent variables in the model revealed that none of the variables were highly correlated with each other. Multicollinearity is not a problem as indicated by no tolerance scores below .962 and no variance inflation factors above 1.040. The Durbin-Watson score is 1.700 indicating that autocorrelation is not a problem in the model. Logistic regression results indicate that the overall model of five predictors is statistically reliable in distinguishing between conviction and nonconviction in sex-related police crime arrest cases involving a driving while female encounter. Wald statistics indicate that all of the independent variables in the binary logistic regression model significantly predict conviction in driving while female encounter cases. The regression model correctly classified 85.7% of the cases (AUC = .831, 95% CI [.741, .921], $R_{ROC}^2 = .662$).

Context for prediction of conviction in sex-related police crime arrest cases involving driving while female encounters is provided by interpretation of odds ratios. Two of the independent variables in the model predict when the odds of conviction increase. The simple odds of conviction in driving while female encounter arrest cases is 3.2 times greater if the arrested police officer has been sued in federal court pursuant to 42 U.S.C. §1983 (civil action for deprivation of rights) at some point during his or her law enforcement career. Driving while female encounter arrest cases involve crimes against a person and do not involve crimes against the organization or crimes by the organization against the officer. This is demonstrated where the simple odds of conviction increase by 23% if the driving while female encounter arrest case involves a crime against a person and is neither an internal or organizational crime. The other three independent variables in the logistic regression model predict when the odds of conviction decrease in sex-related police crime arrest cases involving driving while female encounters. The simple odds of conviction in driving while female cases decrease by 87.1% if the officer is

charged with the criminal offense of sexual assault with an object. Similarly, the simple odds of conviction decrease by 73.4% in driving while female cases if the arrested officer is charged with the criminal offense of forcible fondling. Additionally, the simple odds of conviction in driving while female encounter arrest cases decrease by 93.3% if the crime is also alcohol-related.

Figure 14 presents the results of predicting conviction and included a total of 126 cases. The tree had an overall classification score of 81.7% (AUC = .736, 95% CI [.637, .835], $R_{ROC}^2 = .472$) and selected the variable *year of arrest* as the splitting criterion. Officers who were arrested in the year 2005 (node 1) were convicted in 66.7% of the cases. Officers who were arrested during years 2006-2011 were convicted in 90.1% of the cases. The officers who kept their job, in node 1, were not partitioned by another variable. The officers who lost their jobs, in node 2, were partitioned by the variable *42 U.S.C. §1983 civil defendant at some point during an officer's law enforcement career*. Cases that did not involve an officer who had been named as a party-defendant pursuant to 42 U.S.C. §1983 in a federal court civil rights lawsuit (at some point during his or her law enforcement career) resulted in conviction in 81.6% of the cases. In contrast, cases that involved an officer who had at some point been sued pursuant to 42 U.S.C. §1983 resulted in conviction in 97.7% of the cases.

Predicting Job Loss in Driving While Female Police Crime Arrest Cases

This section presents the regression models for predicting job loss as the final adverse employment actions taken against an officer following his arrest for a sex-related police crime arrest case involving a driving while female encounter. Chi-Square associations of job loss are presented in Table 35. Four of the bivariate associations of job loss are strong as indicated by the Cramer's V score $> .400$. They are: the State where the officer's employing law enforcement agency is located, where $\chi^2 (33, N = 174) = 53.896, p = .012, V = .557$; victim age difference,

where $\chi^2 (28, N = 174) = 51.795, p = .004, V = .546$; officer's years of service, where $\chi^2 (22, N = 144) = 42.173, p = .006, V = .541$; and age, where $\chi^2 (33, N = 168) = 47.043, p = .054, V = .529$. There are also five bivariate associations of job loss that are of moderate strength: victim age (categorical), where $\chi^2 (7, N = 174) = 22.217, p = .002, V = .357$; year of arrest, where $\chi^2 (6, N = 174) = 15.536, p = .016, V = .299$; rank, where $\chi^2 (4, N = 174) = 14.145, p = .007, V = .285$; internal versus organizational crime, where $\chi^2 (1, N = 174) = 13.514, p < .001, V = .279$; and, indecent exposure, where $\chi^2 (1, N = 174) = 12.402, p < .001, V = .267$.

Table 36 presents a backward stepwise binary logistic regression model predicting job loss in sex-related police crime arrest cases involving driving while female encounters. There are only two independent variables in the model predicting job loss. Neither of the independent variables are highly correlated with each other. Multicollinearity is not a problem, but the tolerance scores and variance inflation factors = 1 for both independent variables in the model. Autocorrelation is not a problem as indicated by a Durbin-Watson score of 1.587. Logistic regression results indicate that the overall model of two predictors is statistically reliable in distinguishing between cases where officers who lost their jobs and officers who kept their jobs after being arrested for sex-related police crimes involving a driving while female encounter. Wald statistics indicated that the independent variables in the model significantly predict job loss. The regression model correctly classified 93.3% of the cases (AUC = .766, 95% CI [.671, .860], $R^2_{ROC} = .532$).

Context for prediction of job loss in sex-related police crime arrest cases involving driving while female encounters is provided by interpretation of odds ratios. The cases involving driving while female encounters are crimes against persons. The simple odds of job loss go up by 42.9% in driving while female encounter arrest cases when the underlying nature of the crime

is not an internal crime against the organization nor a crime by the organization against the officer. The difference in age between the age of the arrested officer and the age of the victim also predicts job loss in these cases. The simple odds of job loss in sex-related police crime arrest cases involving driving while female encounters go down by 6.9% for every one year increase in the difference in age between the age of the arrested officer and the age of the victim.

Figure 15 presents the results of predicting job loss and included a total of 174 arrest cases. The tree had an overall classification score of 84.5% (AUC = .776, 95% CI [.681, .870], $R^2_{ROC} = .552$) and selected the variable *internal crime versus organizational crime* as the splitting criterion. Officers who committed an internal crime or crime against the organization (node 1) lost their job in 73.4% of the cases. In contrast, officers committed a crime against a person (node 2) lost their job in 93.7% of the cases. The officers who committed either an internal crime or crime against the organization in node 1 were partitioned by the variable *victim age difference*. Cases that involved a victim age difference that was unknown resulted in job loss in 84.6% of the cases. In contrast, cases that involved a known victim age difference (that is, the difference in years between the age of the arrested officer and the age of the victim) resulted in job loss in 51.9% of the cases. The officers who committed crimes against a person in node 2 were partitioned by the variable *official misconduct*. Officers who were not charged with the crime of official misconduct lost their jobs in 97% of the cases and officers who were charged with the crime of official misconduct lost their jobs in 86.2% of the cases.

Part III: Alcohol-related Police Crime Data Set Models

There are 1,405 cases in the data set where sworn officers were arrested for alcohol-related crimes during the years 2005-2011. The alcohol-related police crime arrest cases involve 1,283 individual officers employed by 814 nonfederal state, local, special, constable, and tribal law enforcement agencies located in 564 counties and independent cities in all 50 states and the District of Columbia. Of these, 81 of the arrested officers had more than one case ($\bar{X} = 1.10$, $Mdn = 1.00$, $Mode = 1$, $SD = .452$), because they had more than one victim (one criminal case per victim) and/or were arrested for an alcohol-related crime on more than one occasion during the study period years.

More than one-third of the alcohol-related arrest cases involve an officer who is known to have lost his or her job ($n = 533$, 37.9%) subsequent to being arrested. The known final employment outcomes in the alcohol-related arrest cases include those in which there was no known adverse employment action taken against the arrested officer ($n = 260$, 18.5%), cases resulting in the arrested officer being suspended for a period of time ($n = 612$, 43.6%), cases in which the arrested officer was separated through voluntary resignation ($n = 263$, 18.7%), and cases in which the arrested officer was separated through involuntary termination ($n = 270$, 19.2%). Relatively few of the alcohol-related DUI arrest cases are known to have resulted in criminal conviction ($n = 492$, 35.0%, valid 75.2%) on at least one criminal offense charged against the arrested officer.

Included in the alcohol-related police crime arrest cases are 960 driving under the influence (DUI) arrests during the years 2005-2011. The alcohol-related police DUI arrest cases involve 924 individual officers employed by 621 nonfederal state, local, special, constable, and tribal law enforcement agencies located in 464 counties and independent cities in all 50 states

and the District of Columbia. Of these, 27 of the arrested officers had more than one alcohol-related DUI case ($\bar{X} = 1.04$, $Mdn = 1.00$, $Mode = 1$, $SD = .256$), because they had more than one victim (one criminal case per victim) and/or were arrested for an alcohol-related DUI on more than one occasion during the study years while employed as a sworn law enforcement officer.

Less than one-third of the officers arrested for DUI are known to have lost their job ($n = 303$, 31.6%) after being arrested. The known final employment outcomes in the alcohol-related DUI arrest cases include those cases in which there was no adverse employment action taken against the arrested officer ($n = 202$, 21.0%), cases resulting in the arrested officer being suspended for a period of time ($n = 455$, 47.4%), cases in which the arrested officer was separated through voluntary resignation ($n = 167$, 17.4%), and those cases in which the arrested officer was separated through involuntary termination ($n = 136$, 14.2%). Less than one-third of the alcohol-related DUI arrest cases resulted in criminal conviction ($n = 303$, 31.6%, valid 80.2%). The final disposition in the criminal cases is unknown ($n = 582$, 60.6%), however, in many of the DUI cases.

Officers Arrested for Alcohol-related Police Crime, Offenses Charged & Employers

Table 37 presents information on the alcohol-related arrest cases in terms of the arrested officers and their employing nonfederal law enforcement agencies. The majority of the alcohol-related cases involve male officers ($n = 1,314$, 93.5%) who were arrested. The youngest officer arrested for an alcohol-related crime was age 20 at time of arrest, and the oldest arrested officer was 66 years old (\bar{X} age = 36.70, Mdn age = 37.00, $Mode$ age = 38, $SD = 8.379$ years). Most of the alcohol-related arrest cases involve sworn officers employed in patrol or street-level nonsupervisory positions, including officers, deputies, troopers, and detectives ($n = 1,138$,

81.0%). Most of the alcohol-related cases involved crimes committed while the officer was off-duty ($n = 1,235$, 87.9%). The majority of the alcohol-related cases involve arrests made by some other law enforcement agency ($n = 1,009$, 71.8%) and were not arrests made by the agency where the arrested officer was employed.

Most of the alcohol-related arrest cases involve officers employed by municipal police departments ($n = 1,028$, 73.2%) or sheriff's offices ($n = 214$, 15.2%). Officers arrested for alcohol-related crimes were also employed by primary state police agencies ($n = 74$, 5.3%), county police departments ($n = 54$, 3.8%), special police departments ($n = 24$, 1.7%), tribal police departments ($n = 7$, 0.5%), or other types of nonfederal law enforcement agencies. The modal category for agency size by number of full-time sworn personnel is 1,000 or more sworn officers ($n = 399$, 28.4%). Most of the employing law enforcement agencies were located in a nonrural metropolitan county or independent city ($n = 1,212$, 86.3%). The employing law enforcement agencies are located throughout the United States, including in Southern states ($n = 548$, 39.0%), Midwestern states ($n = 358$, 25.5%), Northeastern states ($n = 309$, 22.0%), and Western states ($n = 190$, 13.5%).

Table 38 presents the alcohol-related arrest cases in terms of the most serious offense charged. There are 38 separate offense categories representing the most serious offense charged in alcohol-related police crime arrest cases during the years 2005-2011. Most common are DUI ($n = 817$, 58.1%), simple assault ($n = 149$, 10.6%), aggravated assault ($n = 103$, 7.3%), weapons law violations ($n = 47$, 3.3%), forcible fondling ($n = 27$, 1.9%), disorderly conduct ($n = 27$, 1.9%), murder and nonnegligent manslaughter ($n = 26$, 1.9%), forcible rape ($n = 26$, 1.9%), and destruction of property / vandalism ($n = 23$, 1.6%).

Victims of Alcohol-related Police Crime

Table 39 presents victim characteristics in alcohol-related police crime arrest cases during years 2005-2011. Many of the arrest cases—including most of the DUI cases not involving traffic accidents and injuries—do not involve crimes with victims. Where victim information is relevant and available in alcohol-related arrest cases, the victims are most often female ($n = 263$, valid 52.1%) and adults age 18 or older ($n = 495$, valid 87.8%). Most of the known victims are either strangers to the arrested officer or nonstranger acquaintances ($n = 382$, valid 69.1%). Sometimes alcohol-related police crime arrest cases involve victims who are also police officers ($n = 58$, 4.1%, valid 10.4%).

Incident Events in Police DUI Arrest Cases

Table 40 presents the DUI arrest cases in terms of DUI event incidents and characteristics. Some of the arrest cases involved officers who were DUI while *actually* on-duty in a police vehicle ($n = 42$, 4.4%), in a police vehicle while out of the officer's jurisdiction ($n = 28$, 2.9%), or off-duty in a take-home police vehicle ($n = 78$, 8.1%). Some of the arrest cases involved officers who refused to perform field sobriety tests ($n = 81$, 8.4%) when stopped for suspicion of DUI and/or refused to consent to a blood-alcohol content (BAC) test ($n = 195$, 20.3%). Many of the police DUI arrest cases involved traffic accidents ($n = 492$, 51.2%), often resulting in victim injuries ($n = 231$, 24.1%) and fatalities ($n = 39$, 4.1%). Some of the DUI-related traffic accidents happened when an intoxicated officer flipped his or her car ($n = 33$, 3.4%) or crashed into another vehicle causing the other vehicle to flip ($n = 4$, 0.4%). Some inebriated officers fled the scene ($n = 103$, 10.7%) after being involved in a DUI-related traffic accident, and many of those officers were subsequently criminally charged with vehicular hit-and-run ($n = 76$, 7.9%). A few of the officers were involved in a DUI-related traffic accident

while attempting to flee and evade the police ($n = 10$, 1.0%). Other officers were arrested for DUI after causing a traffic accident while driving in the wrong direction on a roadway ($n = 17$, 1.8%) or denied being the driver after being involved in a DUI-related traffic accident ($n = 12$, 1.3%). Several of the traffic accidents involved an officer who was drunk while driving a motorcycle ($n = 15$, 1.6%). A few of the DUI-related traffic accidents occurred while the drunk officer was also engaged in family violence ($n = 10$, 1.0%)

Drugs in Police DUI Arrest Cases

Although there is a separate part reporting drug-related arrest cases, police DUI arrest cases that are drug-related ($n = 49$, 5.1% of the DUI cases) are reported in this section. The specific drugs involved in the drug-related DUI arrest cases are presented in Table 41. The most common drugs include “other” depressants (that is, depressants other than GHB and benzodiazepines, such as Ambien) ($n = 15$, 30.6%), oxycodone ($n = 8$, 16.3%), cocaine ($n = 5$, 10.2%), hydrocodone ($n = 4$, 8.2%), “other” narcotics (e.g., fentanyl, Demoral, methadone, Darvon, etc.) ($n = 4$, 8.2%), benzodiazepines ($n = 4$, 8.2%), amphetamine / methamphetamine ($n = 3$, 6.1%), and marijuana ($n = 3$, 6.1%). The drug-related DUI arrest cases include officers arrested for DUI while on-duty ($n = 16$, 32.7%), although the majority of the drug-related DUI cases involved an arresting agency that was not the officer’s employer ($n = 34$, 69.4%).

Predicting Conviction in Alcohol-related Police Crime Arrest Cases

The regression models in this section predict criminal conviction on one or more offenses charged against an arrested officer in alcohol-related police crime arrest cases versus nonconviction on any offense charged. Bivariate Chi-Square associations are statistically significant at $p < .05$ for 25 independent variables and the dependent variable, *conviction on any offense charged*. See Table 42. There are two bivariate associations of moderate strength as

indicated by Cramer's V scores. They are the state where the arrested officer's employing law enforcement agency is located, where $\chi^2(48, N = 654) = 95.625, p < .001, V = .382$; and victim's relationship to the arrested officer, where $\chi^2(7, N = 331) = 23.297, p = .002, V = .265$.

Table 43 presents a backward stepwise binary logistic regression model predicting conviction in alcohol-related police crime arrest cases. Bivariate correlations computed for each of the independent variables in the logistic regression model revealed that none of the variables were highly correlated with each other. Multicollinearity is not a problem as indicated by no tolerance scores below .849 and no variance inflation factors above 1.177. Autocorrelation is also not a problem as indicated by a Durbin-Watson score of 2.027. Logistic regression results indicate that the overall model of six predictors is statistically reliable in distinguishing between conviction in alcohol-related police crime arrest cases and nonconviction in alcohol-related police crime arrest cases. The model correctly classified 77.0% of the cases (AUC = .688, 95% CI [.641, .734], $R^2_{ROC} = .376$). Wald statistics indicate that all of the independent variables in the binary logistic regression model significantly predict conviction in alcohol-related police crime arrest cases.

Context for prediction of conviction in alcohol-related police crime arrest cases is provided by interpretation of odds ratios. Four of the independent variables in the model predict when conviction in alcohol-related cases is more likely than not. The simple odds of conviction in an alcohol-related arrest cases are 2.6 times greater if the arrested officer was arrested for DUI while driving a personally-owned vehicle (that is, not a police vehicle). The simple odds of conviction in alcohol-related arrest cases increase by 78.1% if the officer was arrested by a law enforcement agency that is not his or her employing agency. The simple odds of conviction in alcohol-related police crime arrest cases are two times more likely if the crime(s) for which the

officer was arrested is also sex-related. Final adverse employment outcomes also predict conviction in alcohol-related arrest cases. The simple odds of conviction in alcohol-related arrest cases are 1.5 times greater if the arrested officer ultimately loses his or her job as a sworn law enforcement officer after being arrested. Two of the independent variables in the model predict when conviction in alcohol-related police crime arrest cases is less likely to occur. The simple odds of conviction in an alcohol-related case go down by 93% if the crime(s) for which the officer was arrested involved a driving while female encounter. The simple odds of conviction in alcohol-related arrest cases goes down by 63.8% if the crime(s) for which the officer was arrested constituted officer-involved domestic violence where the officer used his or her hands or fist as a weapon.

Figure 16 presents the results of predicting conviction and included a total of 654 police crime arrest cases. The tree had an overall classification score of 76.8% (AUC = .721, 95% CI [.673, .768], $R_{ROC}^2 = .442$) and selected the variable *victim's relationship to the offender* as the splitting criterion. Cases that involved victims who were a stranger, unrelated child, ex-spouse, former boy/girlfriend, or a child/stepchild (node 1) received convictions in 77.5% of the cases. In contrast, cases that involved victims who were a current spouse, current boy/girlfriend, or relative of the offender (node 2) received convictions in 54.7% of the cases. Cases in node 1 were further partitioned by the variable *job lost*. Officers who had not lost their job were convicted in 71.3% of the cases and officers who had lost their job were convicted in 83% of the cases. Cases in node 2 were not further partitioned. The tree also included the following variables in tiers three through four: state and geographic division.

Predicting Job Loss in Alcohol-related Police Crime Arrest Cases

The next set of models predict job loss in alcohol-related police crime arrest cases. Chi-Square bivariate associations presented in Table 44 are statistically significant at $p < .05$ for 53 independent variables and the dependent variable, *job loss*. The strength of the statistically significant bivariate association is weak in 50 of the 53 predictors of job loss in alcohol-related arrest cases. There is a moderate bivariate association in the alcohol-related cases between job loss and each of the following three independent variables: the difference in years between the age of the arrested officer and the victim, where $\chi^2(67, N = 1,405) = 125.538, p < .001, V = .299$; the state where the arrested officer's employing law enforcement agency is located, where $\chi^2(50, N = 1,405) = 106.935, p < .001, V = .276$; and, victim age (categorical), where $\chi^2(9, N = 1,405) = 59.634, p < .001, V = .206$.

Table 45 presents a backward stepwise binary logistic regression model predicting job loss in the aftermath of an officer's arrest for an alcohol-related crime. Bivariate correlations computed for each of the independent variables in the logistic regression model revealed that none of the variables in the model were highly correlated with each other. None of the tolerance statistics were below .806 and none of the tolerance statistics were above 1.240. The Durbin-Watson score of 1.782 indicates that there is no autocorrelation in the model. Logistic regression results indicate that the multivariate model of seven predictors is statistically reliable in distinguishing between officers who kept their job as a sworn law enforcement officer after being arrested for an alcohol-related crime and those officers who lost their job as a sworn officer subsequent to being arrested through either voluntary resignation or involuntary termination as a final adverse employment outcome. The logistic regression model correctly classified 71.6% of the cases (AUC = .661, 95% CI [.620, .702], $R^2_{ROC} = .322$). Wald statistics indicate that all of the

independent variables in the binary logistic regression model significantly predict whether an officer will keep or lose his or her job as a sworn law enforcement officer after being arrested for an alcohol-related crime.

Context for prediction of job loss in alcohol-related police crime arrest cases is provided by interpretation of the odds ratios in the binary logistic regression model. Five of the seven independent variables in the model predict when an officer is more likely to lose his or her job as a sworn officer after being arrested for an alcohol-related crime. The simple odds of job loss in alcohol-related arrest cases are 5.5 times greater if at some point during the officer's law enforcement career, the officer was named as a party-defendant in a civil rights lawsuit that was originally filed in a state trial court and removed by the civil defendant to a United States District Court pursuant to 28 U.S.C. § 1441. If the alcohol-related crime for which an officer was arrested is also violence-related, then the simple odds of job loss are 1.4 times greater than if the officer's alcohol-related crime was not also violence-related. Similarly, the simple odds of job loss are 2.5 times greater if an officer was arrested for an alcohol-related crime that was also sex-related. Duty status also predicts job loss in alcohol-related police crime arrest cases, as the simple odds of job loss are 1.9 times greater if the officer was arrested for an alcohol-related crime that occurred while the officer was on-duty. As with many of the other prediction models, conviction predicts job loss. The simple odds of job loss in alcohol-related arrest case are 1.6 times greater if an arrested officer is ultimately convicted of at least one of the criminal offenses for which they were prosecuted in a criminal court. Two of the independent variables in the logistic regression model predict a decrease in the likelihood of job loss following an arrest for an alcohol-related police crime. If an officer was reassigned from one position to another position in the officer's employing law enforcement agency subsequent to being arrested for an

alcohol-related crime, then the simple odds of job loss decrease by 84.9%. Also, the method of crime detection predicts job loss in alcohol-related arrest cases, as the simple odds of job loss decrease by 65.1%.

Figure 17 presents the results of predicting job loss and included a total of 1,405 cases. The tree had an overall classification score of 68.3% (AUC = .710, 95% CI [.683, .738], $R_{ROC}^2 = .420$) and selected the variable *sex-related crime versus other crime type* as the splitting criterion. Officers who were not involved in a sex-related case (node 1) lost their job in 35.5% of the cases. In contrast, officers involved in a sex-related case (node 2) lost their job in 75.6% of the cases. The officers who were convicted in node 1 were partitioned by the variable *number of full-time sworn personnel*. Officers in police departments from 1-99 sworn officers lost their job in 44.7% of the cases and officers in departments from 100-1000+ sworn officers lost their job in 29.8% of the cases. The cases in node 2 were not partitioned further. The tree also included the following variables in tiers three through five: organization versus against citizenry, victim age categorical, years of service categorical, geographic division, case disposition, officer was convicted of a crime, and state.

Predicting Conviction in Police DUI Arrest Cases

This section includes regression models predicting criminal conviction in an arrest case on at least one offense charged against an officer arrested for driving under the influence (DUI). Bivariate Chi-Square associations presented in Table 46 are statistically significant at $p < .05$ for 22 independent variables and the dependent variable, *conviction on any offense charged*. The statistically significant bivariate association is strong for the State where the arrested officer's employing law enforcement agency is located, where $\chi^2(46, N = 378) = 85.253, p < .001, V = .475$. The statistically significant bivariate association is moderate for Geographic Division,

where $\chi^2 (8, N = 378) = 25.595, p = .001, V = .260$, as well as Geographic Region, where $\chi^2 (3, N = 378) = 18.376, p < .001, V = .220$. The statistically significant bivariate associations are weak for each of the other 19 independent variables and the dependent variable.

Table 47 presents a backward stepwise binary logistic regression model predicting conviction in police DUI arrest cases. Bivariate correlation computations for each of the independent variables in the model revealed that none of the variables were highly correlated with each other. None of the tolerance scores were below .936 and none of the variance inflation factors were above 1.068, indicating that multicollinearity is not a problem in the model. Autocorrelation is not a problem as indicated by the Durbin-Watson score of 2.155. Binary logistic regression results indicate that the overall model of six predictors is statistically reliable in distinguishing between conviction and nonconviction in police DUI arrest cases. The model correctly classified 81.7% of the cases (AUC = .705, 95% CI [.639, .771], $R_{ROC}^2 = .410$). Wald statistics indicate that all of the independent variables in the logistic regression model significantly predict conviction in police DUI arrest cases.

Interpretation of the odds ratios provide context for prediction of conviction in police DUI arrest cases. Two of the independent variables in the logistic regression model predict when conviction is more likely than not in police DUI cases. The simple odds of conviction are 1.3 times greater if the arrested officer was involved in a DUI-related traffic accident resulting in his or her arrest. Once again, job loss predicts conviction, as the simple odds of conviction are 1.4 times greater if the arrested officer ultimately loses his or her job as a final adverse employment action in the aftermath of being arrested for DUI. The four other independent variables in the model predict when criminal conviction in a police DUI arrest case is less likely to occur. If an officer arrested for DUI was also charged with a liquor law violation, then the simple odds of

conviction on at least one criminal offense charged decreased by 94.5%. The simple odds of conviction decreased by 61.3% if the officer was acting in his or her official capacity as a sworn law enforcement officer when arrested for DUI. In cases where an officer denied driving after being involved in a DUI-related traffic accident, the simple odds of conviction decreased by 94.3%. In some instances, officers who were arrested for DUI refused to submit to a blood-alcohol content (BAC) test. The simple odds of conviction decreased by 53.9% when an officer arrested for DUI refused to submit to a BAC test.

Figure 18 presents the results of predicting conviction and included a total of 390 cases. The tree had an overall classification score of 80.3% (AUC = .747, 95% CI [.684 .809], $R_{ROC}^2 = .494$) and selected the variable *geographic division* as the splitting criterion. Cases from East North Central, West North Central, and East South Central geographic divisions (node 1) had convictions in 92.6% of the cases. In contrast, cases from New England, South Atlantic, Pacific, Middle Atlantic, Mountain, and West South Central divisions (node 2) had convictions in 72.6% of the cases. The cases in node 1 were not partitioned further. The cases in node 2 were partitioned by the variable *state*. Cases in Massachusetts, Florida, South Carolina, North Carolina, Pennsylvania, Rhode Island, Washington, Texas, New Hampshire, Oregon, New Mexico, Connecticut, and Montana had convictions in 55.7% of the cases. Cases in California, New York, New Jersey, Virginia, West Virginia, Colorado, Arkansas, Nevada, Maryland, Georgia, Maine, Arizona, Idaho, Utah, Oklahoma, Hawaii, Delaware, Vermont, and the District of Columbia had convictions in 88.1% of the cases. The tree did not have any additional variables.

Predicting Job Loss in Police DUI Arrest Cases

The next set of models predict job loss in police DUI arrest cases. Chi-Square bivariate associations presented in Table 48 are statistically significant at the $p < .05$ level for 29 independent variables and the dependent variable, *job loss*. There is a moderate bivariate association between job loss and each of the following three independent variables: the State in which the arrested officer's employing law enforcement agency is located, where $\chi^2 (50, N = 960) = 107.344, p < .001, V = .334$; the difference in years between the age of the arrested officer and the age of the victim, where $\chi^2 (54, N = 960) = 80.423, p = .011, V = .289$; and, Geographic division, where $\chi^2 (8, N = 960) = 38.273, p < .001, V = .200$.

A backward stepwise binary logistic regression model predicting job loss in police DUI arrest cases is presented in Table 49. Bivariate correlations computed for each of the independent variables in the logistic regression model revealed that none of the variables in the model were highly correlated with each other. None of the tolerance scores were below .841 and none of the tolerance scores were above 1.190, indicating that multicollinearity is not a problem. The Durbin-Watson score of 1.975 indicates that there is no autocorrelation in the model. Binary logistic regression results indicate that the multivariate model of eight predictors is statistically reliable in distinguishing between officers who kept their jobs and officers who lost their jobs after being arrested for DUI. The logistic regression model only correctly classified 66.9% of the cases (AUC = .718, 95% CI [.666, .770], $R_{ROC}^2 = .436$). Wald statistics indicate that all of the independent variables in the logistic regression model significantly predict whether an officer will keep or lose his or her job after being arrested for DUI.

Interpretation of odds ratios provides context for prediction of job loss as a final adverse employment action against an officer after being arrested for DUI. Six of the independent

variables in the logistic regression model predict when an officer is more likely than not to lose his or her job after being arrested for DUI. The simple odds of job loss are 7.5 times greater if an officer was involved in a DUI-related traffic accident after driving in the wrong direction on a roadway. If an officer was charged with murder or nonnegligent manslaughter in a DUI arrest case, the simple odds of job loss are 2.5 times greater. The simple odds of job loss are 1.9 times greater if the officer was acting in his or her official capacity when arrested for DUI. If the DUI arrest case incident was also violence-related, then the simple odds of job loss are 1.4 times greater. Here again, conviction predicts job loss, as the simple odds of job loss are 1.3 times greater if an officer arrested for DUI was ultimately convicted of one or more criminal offenses arising out of the incident. Experienced police officers are more likely to lose their jobs after being arrested for DUI than are inexperienced officers, as the simple odds of job loss increased by 4.3% for every one unit categorical (3 year) increase in years of service at time of arrest. Two of the independent variables in the logistic regression model predict when job loss is less likely to occur subsequent to an officer's arrest for DUI. The simple odds of job loss decreased by 13.8% for every one unit categorical increase in the number of full-time sworn personal employed by the arrested officer's employing law enforcement agency. Some law enforcement agencies require their officers to be available at all times, 24/7. The simple odds of job loss subsequent to an officer's off-duty DUI arrest decreased by 89.5% if the officer's employing agency requires 24/7 availability.

Figure 19 presents the results of predicting job loss and included a total of 991 arrest cases. The tree had an overall classification score of 70.7% (AUC = .679, 95% CI [.642, .715], $R^2_{ROC} = .358$) and selected the variable *geographic division* as the splitting criterion. Officers from New England, West North Central, South Atlantic, and Mountain division states (node 1)

lost their job in 41.8% of the cases. In contrast, officers from East North Central, Pacific, Middle Atlantic, West South Central, and East South Central divisions (node 2) lost their job in 25.7% of the cases. Cases in node 1 were partitioned by the variable *state*. Officers from Minnesota, Connecticut, Rhode Island, West Virginia, Montana, Nevada, North Dakota, Maryland, Wyoming, Maine, Iowa, Kansas, Delaware, Idaho, and Nebraska lost their job in 19.8% of the cases. Officers from Massachusetts, Florida, South Carolina, Colorado, Georgia, New Mexico, North Carolina, Virginia, Arizona, South Dakota, New Hampshire, Missouri, District of Columbia, Utah, and Vermont lost their job in 48.5% of the cases. Cases in node 2 were partitioned by the variable *state*. Officers from; Illinois, Texas, Michigan, Tennessee, Pennsylvania, Oklahoma, and Alabama lost their job in 37.4% of the cases. Officers from Ohio, Indiana, California, New York, Louisiana, Wisconsin, New Jersey, Kentucky, Washington, Arkansas, Oregon, Mississippi, Alaska, and Hawaii lost their job in 18.4% of the cases. The tree also included the following variables in tiers three through five: age (categorical) and state.

Part IV: Drug-related Police Crime Data Set Models

The data set includes 739 cases in which sworn law enforcement officers were arrested for drug-related crimes during the time period January 1, 2005, through December 31, 2011. The drug-related arrest cases involve 665 individual sworn officers employed by 432 nonfederal state, local, special, constable, and tribal law enforcement agencies located in 323 counties and independent cities in 45 states and the District of Columbia (all except Alaska, Maine, Montana, North Dakota, and Vermont). Of these, 44 (6.6%) of the arrested officers have more than one case ($\bar{X} = 1.11$, $Mdn = 1.00$, $Mode = 1$, $SD = .724$) because they have more than one victim (one criminal case per crime victim) and/or were arrested for a drug-related crime on more than one occasion.

The majority of drug-related arrest cases involved an officer who is known to have ultimately lost their job ($n = 520$, 70.4%) as a sworn law enforcement officer as a result of being arrested. The known final employment outcomes in the drug-related cases include those in which there was no known adverse employment action ($n = 64$, 8.7%), where the officer was suspended ($n = 155$, 21.0%) for a period of time, where the officer was separated through voluntary resignation ($n = 220$, 29.8%), and those cases where the officer was separated through involuntary termination ($n = 300$, 40.6%). Approximately two-thirds of the drug-related police crime arrest cases resulted in a criminal conviction against the arrested officer ($n = 485$, 65.6%) on at least one offense.

Officers Arrested for Drug-related Police Crime, Offenses Charged & Employing Agencies

Table 50 presents information on the drug-related arrest cases in terms of the arrested officers and their employing nonfederal law enforcement agencies. Most of the drug-related cases involve male officers ($n = 701$, 94.9%). The modal category for known officer age at time

of arrest is 36-39 years of age ($n = 136$, 18.4%). The youngest officer was age 20 at time of arrest, and the oldest officer was 76 years old (\bar{X} age = 37.18, Mdn age = 36, Mode age = 28, $SD = 8.182$ years). The modal category for known years of service at time of arrest is three to five years ($n = 116$, 15.7%). Most of the drug-related arrest cases involve sworn officers employed in patrol or street-level rank including nonsupervisory officers, deputies, troopers, and detectives ($n = 629$, 85.1%). Other drug-related cases involve arrested line and field supervisors ($n = 74$, 10.0%) (i.e., corporals, sergeants, and lieutenants), as well as police executives and managers ($n = 36$, 4.9%) (i.e., captains, majors, deputy chiefs and chief deputies, and chiefs and sheriffs). Well over half of the drug-related arrest cases involve crimes that were committed while on-duty ($n = 444$, 60.1%) working in official capacity as a sworn officer. Many of the drug-related cases ($n = 527$, 71.3%) involve an officer who was arrested by a law enforcement agency other than the arrested officer's employing nonfederal law enforcement agency.

Most of the drug-related arrest cases involve sworn officers employed by municipal police departments ($n = 527$, 71.3%) or sheriff's offices ($n = 139$, 18.8%). Officers arrested for drug-related crimes were also employed by primary state police agencies ($n = 23$, 3.1%), county police departments ($n = 25$, 3.4%), special law enforcement agencies ($n = 20$, 2.7%), constable agencies ($n = 4$, 0.5%), and a tribal police department ($n = 1$, 0.1%). The modal category for agency size by number of sworn officers employed is 1,000 or more full-time sworn officers ($n = 236$, 31.9%) and zero part-time sworn officers ($n = 551$, 74.6%). Most of the officers arrested in drug-related criminal cases were employed by a law enforcement agency located in a nonrural metropolitan county or independent city ($n = 611$, 82.7%). The employing law enforcement agencies are located throughout the United States, including in the Southern states ($n = 346$,

46.8%), Northeastern states ($n = 154$, 20.8%), Midwestern states ($n = 145$, 19.6%), and Western states ($n = 94$, 12.7%).

Table 51 presents the drug-related cases in terms of the most serious offense charged. There are 37 separate offense categories represented as the most serious offense charged in drug-related police crime arrest cases during the years 2005-2011. Most common in the drug-related cases as the most serious offense charged are drug offenses ($n = 308$, 41.7%), robbery ($n = 60$, 8.1%), driving under the influence ($n = 38$, 5.1%), unclassified theft/larceny offenses ($n = 33$, 4.5%), theft from a building ($n = 28$, 3.8%), and burglary ($n = 26$, 3.5%).

Specific Drugs and Classes of Drugs in the Drug-related Police Crime Arrest Cases

Table 52 presents information on the specific drugs as well as classes of drugs in the drug-related police crime arrest cases from years 2005-2011. In some cases it was not possible to determine specific drugs, or even classes of drugs, involved in the criminal behavior resulting in an officer's arrest for a drug-related crime. All classes of commonly abused drugs are found, except inhalants, in the drug-related police crime arrest cases, including stimulants ($n = 308$, 41.7%), narcotics, ($n = 197$, 26.7%), cannabis ($n = 177$, 24.0%), depressants ($n = 45$, 6.1%), anabolic steroids ($n = 44$, 5.9%), and hallucinogens ($n = 23$, 3.1%). Some of the drug-related arrest cases involve two classes of drugs ($n = 105$, 14.2%), three classes of drugs ($n = 22$, 3.0%), or four classes of drugs ($n = 13$, 1.8%).

Twenty specific drugs were mentioned in the case article narratives and/or court records of drug-related arrest cases analyzed in the current study. The most common drugs in these cases are cocaine ($n = 233$, 31.5%), marijuana ($n = 177$, 24.0%), oxycodone ($n = 89$, 12.0%), hydrocodone ($n = 69$, 9.3%), crack ($n = 58$, 7.8%), amphetamine and methamphetamine ($n = 53$, 7.2%), heroin ($n = 50$, 6.8%), unclassified narcotics ($n = 29$, 3.9%), anabolic steroids not

including testosterone ($n = 29$, 3.9%), unclassified depressants ($n = 26$, 3.5%), benzodiazepines ($n = 19$, 2.6%), and testosterone ($n = 17$, 2.3%). Some of the drug-related arrest cases involve four or more specific drugs ($n = 22$, 3.0%), three specific drugs ($n = 35$, 4.7%), two specific drugs ($n = 136$, 18.4%), or one specific drug ($n = 415$, 56.2%). In some drug-related cases it was not possible to determine any specific drug ($n = 131$, 17.7%).

Victims of Drug-related Police Crime

Victim characteristics in drug-related police crime arrest cases in years 2005-2011 are presented in Table 53. Victim information was not ascertainable in many of the drug-related police crime arrest cases. As such, missing data limits the findings as to victims of the drug-related cases. Over half of the known victims of drug-related police crime are male ($n = 57$, 52.3%). The modal category for known victim age is 20-24 ($n = 8$). Most of the known victims were adults ($n = 129$, 90.2%) and almost none of the victims of drug-related police crime were also known to be police officers ($n = 4$, 2.9%). The relationship of the victim and the arrested officer could not be determined in most of the drug-related arrest cases ($n = 601$, 81.3%). Of known victims, most are strangers or nonstranger acquaintances ($n = 112$, 81.2%) to the arrested officer.

Predicting Patterns of Drug-related Corruption in Police Crime Arrest Cases

Table 54 presents patterns of drug-related corruption in police crime arrest cases during the years 2005-2011. The arrested officers were charged with drug-related crimes that involved a variety of recognized patterns of drug corruption, including drug trafficking ($n = 299$, 40.5%), personal use of drugs ($n = 235$, 31.8%), crimes that facilitate the drug trade ($n = 172$, 23.3%), drug-related shakedowns and thefts ($n = 171$, 23.1%), drug thefts from police evidence rooms ($n = 60$, 8.1%), drug-related falsification ($n = 58$, 7.8%), forged prescriptions ($n = 33$, 4.5%),

planting evidence ($n = 33$, 4.5%), and crimes that involve sexually-motivated drug corruption ($n = 25$, 3.4%). Drug-related shakedowns included thefts from street-level drug dealers ($n = 75$), thefts during warrantless searches ($n = 69$), thefts during traffic stops of cars and from drug couriers ($n = 58$), off-duty robberies ($n = 35$), illegitimate raids and searches ($n = 33$), and shakedowns and thefts during dispatched calls for service ($n = 16$). Some of the drug-related police crime arrest cases did not involve any patterns of drug corruption ($n = 59$, 8.0%). The largest number of the drug-related cases included one pattern ($n = 316$, 42.8%) or two patterns ($n = 192$, 26.0%) of drug corruption. A smaller percentage of the cases involved three patterns ($n = 72$, 9.7%), four patterns ($n = 56$, 7.6%), or five or more patterns ($n = 44$, 5.9%) of drug corruption criminal activities.

Some of the drug-related police crime arrest cases also involved other types of police crime, including those that are also profit-motivated ($n = 438$, 59.3%), violence-related ($n = 132$, 17.9%), alcohol-related ($n = 38$, 5.1%), and/or sex-related ($n = 37$, 5.0%). Many of the drug-related police crime arrest cases also involve at least one other type of police crime ($n = 513$, 69.4%).

CART procedures were utilized to identify the causal pathways between the statistically significant variables to create classification estimates for six of the most prevalent forms of misconduct including drug trafficking, the three most prevalent types of theft/shakedown, drug use, and facilitation of the drug trade. Cocaine was the strongest predictor for three of the six decision trees where specific drugs were the independent variables. The CART analysis also identified numerous other drugs that all significantly contributed to classification estimates beyond the splitting criterion. The following drugs were represented in nodes below the splitting criterion: hydrocodone, heroin, marijuana, crack, anabolic steroids (other than testosterone),

phencyclidine and analogs, oxycodone, and cocaine. The CART models presented in Table 55 had varying levels of predictive power AUC of .685 to .792. The models that examined drug trafficking and facilitation of the drug trade had poor predictive power. In contrast, the models that examined various forms of theft/shakedown had the highest levels of predictive power. The tree predicting theft/shakedowns of street level dealers had the highest predictive power (AUC = .792, 95% CI [.740, .844], $R^2_{ROC} = .584$). Cocaine was identified as the strongest predictor and, therefore, was selected as the splitting criterion for the data. The remaining branches of the tree were based on the responses to the splitting criterion. Marijuana and heroin were statistically significant, but only in cases where cocaine was present.

A second set of decision tree analyses predicted the various patterns of corruption using drug classes instead of specific drugs is also presented in Table 55. Stimulants were selected as the splitting criterion, and were the strongest predictor for facilitation of the drug trade, drug trafficking, and shakedowns and thefts from car stops and drug couriers. Narcotics were the strongest predictor for drug use. Cannabis were the strong predictor for shakedowns and thefts from warrantless searches/seizures and street level dealers. CART trees that utilized drug classes as predictors had a large range of predicted power. The tree predicting facilitation of the drug trade had a low AUC score of .654, suggesting that the tree is barely able to predict 50% of the cases correctly. The trees predicting the specific types of shakedowns each have AUC scores that exceed 0.75. The strongest tree predicted thefts/shakedowns from street-level dealers based on cannabis as the strongest predictor and splitting variable (AUC = .755, 95% CI [.697, .814], $R^2_{ROC} = .510$).

Predicting Conviction in Drug-related Police Crime Arrest Cases

The regression models in this section predict criminal conviction on one or more offenses charged in drug-related police crime arrest cases versus nonconviction on any offense.

Conviction data are available on approximately three-fourths of the drug-related cases ($n = 562$, 76.0%). Of those, most of the officers arrested in a drug-related case were convicted ($n = 485$, valid 86.3%) on at least one criminal offense charged in the case. Bivariate Chi-Square associations are statistically significant at the $p < .05$ level for 28 independent variables and the dependent variable, *conviction on any offense charged*. See Table 56. There are four bivariate moderate associations as indicated by the Cramer's V scores for the statistically significant Chi-Square statistics. They are victim relationship to the arrested officer, where $\chi^2(6, N = 129) = 15.398, p = .017, V = .345$; the state where the arrested officer's employing agency is located, where $\chi^2(43, N = 562) = 65.220, p = .016, V = .341$; the number of years difference in age between the arrested officer's age at time of arrest and the age of their victim, where $\chi^2(25, N = 562) = 63.847, p < .001, V = .337$; and, the age of the victim (in a categorical age recoded variable), where $\chi^2(9, N = 562) = 47.832, p < .001, V = .292$.

Table 57 presents a backward stepwise binary logistic regression model predicting conviction in drug-related police crime arrest cases. Bivariate correlations computed for each of the independent variables in the logistic regression model revealed that none of the variables were highly correlated with each other. Multicollinearity is not a problem as indicated by no tolerance scores below .928 and no variance inflation factors above 1.077. Autocorrelation is also not a problem as indicated by a Durbin-Watson score of 1.799. Logistic regression results indicate that the overall model of five predictors is statistically reliable in distinguishing between conviction in drug-related police crime arrest cases and nonconviction in drug-related police

crime arrest cases. The model correctly classified 85.3% of the cases (AUC = .849, 95% CI [.761, .937], $R^2_{ROC} = .698$). Wald statistics indicate that all of the independent variables in the binary logistic regression model significantly predict conviction in drug-related police crime arrest cases.

Odds ratio interpretations provide context for prediction of conviction on one or more criminal offenses charged in drug-related police crime arrest cases. The simple odds of conviction are 3.5 times greater if the officer ultimately loses their job as a sworn law enforcement officer subsequent to an arrest for a drug-related crime. Conversely, the simple odds of conviction decrease by 87.3% if the officer was suspended from their job as a sworn law enforcement officer after being arrested in a drug-related criminal case. If an officer is charged with obstruction of justice in a drug-related criminal case, the simple odds of conviction decrease by 81.8%. It is possible in drug-related cases where an officer is charged with obstruction of justice that criminal courts are skeptical of the officer's criminality.

The relationship of the victim in a drug-related police crime arrest case also impacts on whether an arrested officer will be convicted of at least one criminal offense charged in the case. The simple odds of conviction increase by 60.1% for every one step increase in our categorical variable of victim relationship. In that eight-category variable, 1 = *victim is current spouse of the arrested officer*, and 8 = *stranger or nonstranger acquaintance to the arrested officer*. Thus, an officer is more likely to be convicted in a drug-related police crime arrest case the more distant the relationship is between the arrested officer and their victim in a drug-related crime. The simple odds of conviction decrease by 9.1% for every one step increase in the categorical age of the victim in a drug-related police crime arrest case. That is to say, generally, as victim age goes

up, the likelihood of conviction of one or more criminal offenses charged in a drug-related police crime case goes down.

Figure 20 presents the results of predicting conviction and included a total of 562 arrest cases. The tree had an overall classification score of 86.3% (AUC = .760, 95% CI [.703, .816], $R^2_{ROC} = .520$) and selected the variable *officer was suspended* as the splitting criterion. Officers who had been previously suspended (node 1) were convicted in 80.9% of the cases. In contrast, officers who were not previously suspended (node 2) were convicted in 48.9% of the cases. The officers who had been previously suspended in node 1 were partitioned by the variable *job loss*. Officers who lost their job were convicted in 85.7% of the cases and officers who did not lose their job were suspended in only in 67.9% of the cases. The officers who had not been previously suspended in node 2 were partitioned by the variable *profit-motivated police crime versus other crime*. Officers who were involved in a profit-motivated case were convicted in 96.4% of the cases and officers who were not involved in a profit-motivated case were convicted in 86.1% of cases. The tree also included the following variables in tiers two through four: stimulants, arresting agency, drug/narcotic violation, and drugs: selling, dealing, or trafficking.

Predicting Job Loss in Drug-related Police Crime Arrest Cases

In this section, the models predict job loss in the drug-related police crime arrest cases. More than two-thirds of drug-related arrest cases are known to have resulted in the arrested officer losing his or her job ($n = 520$, 70.4%) as a sworn law enforcement officer subsequent to being arrested. Chi-Square bivariate associations are statistically significant at the $p < .05$ level for 41 independent variables and the dependent variable, *job loss*. See Table 58. The strength of the statistically significant bivariate association is, however, weak in 38 of the 41 predictors. There is a moderate association that is statistically significant between job loss and officer's age

at time of arrest, where $\chi^2(45, N = 739) = 62.818, p = .041, V = .303$; year of officer's arrest (during the study period of officers who were arrested during the years 2005 through 2011), where $\chi^2(6, N = 739) = 56.885, p < .001, V = .277$; and, difference in years between the age of the arrested officer at time of arrest and the age of the victim in a drug-related police crime arrest case, where $\chi^2(26, N = 739) = 39.386, p = .045, V = .231$.

Table 59 presents a backward stepwise binary logistic regression model predicting job loss subsequent to an officer's arrest for a drug-related crime. Bivariate correlations computed for each of the independent variables in the logistic regression model revealed that none of the variables in the model were highly correlated with each other. None of the tolerance statistics are below .892, and none of the variance inflation factors are higher than 1.121, indicating that multicollinearity is not a problem. The Durbin-Watson score of 1.791 indicates that there is no autocorrelation in the model. Logistic regression results indicate that the multivariate model of nine predictors is statistically reliable in distinguishing between officers who kept their job after being arrested for a drug-related crime and officers who lost their jobs after being arrested through either involuntary termination or voluntary resignation. The model correctly classified 78.7% of the cases (AUC = .817, 95% CI [.776, .859], $R^2_{ROC} = .634$). Wald statistics indicate that all of the independent variables in the model significantly predict whether an officer lost or kept their job as a sworn law enforcement officer after being arrested for a drug-related police crime.

Predictors of the final adverse employment outcomes in the drug-related police crime arrest cases are aided by interpretation of the odds ratios. Five of the independent variables predict when an officer is more likely to lose his or her job as a sworn law enforcement officer after being arrested for a drug-related crime. The simple odds of job loss are 5.6 times greater if the arrested officer has been sued (at some point during their law enforcement career) in a state

court for civil rights violations and the civil action was removed from state court to a federal district court pursuant to 28 U.S.C. §1441 because the lawsuit raised a federal question. These are cases where a cause of action arose under 42 U.S.C. §1983 (civil action for deprivation of civil rights under the color of law) that were originally filed in a state trial court and later removed by defense counsel to a United States District Court because the claim involves a federal statute or constitutional tort. Almost one-third of the drug-related police crime arrest cases ($n = 232$, 31.4%) involve an officer who has been sued in federal court pursuant to 42 U.S.C. §1983 at some point during their police career. The class of drug involved in the arrest case also impacts on the final adverse employment outcome (job loss). The simple odds of job loss are almost 3.3 times greater if the drug-related police crime arrest case involved a narcotic. Also, the level of rurality in the location of the arrested officer's employer predicts job loss. The simple odds of job loss after being arrested for a drug-related police crime are approximately 1.6 times greater if the employing law enforcement agency is located in a nonmetropolitan (that is, rural) county or independent city.

Four of the independent variables in the logistic regression model predict when an officer is more likely to keep his or her job subsequent to being arrested for a drug-related police crime. The simple odds of job loss decrease by 73.8% if the drug-related crime is also alcohol-related. Certain crimes predict a decrease in likelihood of job loss following an officer's arrest for a drug-related crime. The simple odds of job loss decrease by 82.1% if the officer is charged with counterfeiting and/or forgery offenses. Similarly, the simple odds of job loss decrease by 69.4% if the drug-related police crime case includes an allegation of falsification by the arrested officer. If the arrested officer's chief is under scrutiny as a result of the drug-related police crime case, then the simple odds of job loss for the arrested officer go down by 62.8%.

Figure 21 presents the results of predicting job loss and included a total of 739 arrest cases. The tree had an overall classification score of 71.3% (AUC = .733, 95% CI [.695, .770], $R^2_{ROC} = .466$) and selected the variable *year of arrest* as the splitting criterion. Officers who were arrested before the year 2007 (node 1) lost their job in 54.0% of the cases. In contrast, officers who were arrested after 2007 (node 2) lost their job in 78.7% of the cases. The officers arrested prior to the year 2007 in node 1 were not partitioned by any variable. The officers arrested after the year 2007 in node 2 were partitioned by the variable *criminal conviction*. Officers who were convicted lost their jobs in 81.1% of the cases and officers who were not convicted lost their job in 57.4% of cases. The tree also included the following variables in tiers three through six: profit-motivated crime versus other crime type, officer was suspended for a period of time, year of arrest, and age.

Part V: Violence-related Police Crime Data Set Models

There are 3,328 cases in the data set where nonfederal sworn law enforcement officers were arrested for violence-related crimes during the years 2005-2011. The violence-related arrest cases involve 2,586 individual officers employed by 1,445 nonfederal state, local, special, constable, tribal, and regional law enforcement agencies located in 805 counties and independent cities in 49 states (all except Wyoming) and the District of Columbia. Of those, 407 of the arrested officers had more than one case ($\bar{X} = 1.29$, $Mdn = 1.00$, $Mode = 1$, $SD = 1.044$), because they had more than one victim (one criminal case per victim) and/or were arrested for a violence-related crime on more than one occasion during the study period years of 2005-2011.

More than half of the violence-related arrest cases involve an officer who is known to have lost his or her job ($n = 1,748$, 52.5%) subsequent to being arrested. The known final employment outcomes in the violence-related arrest cases include those in which there was no known adverse employment action taken against the arrested officer ($n = 419$, 12.6%), cases resulting in the arrested officer being suspended from his or her job for a period of time ($n = 1,161$, 34.9%), cases in which the arrested officer was separated through voluntary resignation ($n = 767$, 23.0%), and cases in which the arrested officer was separated through involuntary termination of employment ($n = 981$, 29.5%). Less than half of the violence-related arrest cases are known to have resulted in criminal conviction of the arrested officer ($n = 1,316$, 39.5%) on at least one criminal offense, although the conviction rate is higher (66.3%) in the cases where the criminal case disposition is known.

Included in the violence-related police crime cases are a subset of 961 officer-involved domestic violence arrest cases. The officer-involved domestic violence cases involve 849 individual officers employed by 604 nonfederal state, local, special, tribal, and regional law

enforcement agencies located in 436 counties and independent cities in 49 states (all except Wyoming) and the District of Columbia. Of these, 89 of the arrested officer had more than one officer-involved domestic violence arrest case ($\bar{X} = 1.13$, $Mdn = 1.00$, $Mode = 1$, $SD = .449$), because they had more than one victim and/or were arrested for a crime involving officer-involved domestic violence (while still employed as a sworn law enforcement officer) on more than one occasion during the years 2005-2011.

Just over one-third of the officer-involved domestic violence arrest cases involve an officer known to have lost his or her job ($n = 360$, 37.5%) as a sworn law enforcement officer after being arrested. The known final employment outcomes in the officer-involved domestic violence arrest cases include those in which there was no known adverse employment action taken against the arrested officer ($n = 148$, 15.4%), cases that resulted in the arrested officer being suspended from his or her job for a period of time ($n = 453$, 47.1%), cases in which the arrested officer was separated from his or her employing law enforcement agency through voluntary resignation ($n = 150$, 15.6%), and cases in which the arrested officer was separated through involuntary termination of employment ($n = 210$, 21.9%).

Officers Arrested for Violence-related Police Crime, Offenses Charged & Employers

Table 60 presents information on the violence-related police crime arrest cases in terms of the arrested officers and their employing law enforcement agencies. Most of the violence-related cases involve male officers ($n = 3,194$, 96.0%) who were arrested. The youngest officer arrested for a violence-related crime was age 19 at time of arrest, and the oldest officer was 74 years old (\bar{X} age = 36.00, Mdn age = 36.00, $Mode$ age = 35, $SD = 8.232$ years). Most of the violence-related arrest cases involve sworn officers employed in patrol or street-level nonsupervisory positions ($n = 2,797$, 84.0%). Less than two-thirds of the violence-related police

crime arrest cases involved crimes committed while the officer was off-duty ($n = 2,155$, 64.8%). Similarly, less than two-thirds of the violence-related arrest cases involve arrests effectuated by some other law enforcement agency ($n = 2,100$, 63.1%) and were not arrested by representatives of the agency where the arrested officer was employed.

Most of the violence-related police crime arrest cases involved officers employed by municipal police departments ($n = 2,504$, 75.2%) or sheriff's offices ($n = 523$, 15.7%). Officers arrested for violence-related crimes were also employed by primary state police agencies ($n = 118$, 3.5%), county police departments ($n = 90$, 2.7%), special police departments ($n = 77$, 2.3%), constable agencies ($n = 6$, 0.2%), tribal police departments ($n = 9$, 0.3%), or a regional police department ($n = 1$, 0.0%). The modal category for agency size by number of full-time sworn personnel is 1,000 or more sworn officers ($n = 987$, 29.7%). Most of the employing law enforcement agencies were located in a nonrural metropolitan county or independent city ($n = 2,880$, 86.5%). The agencies employing officers arrested for violence-related police crime are located throughout the United States, including in Southern states ($n = 1,386$, 41.6%), Northeastern states ($n = 715$, 21.5%), Midwestern states ($n = 664$, 20.0%), and Western states ($n = 563$, 16.9%).

Table 61 presents the violence-related police crime arrest cases in terms of the most serious offense charged. There are 40 separate criminal offense categories representing the most serious offense charged in each of the violence-related cases during the years 2005-2011. Most common offenses are simple assault ($n = 870$, 26.4%), aggravated assault ($n = 570$, 17.1%), forcible fondling ($n = 352$, 10.6%), forcible rape ($n = 322$, 9.7%), intimidation and harassment ($n = 200$, 6.0%), murder and nonnegligent manslaughter ($n = 104$, 3.1%), unclassified offenses ($n =$

99, 3.0%), forcible sodomy ($n = 94$, 2.8%), robbery ($n = 92$, 2.8%), and criminal deprivation of civil rights ($n = 61$, 1.8%).

Victims of Violence-related Police Crime

Table 62 presents victim characteristics in violence-related police crime arrest cases during the years 2005-2011. More than half of the cases involve a crime victim who is female ($n = 1,841$, 55.3%, known 62.1%). Most of the victims are adults ($n = 2,416$, 72.6%, known 78.1%) and are not law enforcement officers ($n = 2,912$, 87.5%, known 93.8%). Slightly more than half of the victims are strangers or nonstranger acquaintances ($n = 1,668$, 50.1%, valid 54.3%) to the officer who was arrested. Some of the victims of violence-related police crime arrest cases were family members of the arrested officer, including current spouse ($n = 336$, 10.1%), former spouse ($n = 59$, 1.8%), child or stepchild ($n = 159$, 4.8%), or some other relative ($n = 84$, 2.5%). Other victims include a child unrelated to the arrested officer ($n = 451$, 13.6%), current girlfriend or boyfriend ($n = 195$, 5.9%) and former girlfriend or boyfriend ($n = 118$, 3.5%).

Predicting Conviction in Violence-related Police Crime Arrest Cases

In this section the regression models predict conviction in violence-related police crime arrest cases. Bivariate Chi-Square associations presented in Table 63 are statistically significant at $p < .05$ for 75 independent variables and the dependent variable, *conviction on any offense charged*. Five of the bivariate associations are of moderate strength as indicated by the Cramer's V score, including job loss, where $\chi^2(1, N = 1,984) = 254.985, p < .001, V = .358$; victim age, where $\chi^2(73, N = 962) = 96.014, p = .037, V = .316$; the State in which the arrested officer's employing law enforcement agency is located, where $\chi^2(49, N = 1,984) = 98.550, p < .001, V =$

.223; sex-related, where $\chi^2(1, N = 1,984) = 85.756, p < .001, V = .208$; and, the relationship of the victim to the arrested officer, where $\chi^2(7, N = 1,855) = 77.089, p < .001, V = .204$.

Table 64 presents a backward stepwise binary logistic regression model predicting conviction in violence-related police crime arrest cases. Computation of bivariate correlations for each of the independent variables in the model revealed that none of the variables were highly correlated with each other. Multicollinearity is not a problem as indicated by no tolerance scores below .779 and no variance inflation factors above 1.285. The Durbin-Watson score of 1.748 indicates that autocorrelation is not a problem. Logistic regression results indicate that the overall model of ten predictors is statistically reliable in distinguishing between conviction and nonconviction in violence-related police crime arrest cases. The binary logistic regression model correctly classified 77.1% of the cases (AUC = .741, 95% CI [.718, .764], $R^2_{ROC} = .482$). Wald statistics indicate that all of the independent variables in the model significantly predict criminal conviction in violence-related police crime arrest cases.

Interpretation of the odds ratios in the logistic regression model provide context for prediction of conviction in violence-related police crime arrest cases. Nine of the independent variables in the regression model predict when conviction is more likely to occur when an officer was charged with one or more violence-related criminal offenses. The serious nature of the crimes for which officers were arrested impacts on criminal conviction. The simple odds of conviction are more than 11 times greater if the arrested officer was charged with either burglary or driving under the influence while driving a personally-owned vehicle. Similarly, the simple odds of conviction are eight times greater if the officer was arrested for pornography or obscene material. The simple odds of conviction in violence-related police crime arrest cases are 2.9 times greater if the officer was arrested for criminal deprivation of civil rights, and 1.7 times

greater if the arrested officer was charged with forcible sodomy. If the violence-related crime for which an officer was arrested is also sex-related, then the simple odds of conviction are 87% more likely than if the crime was not sex-related. Also, the level of an officer's experience as a sworn law enforcement officer predicts conviction because it is a factor considered by the courts in criminal case adjudication. The simple odds of conviction in violence-related cases go up by 4.9% for every one unit categorical (three year) increase in years of service as a sworn officer at time of the officer's arrest. The simple odds of conviction in violence-related police crime arrest cases are 6.3 times greater if the underlying incident was officer-involved domestic violence resulting in fatal injuries to the victim. As with most other prediction models in this study, job loss predicts criminal conviction, as the simple odds of conviction in violence-related police crime arrest cases is 4.5 times greater if the officer ultimately lost his or her job as a sworn law enforcement officer after being arrested. There is one independent variable in the logistic regression model that predicts when the odds of criminal conviction decrease; the simple odds of conviction in violence-related cases decrease by 8.3% for every one categorical unit increase in the number of full-time sworn personnel employed by the arrested officer's employing law enforcement agency. The odds of conviction in violence-related police crime arrest cases go down as the size of the arrested officer's employing agency goes up.

Figure 22 presents the results of predicting conviction and included a total of 654 police officers. The tree had an overall classification score of 76.8% (AUC = .721, 95% CI [.673, .768], $R^2_{ROC} = .442$) and selected the variable *victim's relationship to the offender* as the splitting criterion. Cases that involved victims who were a stranger or nonstranger acquaintance, unrelated child, ex-spouse, former boyfriend or girlfriend, or a child/stepchild (node 1) to the offender resulted in a conviction in 77.5% of the cases. In contrast, cases that involved victims

who were a current spouse, current boyfriend or girlfriend, or some other relative of the offender (node 2) resulted in a conviction in 54.7% of the cases. Cases in node 1 were further partitioned by the variable *job loss*. Officers who lost their job were convicted in 83% of the cases and officers who did not lose their job were convicted in only in 71.3% of the cases. Cases in node 2 were not partitioned further. The tree also included the following variables in tiers two through four: geographic region and state.

Predicting Job Loss in Violence-related Police Crime Arrest Cases

The next set of regression models predict job loss in violence-related police crime arrest cases. Chi-Square bivariate associations presented in Table 65 are statistically significant at $p < .05$ for 90 independent variables and the dependent variable, *job loss*. The strength of the statistically significant bivariate associations is moderate for each of 8 independent variables and job loss: conviction, where $\chi^2(1, N = 1,984) = 254.985, p < .001, V = .358$; sex-related, where $\chi^2(1, N = 3,328) = 284.771, p < .001, V = .293$; victim age, where $\chi^2(76, N = 1,463) = 100.641, p = .031, V = .224$; victim's relationship to the arrested officer, where $\chi^2(7, N = 3,070) = 153.358, p < .001, V = .224$; police sexual violence, where $\chi^2(1, N = 3,328) = 151.504, p < .001, V = .213$; Year of arrest, where $\chi^2(49, N = 3,328) = 151.504, p < .001, V = .210$; the difference in years from the age of the arrested officer to the age of the victim, where $\chi^2(99, N = 3,328) = 140.586, p = .004, V = .206$; and, forcible fondling, where $\chi^2(1, N = 3,328) = 137.226, p < .001, V = .203$.

Table 66 presents a backward stepwise binary logistic regression model predicting job loss as a final adverse employment action against an officer after being arrested for a violence-related crime. Bivariate correlations for each of the independent variables in the model indicate that none of the variables are highly correlated with each other. Multicollinearity is not a problem as indicated by no tolerance scores below .572 and no variance inflation factors above

1.747. Autocorrelation is not a problem as indicated by a Durbin-Watson score of 1.715.

Logistic regression results indicate that the overall model of eleven predictors is statistically reliable in distinguishing between officers who kept their job after being arrested and officers who lost their job after being arrested in a violence-related arrest case. Wald statistics indicate that all of the independent variables in the model significantly predict job loss in violence-related cases. The binary logistic regression model correctly classified 79.5% of the cases (AUC = .768, 95% CI [.744, .791], $R^2_{ROC} = .536$).

Context for prediction of job loss in violence-related police crime arrest cases is provided through interpretation of the odds ratios. Five of the independent variables in the logistic regression model predict when an officer is more likely to lose his or her job as a sworn law enforcement officer after being arrested for a violence-related criminal offense. The year of the arrest (within the time period years, 2005-2011) predicts job loss, but this is likely an artifact of the data and potentially resulting from one of several threats to internal validity. The simple odds of job loss are 2.8 times greater if the violence-related crime for which the officer was arrested involved police sexual violence. The relationship of the arrested officer to his or her victim in violence-related police crime arrest cases predicts job loss, as the simple odds of job loss increase by 24.4% for every one unit categorical increase on the eight-point scale of victim relationship (but it is a nominal level variable, so the practical interpretation is imprecise). On that variable (V85 on the coding instrument) the categories are 1 = *victim is current spouse*, 2 = *victim is former spouse*, 3 = *victim is current girlfriend or boyfriend*, 4 = *victim is former girlfriend or boyfriend*, 5 = *victim is child or stepchild*, 6 = *victim is other relative*, 7 = *victim is an unrelated child*, and 8 = *victim is a stranger or nonstranger acquaintance*. As for most of the other prediction models in this study, conviction predicts job loss and job loss predicts

conviction. Here, the simple odds of job loss are 6 times greater in violence-related cases if the arrested officer is ultimately convicted in criminal court of at least one of the offenses charged against the officer. Some of the officers in the current study who were arrested were also named as a party-defendant in one or more federal court civil actions alleging civil rights violations at some point during an officer's career as a sworn law enforcement officer. In this model, the simple odds of job loss in violence-related arrest cases are 2.4 times greater if the arrested officer was sued (at some point during the officer's law enforcement career) in a state court civil action that was removed to a United States District Court pursuant to 28 U.S.C. §1441.

Six of the independent variables in the logistic regression model predict when job loss is less likely to occur in violence-related police crime arrest cases. As age goes up, the likelihood of job loss goes down: the simple odds of job loss go down by 10% for every one categorical unit (3 year) increase in the age of the officer at time of his or her arrest for a violence-related crime. The officer's status at time of committing the crime for which he or she was arrested also predicts job loss. The simple odds of job loss decrease by 48.9% if the officer was acting in his or her official capacity as a sworn law enforcement officer when he or she committed the violence-related crime for which the officer was arrested. The employing agency's response also predicts, in terms of adverse employment actions short of job loss after an officer's arrest, when job loss is unlikely. The simple odds of job loss decrease by 70.6% if an officer was reassigned to another position within the agency after being arrested for a violence-related crime. Similarly, the simple odds of job loss decrease by 76.8% if an officer was suspended from his or her job for a period of time after being arrested for a violence-related crime. Interestingly, the simple odds of job loss go down by 94.2% if the violence-related arrest case also involved the drug cannabis. The sex of the victim in a violence-related police crime arrest case also predicts job loss, as the

simple odds of job loss in a violence-related case goes down by 43.6% if the victim is male (and not a female). Conversely stated, job loss subsequent to an arrest for a violence-related police crime is more likely if the crime victim is a woman or girl than a man or boy.

Figure 23 presents the results of predicting job loss and included a total of 3,328 cases. The tree had an overall classification score of 68.5% (AUC = .756, 95% CI [.740, .772], $R^2_{ROC} = .512$) and selected the variable *criminal conviction* as the splitting criterion. Officers who were convicted (node 1) lost their job in 55.6% of the cases. In contrast, officers who were not convicted (node 2) lost their job in 41.7% of the cases. The officers who were convicted in node 1 were partitioned by the variable *sex-related police crime versus other crime type*. Officers arrested in a sex-related case lost their job in 75.1% of the cases and officers arrested for crimes that were not sex-related lost their job in 45.4% of the cases. The officers who were not convicted in node 2 were partitioned by the variable *sex-related versus other crime type*. Here, officers arrested for a sex-related case lost their job in 68.1% of the cases and officers arrested for crimes that were not sex-related lost their job in 34.1% of the cases. The tree also included the following variables in tiers three through five: year, officer was suspended for a brief period of time, 42 U.S.C. §1983 civil defendant, duty status, simple assault, victim age categorical, age (of the officer), and years of service categorical.

Predicting Conviction in Officer-involved Domestic Violence Arrest Cases

The regression models in this section predict conviction in officer-involved domestic violence arrest cases. Bivariate Chi-Square associations presented in Table 67 are statistically significant at $p < .05$ for 26 independent variables and the dependent variable, *conviction on any offense charged*. There was a strong bivariate association between conviction and the State in which the arrested officer's employing law enforcement agency is located, where $\chi^2 (46, N =$

497) = 80.273, $p = .001$, $V = .402$. There was a moderate bivariate association between conviction and each of the following independent variables: job loss, where $\chi^2 (1, N = 497) = 62.928$, $p < .001$, $V = .356$; sex-related, where $\chi^2 (1, N = 497) = 34.222$, $p < .001$, $V = .356$; simple assault, where $\chi^2 (1, N = 497) = 29.509$, $p < .001$, $V = .244$; victim age (categorical), where $\chi^2 (9, N = 497) = 28.296$, $p = .001$, $V = .239$; victim's relationship to the arrested officer, where $\chi^2 (7, N = 480) = 27.127$, $p < .001$, $V = .238$; geographic division, where $\chi^2 (8, N = 497) = 24.938$, $p = .002$, $V = .224$; and, forcible fondling, where $\chi^2 (1, N = 497) = 24.159$, $p < .001$, $V = .220$.

Table 68 presents a backward stepwise binary logistic regression model predicting conviction in officer-involved domestic violence arrest cases. Bivariate correlations computed for each of the independent variables in the model revealed that none of the variables were highly correlated with each other. Multicollinearity is not a problem as indicated by no tolerance scores below .775 and no variance inflation factors above 1.290. Autocorrelation is not a problem as indicated by a Durbin-Watson score of 1.956. Logistic regression results indicate that the overall model of ten predictors is statistically reliable in distinguishing between criminal conviction and nonconviction in officer-involved domestic violence arrest cases. Wald statistics indicate that all of the independent variables in the model significantly predict conviction in officer-involved domestic violence arrest cases. The logistic regression model correctly classified 76.9% of the cases (AUC = .820, 95% CI [.782, .858], $R_{ROC}^2 = .640$).

Interpretation of the odds ratios provides context for prediction of conviction on at least one criminal offense charged against an officer in officer-involved domestic violence arrest cases. Eight of the independent variables in the model predict when an officer is more likely to be convicted versus nonconviction. The outcomes in officer-involved domestic violence arrest

cases demonstrate that the criminal courts are not willing to tolerate certain things from officers who are arrested. The simple odds of conviction in an officer-involved domestic violence arrest case are 18.1 times greater if the officer was charged with the offense of obstruction of justice. Similarly, the simple odds of conviction are 7.8 times greater in officer-involved domestic violence arrest cases if the officer was charged with vandalism (e.g., destruction of property, criminal mischief). The simple odds of conviction are 3.6 times greater in cases involving officer-involved domestic violence if the incident is also sex-related. The victim's relationship to the arrested officer in officer-involved domestic violence arrest cases also predicts conviction. The simple odds of conviction increase by 14.2% for every one unit categorical increase on the eight-point scale of victim relationship. The interpretation of victim relationship can be better explained in the regression tree analysis directly below.

There are several variables specific to cases involving officer-involved domestic violence that predict the odds of criminal conviction. First, the simple odds of conviction are 1.2 times greater if the officer uses or threatens to use a personally-owned gun. Second, the simple odds of conviction are 3.7 times greater if the arrested officer violated a domestic order of protection. Third, the simple odds of conviction are 6.7 times greater if the victim of the officer-involved domestic violence is fatally injured as a result of the crime for which the officer was arrested. Conversely, the simple odds of conviction decrease by 44.4% if the victim of an officer-involved domestic violence arrest case is injured (nonfatal injuries). Once again, in this model job loss predicts conviction. The simple odds of conviction are three times greater if the arrested officer ultimately loses his or her job in the aftermath of being arrested in a case of officer-involved domestic violence. Lastly, the location geographically predicts the criminal case disposition in officer-involved domestic violence arrest cases. Logistic regression provides no meaningful

interpretation of the odds ratio for geographic region within the United States, and the regression tree analysis in the next paragraph provides context for interpretation of geographic location.

Figure 24 presents the results of predicting conviction and included a total of 499 arrest cases. The tree had an overall classification score of 73.9% (AUC = .781, 95% CI [.741, .822], $R^2_{ROC} = .562$) and selected the variable *job lost* as the splitting criterion. Officers who had not lost their job (node 1) were convicted in 36.2% of the cases. In contrast, officers who lost their job (node 2) were convicted in 71.5% of the cases. Cases in node 1 were further partitioned by the variable *year of arrest*. Officers who were arrested during years 2005-2006 were convicted in 63.5% of the cases and officers who were arrested in years 2007-2011 were convicted in 26% of the cases. Cases in node 2 were further separated by the variable *geographic division*. Cases from the East North Central, West North Central, and Middle Atlantic divisions of the United States had convictions in 85% of the cases. In contrast, cases from the Pacific, East South Central, South Atlantic, West South Central, New England, and Mountain divisions of the country had convictions in 62.5% of the cases. The tree also included the following variables in tier three: state and victim's relationship to the offender.

Predicting Job Loss in Officer-involved Domestic Violence Arrest Cases

The set of regression models in this section predict job loss in officer-involved domestic violence arrest cases. Chi-Square bivariate associations presented in Table 69 are statistically significant at $p < .05$ for 40 independent variables and the dependent variable, *job loss*. The strength of the statistically significant bivariate associations is moderate for each of six independent variables and job loss: criminal conviction, where $\chi^2(1, N = 497) = 62.928, p < .001, V = .356$; the difference in years between the age of the arrested officer and the age of the victim, where $\chi^2(65, N = 961) = 85.555, p = .045, V = .298$; the State in which the arrested

officer's employing law enforcement agency was located, where $\chi^2 (49, N = 961) = 81.166, p = .003, V = .291$; sex-related, where $\chi^2 (1, N = 961) = 51.384, p < .001, V = .231$; year of arrest, where $\chi^2 (6, N = 961) = 41.162, p < .001, V = .207$; and, forcible fondling, where $\chi^2 (1, N = 961) = 39.122, p < .001, V = .202$.

Table 70 presents a backward stepwise binary logistic regression model predicting job loss as a final adverse employment action against an officer after being arrested for an offense relating to officer-involved domestic violence. Bivariate correlations for each of the independent variables in the model indicate that none of the variables are highly correlated with each other. Multicollinearity is not a problem as indicated by no tolerance scores below .883 and no variance inflation factors above 1.132. Autocorrelation is not a problem as indicated by a Durbin-Watson score of 1.941. Logistic regression results indicate that the overall model of nine predictors is statistically reliable in distinguishing between police crime arrest cases where officers kept their job and cases where officers lost their job after being arrested for an incident of officer-involved domestic violence. Wald statistics indicate that all of the independent variables in the model significantly predict job loss in officer-involved domestic violence arrest cases. The logistic regression model correctly classified 72.2% of the cases (AUC = .800, 95% CI [.762, .839], $R_{ROC}^2 = .600$).

Interpretation of odds ratios in officer-involved domestic violence arrest cases provides context for prediction of job loss. Duty status predicts job loss, as the simple of job loss are 5.3 times greater if the officer was on-duty when he or she was alleged to have committed officer-involved domestic violence that resulted in the officer's arrest. The simple odds of job loss in officer-involved domestic violence arrest cases are 1.6 times greater if the arrested officer used other body parts (not hands or fist) as a weapon against the crime victim. The simple odds of job

loss go down by 50.9% in officer-involved domestic violence arrest cases if the officer was charged with simple (misdemeanor) assault. The simple odds of job loss are 4.4 times greater if the officer arrested in an officer-involved domestic violence case was convicted of at least one criminal offense. The simple odds of job loss, however, decreased by 49% if an officer arrested for a crime stemming from officer-involved domestic violence was suspended from his or her job as a sworn officer for a period of time after being arrested. Officers arrested for crimes relating to officer-involved domestic violence are more likely to lose their job as a sworn law enforcement officer if their employing law enforcement agency is located in a rural area. The simple odds of job loss increase by 52.1% for every one unit increase in rurality of the county (or independent city) where the officer's employing agency is located. Here again we also see a relationship between job loss in a police crime arrest case and instances where officers have been sued in federal court at some point during their career for violating someone's civil rights. The simple odds of job loss in police crime arrest cases stemming from officer-involved domestic violence are 2.1 times greater if at some point during the arrested officer's career, that officer was sued in a state court for violating someone's civil rights and the civil case was removed by a civil defendant to a United States District Court pursuant to the provisions of 28 U.S.C. §1441.

Figure 25 presents the results of predicting job loss and included a total of 965 arrest cases. The tree had an overall classification score of 69.2% (AUC = .739, 95% CI [.707, .770], $R^2_{ROC} = .478$) and selected the variable *case disposition: officer was convicted of a crime* as the splitting criterion. Officers who were convicted of at least one criminal offense charged (node 1) lost their job in 51.8% of the cases. In contrast, officers who were not convicted of any offense charged (node 2) lost their job in 25% of the cases. The officers who were convicted in node 1 were further partitioned by the variable *year of arrest*. Officers arrested during the years 2005-

2007 lost their job in 37.8% of the cases and officers arrested during years 2008-2011 lost their job in 61.4% of the cases. The officers who were not convicted in node 2 were partitioned by the variable *full-time sworn personnel*. Arrested officers employed by law enforcement agencies with 1-249 sworn officers lost their job in 32.5% of the cases and arrested officers employed by agencies with 250-1000+ sworn officers lost their job in 16.7% of the cases. The tree also included the following variables in tiers three through five: age categorical and geographic division.

Part VI: Profit-motivated Police Crime Data Set Models

There are 1,592 cases in the data set in which sworn nonfederal law enforcement officers were arrested for profit-motivated crimes during the period January 1, 2005, through December 31, 2011. The profit-motivated arrest cases involve 1,396 individual officers employed by 782 state, local, special, constable, and tribal law enforcement agencies located in 531 counties and independent cities in 47 states and the District of Columbia (all states except Idaho, Maine, and North Dakota). Of these 1,396 officers who were arrested for profit-motivated crimes, 94 of the arrested officers have more than one case ($\bar{X} = 1.14$, $Mdn = 1.00$, $Mode = 1$, $SD = .808$) because they have more than one crime victim (one criminal case per crime victim) and/or were arrested for a profit-motivated crime on more than one occasion during the study years 2005-2011. More than two-thirds of the profit-motivated criminal cases involved an arrested officer who is known to have lost his or her job ($n = 1,080$, 67.9%). The known final adverse employment outcomes in these cases include no action against the arrested officer ($n = 135$, 8.5%), suspended ($n = 376$, 23.6%), voluntarily resigned ($n = 503$, 31.6%), and involuntarily terminated ($n = 577$, 36.3%). More than half of the profit-motivated arrest cases resulted in a conviction ($n = 914$, 57.4%) on one or more offenses charged in the case.

Officers Arrested for Profit-motivated Police Crime, Offenses & Employing Agencies

Table 71 presents descriptive information on the profit-motivated police crime arrest cases in terms of the arrested officer and the offenses charged, as well as information on the employing law enforcement agency and the arresting law enforcement agency. Most of the profit-motivated arrest cases involve male officers ($n = 1,497$, 94.1%). The modal category for known officer age at time of arrest is ages 36-39 ($n = 244$, 15.3%). The youngest officer arrested for a profit-motivated police crime was 20 years old at time of arrest, and the oldest was 79 years

old (\bar{X} age = 38.01, *Mdn* age = 37,00, Mode age = 41, *SD* = 9.097 years). The modal category for known years of service as a sworn law enforcement officer at time of arrest is 3-5 years (n = 197, 12.4%) (\bar{X} years of service = 10.90, *Mdn* years of service = 10.00, Mode years of service = 4, *SD* = 7.808 years). Most of the profit-motivated police crime arrest cases involve sworn officers in patrol and street-level ranks, including nonsupervisory officers, deputies, troopers, and detectives (n = 1,243, 78.1%). Other profit-motivated police crime arrest cases include mid-rank line and field supervisors (n = 208, 13.1%) and high-ranking police managers and executives (n = 140, 8.8%). More than two-thirds of the profit-motivated arrest cases involve crimes that were committed while on-duty (n = 1,093, 68.7%). Even so, two-thirds of the cases (n = 1,081, 67.9%) involve an arrest made by some law enforcement agency other than the agency employing the arrested officer.

Most of the profit-motivated police crime arrest cases involve officers employed by municipal police departments (n = 1,162, 73.0%) or sheriff's offices (n = 251, 15.8%). The arrest cases also involve officers who were employed by primary state police agencies (n = 62, 3.9%), county police departments (n = 66, 4.2%), special police departments (n = 42, 2.6%), constable agencies (n = 7, 0.4%), and tribal police departments (n = 1, 0.1%). The modal category for size of the employing law enforcement agency by the number of full-time sworn officers employed is 1,000 or more full-time sworn officers (n = 495, 31.1%) and zero part-time sworn officers (n = 1,209, 76.1%). The majority of officers arrested in profit-motivated police crime arrest cases were employed by a nonfederal law enforcement agency located in a nonrural metropolitan county or independent city (n = 1,312, 82.5%). The employing agencies are located throughout the United States, including agencies in the Southern states (n = 726, 45.6%),

Northeastern states ($n = 362$, 22.8%), Midwestern states ($n = 329$, 20.7%), and Western states ($n = 174$, 10.9%).

Table 72 presents the profit-motivated police crime arrest cases in terms of the most serious offense charged in each case. There are 46 separate criminal offense categories represented as the most serious offense charged in the profit-motivated police crime arrest cases in years 2005-2011. Most common as the most serious offense charged in the profit-motivated cases are unclassified thefts ($n = 255$, 16.0%), false pretenses (known as theft by deception in Model Penal Code states) ($n = 199$, 12.5%), drug offenses ($n = 189$, 11.9%), robbery ($n = 103$, 6.4%), thefts from buildings ($n = 92$, 5.8%), and extortion and blackmail ($n = 85$, 5.3%).

Victims of Profit-motivated Police Crime

Table 73 presents victim characteristics in profit-motivated police crime arrest cases in years 2005-2011. Victim information was not ascertainable from the source documents in many of the profit-motivated police crime arrest cases. Most of the known victims are male ($n = 195$, 83.3%). Almost none of the known victims are children under the age of 18 (98.2% of the known victims are adults age 18 or older). Most of the known victims are strangers or nonstranger acquaintances ($n = 350$, 21.9%) to the arrested officer.

Predicting Conviction in Profit-motivated Police Crime Arrest Cases

In this section the regression models predict criminal conviction on any offense charged in profit-motivated police crime arrest cases versus nonconviction. Conviction data are available on over two-thirds of the profit-motivated cases ($n = 1,105$, 69.5%). Of those cases with known criminal case outcomes, most of the officers arrested for profit-motivated crimes were convicted ($n = 914$, valid 82.7%) on at one offense charged in the case. Bivariate Chi-Square associations, presented in Table 74, are statistically significant at the $p < .05$ level for 49 independent variables

and the dependent variables, *conviction on any offense charged*. There are six bivariate associations of moderate strength as indicated by the Cramer's V scores for the statistically significant Chi-Square statistics. The statistically significant bivariate associations of moderate strength are the victim's relationship to the arrested officer, where $\chi^2(6, N = 266) = 25.017, p < .001, V = .307$; age of the officer at time of arrest, where $\chi^2(49, N = 1,010) = 85.828, p = .001, V = .292$; the State where the arrested officer's employing law enforcement agency is located, where $\chi^2(47, N = 1,105) = 88.251, p < .001, V = .283$; years of service at time of arrest, where $\chi^2(39, N = 799) = 62.423, p = .010, V = .280$; job loss, where $\chi^2(1, N = 1,105) = 82.094, p < .001, V = .273$; and categorical age, where $\chi^2(10, N = 1,105) = 44.496, p < .001, V = .201$.

Table 75 presents a backward stepwise binary logistic regression model predicting conviction in profit-motivated police crime arrest cases. Bivariate correlations computed for each of the independent variables in the logistic regression model revealed that none of the variables were highly correlated with each other. Multicollinearity is not a problem as indicated by no tolerance scores below .696 and no variance inflation factors above 1.436. The Durbin-Watson score of 1.659 indicates that autocorrelation is not a problem in the model. Logistic regression results indicate that the overall model of nine predictors is statistically reliable in distinguishing between conviction in profit-motivated police crime arrest cases and nonconviction in profit-motivated police crime arrest cases. The model correctly classified 83.8% of the cases (AUC = .593, 95% CI [.547, .639], $R_{ROC}^2 = .186$). Wald statistics indicate that all of the independent variables in the binary logistic regression model significantly predict conviction in profit-motivated police crime arrest cases.

Odds ratio interpretations provide context for prediction of conviction in profit-motivated police crime arrest cases. The single largest predictor of conviction in the profit-motivated arrest

cases is whether the officer's crime involved a drug-related shakedown. The simple odds of conviction are 109 times greater if the profit-motivated police crime involved a drug-related shakedown. Job loss also predicts conviction in profit-motivated police crime arrest cases. The simple odds of conviction in a profit-motivated case are 23.2 times greater if the arrested officer ultimately loses their job (either through involuntary termination or through voluntary resignation) as the final adverse employment outcome following an officer's arrest for a profit-motivated police crime. Violence-related police crime also predicts criminal conviction in profit-motivated police crime arrest cases. The simple odds of conviction are 4.3 times higher if an officer's profit-motivated police crime is also violence-related. The type of nonfederal law enforcement agency employing the arrested officer and the State where the employing agency is located also predict criminal conviction in profit-motivated police crime arrest cases. The simple odds of conviction in profit-motivated police crime arrest cases increase by 68% for every one unit increase in agency type. Agency type is a categorical variable where 1 = *primary state police agency*, 2 = *primary state police agency*, 3 = *sheriff's office*, 4 = *county police department*, 5 = *municipal police department*, 6 = *special police department*, 7 = *constable agency*, 8 = *tribal police department*, and 9 = *regional police department*. As a literal interpretation (remembering that this variable is a nominal-level measurement), that means as you move away from primary state police agencies to other types of police departments, the greater the likelihood of conviction. There is no practical interpretation of the odds ratio for State where the officer's employing nonfederal law enforcement agency was located, other than to note that the simple odds of conviction in profit-motivated police crime arrest cases varies from State to State.

Several variables in the logistic regression model predict when criminal conviction (on any offense charged in the case against the arrested officer) is less likely. Here, the number of part-time sworn officers employed by the agency where the arrested officer works predicts conviction. The simple odds of conviction go down by 27.2% for every one unit categorical increase in the number of part-time sworn officers employed by the agency. The media and public perception surrounding an officer's arrest for profit-motivated police crime also impacts on conviction. The simple odds of conviction goes down by 96.3% if the arrested officer's chief is under scrutiny as a result of the officer's arrest for a profit-motivated police crime. Although in the same model profit-motivated police crime arrest cases that involve a drug-related shakedown increases the simple odds of conviction, drug-related shakedowns in the form of off-duty robberies decreases the odds of conviction. The simple odds of conviction decrease by 98.9% if the officer's profit-motivated police crime arrest case involves a drug-related shakedown in the form of an off-duty robbery. Finally, the age of the victim in a profit-motivated police crime arrest case predicts the likelihood of conviction. The simple odds of conviction decrease by 30% for every one unit categorical increase in the age of the victim in a profit-motivated police crime arrest case.

Figure 26 presents the results of predicting conviction for the profit-motivated cases and included a total of 1,105 police crime arrest cases. The tree had an overall classification score of 85.2% (AUC = .781, 95% CI [.744, .818], $R_{ROC}^2 = .562$) selected the variable *job loss* as the splitting criterion. Officers who had not lost their job (node 1) were convicted in 62.4% of the cases. In contrast, officers who lost their job (node 2) were convicted in 87.9% of the cases. The officers who had not lost their job in node 1 were partitioned by the variable *year of arrest*. Officers who were arrested from 2005-2006 were convicted in 83.6% of the cases. Officers who

were arrested in years 2007-2009 were convicted in 34.2% of the cases and officers who were arrested in years 2010- 2011 were convicted in 59.9% of the cases. The officers who had lost their job in node 2 were partitioned by the variable *urban/rural continuum*. Officers who were employed by agencies located metropolitan counties (or independent cities) of 250,000 to 1 million; a nonmetropolitan county with an urban population of 20,000 or more, not adjacent to a metro area; county in a metropolitan areas of fewer than 250,000 population, adjacent to a metropolitan area; or a nonmetropolitan county with an urban population of 20,000 or more, adjacent to a metropolitan area were convicted in 79.6% of the cases. Officers who were employed by a law enforcement agency located in a county within a metropolitan area of 1 million population or more; nonmetropolitan county with an urban population 2,500 to 19,999, adjacent to a metropolitan area; nonmetropolitan county with urban population of 2,500 to 19,999, not adjacent to a metropolitan area; nonmetropolitan county completely rural or less than 2,500 urban population, not adjacent to a metropolitan area; nonmetropolitan county completely rural or less than 2,500 urban population, adjacent to a metropolitan area were convicted in 92.6% of the cases. The tree also included the following variables in tier three: drug/narcotic violation, urban/rural continuum, arresting agency, and geographic region.

Predicting Job Loss in Profit-motivated Police Crime Arrest Cases

In this section the regression models predict job loss following an officer's arrest for a profit-motivated police crime. Bivariate Chi-Square associations are statistically significant at the $p < .05$ level for 47 independent variables and the dependent variable, *job loss binary* (coded as 0 = *kept job* and 1 = *lost job*) and are presented in Table 76. There are five bivariate associations of moderate strength as indicated by the Cramer's V scores for the statistically significant Chi-Square statistics. They are: year of arrest, where $\chi^2(6, N = 1,591) = 155.340, p <$

.001, $V = .312$; State where the arrested officer's employing law enforcement agency is located, where $\chi^2 (47, N = 1,591) = 126.335, p < .001, V = .282$; whether the officer was convicted (for any offense charged in the arrest case), where $\chi^2 (1, N = 1,105) = 82.094, p < .001, V = .273$; whether the officer was suspended for a period of time following his or her arrest for a profit-motivated crime, where $\chi^2 (1, N = 1,591) = 87.439, p < .001, V = .234$; and, years of service as a sworn law enforcement officer at time of arrest, where $\chi^2 (39, N = 1,126) = 56.457, p = .035, V = .224$.

Table 77 presents a backward stepwise binary logistic regression model predicting job loss in profit-motivated police crime arrest cases. None of the independent variables are highly correlated with each other, as indicated by bivariate correlations that were computed for each of the independent variables in the logistic regression model. Multicollinearity is not a problem as indicated by no tolerance scores below .766 and no variance inflation factors above 1.306. Autocorrelation is not a problem in the model as indicated by a Durbin-Watson score of 1.523. Logistic regression results indicate that the overall model of seven predictors is statistically reliable in distinguishing between officers who lost their jobs after being arrested in a profit-motivated police crime case, and others who kept their jobs after being arrested in a profit-motivated police crime case. Wald Statistics indicate that all of the independent variables in the model significantly predict job loss in profit-motivated police crime arrest cases. The model correctly classified 91.7% of the cases (AUC = .668, 95% CI [.626, .711], $R^2_{ROC} = .336$).

Context for prediction of job loss in profit-motivated police crime arrest cases is provided through interpretation of odds ratios. Five of the independent variables in the logistic regression model predict when an officer is more likely to lose his or her job as a sworn law enforcement officer after being arrested for a profit-motivated police crime. The single largest predictor of

job loss is when the profit-motivated crime is also drug-related. The simple odds of job loss are 45.6 times greater in a profit-motivated police crime arrest case if the case also involves drug selling, dealing, and/or trafficking. Conviction also predicts job loss, but here again it is not possible to establish causal order between conviction and job loss with this data set. The simple odds of job loss are ten times greater in profit-motivated police crime arrest cases if the arrested officer is ultimately convicted on one or more criminal offenses charged in the case. Profit-motivated crimes that are committed by an officer in their official capacity as a sworn law enforcement officer (as opposed to profit-motivated crimes committed by an officer in their individual capacity) also predict job loss. The simple odds of job loss are nine times greater in profit-motivated police crime arrest cases if the crime was committed by the arrested officer in their official capacity. Similarly, profit-motivated crimes that are also internal crimes against the organization (that is, a crime against the arrested officer's employing law enforcement agency) increase the simple odds of job loss by 46.4%. The geographic location of the arrested officer's employing law enforcement agency also predicts job loss in profit-motivated police crime arrest cases. The simple odds of job loss increase by 69.5% in profit-motivated cases with every one unit increase in the category of geographic division across the United States. There is no practical interpretation of the odds ratio, however, for geographic division in this binary logistic regression model.

Two independent variables in the logistic regression model predict when an officer is going to keep their job as a sworn law enforcement officer after being arrested in a profit-motivated police crime arrest case. The first of these is when an officer is charged with the offense of obstruction of justice in a profit-motivated case, where the simple of job loss decrease by 93.5%. In some of the profit-motivated police crime arrest cases there was discussion in the

news article narratives of an agency scandal or cover up in the aftermath of an officer being arrested. The simple odds of job loss decrease by 92.5% in profit-motivated police crime arrest cases if there is discussion of a scandal or cover up at the employing officer's law enforcement agency.

Figure 27 presents the results of predicting conviction for the profit-motivated cases and included a total of 1,591 arrest cases. The tree had an overall classification score of 76.6% (AUC = .788, 95% CI [.763, .812], $R^2_{ROC} = .576$) and selected the variable *case disposition: officer was convicted of a crime* as the splitting criterion. Officers who were convicted (node 1) lost their job in 54.8% of the cases. In contrast, officers who were not convicted (node 2) lost their job in 87.9% of the cases. The officers who were convicted in node 1 were partitioned by the variable *year of arrest*. Officers who were arrested from 2005-2007 were convicted in 51.8% of the cases and officers who were arrested in years 2008-2011 were convicted in 81.3% of the cases. Officers who were not convicted in node 2 were partitioned by the variable *discussion of an agency scandal or cover up*. Officers involved in cases that discussed an agency scandal or cover up lost their job in 24.2% of the cases. In contrast, officers who were not involved in cases that involved some sort of an agency scandal or cover up lost their job in 60.8% of the cases. The tree also included the following variables in tiers three through five: geographic division, year, state, discussion of an agency scandal or cover up, years of service, and type of agency.

Part VII: Employing Law Enforcement Agencies of Arrested Officers

The 6,724 police crime arrest cases in this study involve 5,545 individual sworn law enforcement officers employed by 2,529 nonfederal law enforcement agencies located in headquartered in 1,166 counties and independent cities in all 50 states and the District of Columbia.⁵ In this part the unit of analysis is changed from *arrest case* to *arrested individual officer*. The purpose of changing the unit of analysis to individual officers is to provide rates of officers arrested per agency, per 1,000 officers, and per 100,000 population. Individual nonfederal sworn law enforcement officers were arrested at a rate of 0.72% officers arrested per 1,000 officers, and at a rate of 1.7 officers arrested per 100,000 population nationwide.

We urge caution on one critically important point: the tables (and table appendices) presented in this part of the report, and the data from which they were compiled, cannot support a direct comparison of one agency to another nor indeed any cluster of agencies to others. Though it is a natural tendency to make such comparisons, the many localized conditions invisible to the research team in our data sources prevent accurate comparisons. Among the factors that data sources do not (and likely often cannot) discern are whether an officer's arrest was instigated by his or her own department as a result of its internal standards for conduct and integrity; whether the arrested officer's criminal offense(s) would not have resulted in the officer's arrest if it had been less publicly visible; and whether arrests of police officers by outside law enforcement agencies were made at the request of an officer's employing agency or

⁵ In Part I of this report we identified 2,529 nonfederal law enforcement agencies located in 1,205 counties and independent cities across the United States. In coding of police crime arrest cases for this study, the counties where an employing law enforcement agency was located were logged for both (a) the county (or independent city) where the employing agency was headquartered, and (b) the county (or independent city) where the arrested officer was stationed. In the case of a state trooper, for example, the county would be recorded for the location of the agency headquarters as well as the county where the arrested trooper's assigned barracks was located.

in spite of attempts by that agency to conceal the offense(s) and/or protect the officer's (and thus, the employing agency's) public image.

Rates of Officers Arrested in the 200 Largest Agencies

Table 78 presents the 200 largest employing state and local law enforcement agencies in terms of rates of officers arrested during the study period years 2005-2011. The table is sorted by the number of full-time sworn officers employed from largest agency to the smallest agency within the largest 200 agencies represented in the study. The same table is also presented in alternative versions as Appendix B-1 (200 largest agencies in the study sorted by rates of officers arrested per 1,000 officers) and Appendix C-1 (200 largest agencies in the study sorted by rates of officers arrested per 100,000 population). The ten large agencies with the highest rates of officers arrested per 1,000 officers are New Orleans Police Department (rate of 44.21 officers arrested per 1,000 officers), Milwaukee Police Department (rate of 36.74 officers arrested per 1,000 officers), Memphis Police Department (rate of 29.70 officers arrested per 1,000 officers), New Mexico State Police (rate of 24.62 officers arrested per 1,000 officers), Pittsburgh Police Department (rate of 23.57 officers arrested per 1,000 officers), Shreveport Police Department (rate of 23.48 officers arrested per 1,000 officers), Polk County (FL) Sheriff's Office (rate of 21.67 officers arrested per 1,000 officers), Kern County (CA) Sheriff's Office (rate of 21.48 officers arrested per 1,000 officers), Indianapolis Police Department (rate of 20.87 officers arrested per 1,000 officers), and Minneapolis Police Department (rate of 19.96 officers arrested per 1,000 officers). See Appendix B-1.

The ten large agencies with the highest rates of officers arrested per 100,000 population are New Orleans Police Department (rate of 18.32 officers arrested per 100,000 population), Baltimore Police Department (rate of 8.86 officers arrested per 100,000 population), Milwaukee

Police Department (rate of 7.70 officers arrested per 100,000 population), Norfolk Police Department (rate of 5.77 officers arrested per 100,000 population), Memphis Police Department (rate of 4.96 officers arrested per 100,000 population), Washington Metropolitan Police Department (rate of 4.82 officers arrested per 100,000 population), Shreveport Police Department (rate of 4.71 officers arrested per 100,000 population), Philadelphia Police Department (rate of 4.33 officers arrested per 100,000 population), Jackson Police Department (rate of 4.67 officers arrested per 100,000 population), and Indianapolis Police Department (rate of 3.65 officers arrested per 100,000 population). See Appendix C-1.

Rates of Officers Arrested in Nonmetropolitan Agencies

Table 79 presents the employing law enforcement agencies located in nonmetropolitan (rural) counties and independent cities in terms of rates of officers arrested during the study period years 2005-2011. The table is sorted by agency name in alphabetical order. The same table information is also presented in alternative versions as Appendix A-1 (sorted by the number of full-time sworn personnel employed), Appendix B-2 (sorted by rate of officers arrested per 1,000 officers), and Appendix C-2 (sorted by rate of officers arrested per 100,000 population).

The law enforcement agencies located in nonmetropolitan counties and independent cities with the highest rates of officers arrested per 1,000 officers are Mounds (IL) Police Department (rate of 2000.00 officers arrested per 1,000 officers) and Atwater (MN) Police Department, Berlin Borough (PA) Police Department, Berlin Heights (OH) Police Department, Bowman (SC) Police Department, Burr Oak (MI) Police Department, Cooter (MO) Police Department, Elgin (ND) Police Department, Hamburg (IA) Police Department, Lamoure (ND) Police Department, Lockhart (AL) Police Department, Marion Township (WI) Police Department, Nicholas County (KY) Sheriff's Office, Oakwood (OH) Police Department, Perryville (KY) Police Department,

Petroleum County (MT) Sheriff's Office, Pineview (GA) Police Department, Tipton (OK) Police Department, Turkey Creek (LA) Police Department, Wakeman (OH) Police Department, Wilson (KS) Police Department, and Zolfo Springs (FL) Police Department (each with a rate of 1000.00 officers arrested per 1,000 police officers). See Appendix B-2.

The law enforcement agencies located in nonmetropolitan counties and independent cities with the highest rates of officers arrested per 100,000 population are Petroleum County (MT) Sheriff's Office (rate of 202.43 officers arrested per 100,000 population), Terrell County (TX) Sheriff's Office (rate of 101.63 officers arrested per 100,000 population), Talbot County (GA) Sheriff's Office (rate of 43.70 officers arrested per 100,000 population), La Salle County (TX) Sheriff's Office (rate of 43.57 officers arrested per 100,000 population), Elgin (ND) Police Department (rate of 41.77 officers arrested per 100,000 population), Griggs County (ND) Sheriff's Office (rate of 41.32 officers arrested per 100,000 population), Crystal City (TX) Police Department (rate of 34.26 officers arrested per 100,000 population), Mounds (IL) Police Department (rate of 32.46 officers arrested per 100,000 population), Pulaski County (IL) Sheriff's Office (rate of 32.46 officers arrested per 100,000 population), and Carter County (MO) Sheriff's Office (rate of 31.92 officers arrested per 100,000 population). See Appendix C-2.

Rate of Officers Arrested in Primary State Police Agencies

Table 80 presents the employing primary state police agencies in terms of rates of officers arrested during the study period years 2005-2011. The table is sorted by agency name in alphabetical order. The same table information is also presented in alternative versions as Appendix A-2 (sorted by the number of full-time sworn personnel employed), Appendix B-3 (sorted by rate of officers arrested per 1,000 officers), and Appendix C-3 (sorted by rate of officers arrested per 100,000 population).

The five primary state police agencies with the highest rates of officers arrested per 1,000 officers are New Mexico State Police (rate of 24.62 officers arrested per 1,000 officers), Arkansas Highway Patrol (rate of 13.42 officers arrested per 1,000 officers), South Carolina Highway Patrol (rate of 10.34 officers arrested per 1,000 officers), Mississippi Highway Safety Patrol (rate of 10.10 officers arrested per 1,000 officers), and Rhode Island State Police (rate of 9.95 officers arrested per 1,000 officers). See Appendix B-3. The five primary state police agencies with the highest rates of officers arrested per 100,000 population are New Mexico State Police (rate of 0.63 officers arrested per 100,000 population), Delaware State Police (rate of 0.33 officers arrested per 100,000 population), New Hampshire State Police (rate of 0.23 officers arrested per 100,000 population), South Carolina Highway Patrol (rate of 0.22 officers arrested per 100,000 population), and Mississippi Highway Safety Patrol (rate of 0.20 officers arrested per 100,000 population). See Appendix C-3.

Rates of Officers Arrested in Sheriff's Offices

Table 81 presents the employing sheriff's offices in terms of rates of officers arrested during the study period years 2005-2011. The table is sorted by agency name in alphabetical order. The same table information is also presented in alternative versions as Appendix A-3 (sorted by the number of full-time sworn personnel employed), Appendix B-4 (sorted by rate of officers arrested per 1,000 officers), and Appendix C-4 (sorted by rate of officers arrested per 100,000 population).

The sheriff's offices with the highest rates of officers arrested per 1,000 officers are Nicholas County (KY) Sheriff's Office (rate of 1000.00 officers arrested per 1,000 officers), Petroleum County (MT) Sheriff's Office (rate of 1000.00 officers arrested per 1,000 officers), Carter County (MO) Sheriff's Office (rate of 666.67 officers arrested per 1,000 officers), Oregon

County (MO) Sheriff's Office (rate of 400.00 officers arrested per 1,000 officers), Talbot County (GA) Sheriff's Office (rate of 375.00 officers arrested per 1,000 officers), Baker County (GA) Sheriff's Office (rate of 333.33 officers arrested per 1,000 officers), Butler County (AL) Sheriff's Office (rate of 333.33 officers arrested per 1,000 officers), Gallatin County (IL) Sheriff's Office (rate of 333.00 officers arrested per 1,000 officers), Griggs County (ND) Sheriff's Office (rate of 333.00 officers arrested per 1,000 officers), and Guadalupe County (NM) Sheriff's Office (rate of 333.00 officers arrested per 1,000 officers). See Table B-4.

The sheriff's offices with the highest rates of officers arrested per 100,000 population are Petroleum County (MT) Sheriff's Office (rate of 202.43 officers arrested per 100,000 population), Terrell County (TX) Sheriff's Office (rate of 101.63 officers arrested per 100,000 officers), Talbot County (GA) Sheriff's Office (rate of 43.70 officers arrested per 100,000 officers), La Salle County (TX) Sheriff's Office (rate of 43.57 officers arrested per 100,000 officers), Griggs County (ND) Sheriff's Office (rate of 41.32 officers arrested per 100,000 officers), Pulaski County (IL) Sheriff's Office (rate of 32.46 officers arrested per 100,000 officers), Carter County (MO) Sheriff's Office (rate of 31.92 officers arrested per 100,000 officers), Baker County (GA) Sheriff's Office (rate of 28.98 officers arrested per 100,000 officers), Lake County (CO) Sheriff's Office (rate of 27.36 officers arrested per 100,000 officers), and Henry County (VA) Sheriff's Office (rate of 25.85 officers arrested per 100,000 population).

Rates of Officers Arrested in County Police Departments

Table 82 presents the employing county police departments in terms of rates of officers arrested during the study period years 2005-2011. The table is sorted by agency name in alphabetical order. The same table information is also presented in alternative versions as

Appendix A-4 (sorted by the number of full-time sworn personnel employed), Appendix B-5 (sorted by rate of officers arrested per 1,000 officers), and Appendix C-5 (sorted by rate of officers arrested per 100,000 population).

The county police departments included in the study with the highest rate of officers arrested per 1,000 officers are Polk County (GA) Police Department (rate of 85.71 officers arrested per 1,000 officers), Oldham County (KY) Police Department (rate of 64.52 officers arrested per 1,000 officers), Dougherty County (GA) Police Department (rate of 42.55 officers arrested per 1,000 officers), Horry County (SC) Police Department (rate of 37.04 officers arrested per 1,000 officers), Kauai (County) (HI) Police Department (rate of 24.00 officers arrested per 1,000 officers), Indianapolis (IN) Metropolitan Police Department (rate of 20.86 officers arrested per 1,000 officers), Fulton County (GA) Police Department (rate of 15.50 officers arrested per 1,000 officers), Maui (County) (HI) Police Department (rate of 15.20 officers arrested per 1,000 officers), Gaston County (NC) Police Department (rate of 15.04 officers arrested per 1,000 officers), and Roanoke County (VA) Police Department (rate of 14.81 officers arrested per 1,000 officers). See Appendix B-5.

The county police departments included in the study with the highest rates of officers arrested per 100,000 population are Polk County (GA) Police Department (rate of 7.23 officers arrested per 100,000 population), Kauai (County) (HI) Police Department (rate of 4.47 officers arrested per 100,000 population), Indianapolis (IN) Metropolitan Police Department (rate of 3.65 officers arrested per 100,000 population), Horry County (SC) Police Department (rate of 3.34 officers arrested per 100,000 population), Oldham County (KY) Police Department (rate of 3.32 officers arrested per 100,000 population), Maui (County) (HI) Police Department (rate of 3.23 officers arrested per 100,000 population), Honolulu (City and County) (HI) Police Department

(rate of 2.73 officers arrested per 100,000 population), Savannah-Chatham (GA) Metropolitan Police Department (rate of 2.26 officers arrested per 100,000 population), Prince George's County (MD) Police Department (rate of 2.20 officers arrested per 100,000 population), Roanoke County (VA) Police Department (rate of 2.17 officers arrested per 100,000 population), and Charlotte-Mecklenburg (NC) Police Department (rate of 2.17 officers arrested per 100,000 population). See Appendix C-5.

Rates of Officers Arrested in 500 Largest Municipal Police Departments

Table 83 presents the 500 largest employing municipal police departments in terms of rates of officers arrested during the study period years 2005-2011. The table is sorted by agency name in alphabetical order. The same table information is also presented in alternative versions as Appendix A-5 (sorted by the number of full-time sworn personnel employed), Appendix B-6 (sorted by rate of officers arrested per 1,000 officers), and Appendix C-6 (sorted by rate of officers arrested per 100,000 population).

The large municipal police departments included in the study with the highest rates of officers arrested per 1,000 officers are Hackensack (NJ) Police Department (rate of 76.92 officers arrested per 1,000 officers), Norwich (CT) Police Department (rate of 61.73 officers arrested per 1,000 officers), Riviera Beach (FL) Police Department (rate of 55.56 officers arrested per 1,000 officers), Lorain (OH) Police Department (rate of 50.0 officers arrested per 1,000 officers), Charleston (WV) Police Department (rate of 49.45 officers arrested per 1,000 officers), Schenectady (NY) Police Department (rate of 48.19 officers arrested per 1,000 officers), Edinburg (TX) Police Department (rate of 45.45 officers arrested per 1,000 officers),

Cleveland (TN) Police Department (rate of 44.94 officers arrested per 1,000 officers), Muskogee (OK) Police Department (rate of 44.44 officers arrested per 1,000 officers), and New Orleans (LA) Police Department (rate of 44.21 officers arrested per 1,000 officers). See Appendix B-6.

The large municipal police departments with the highest rates of officers arrested per 100,000 population are New Orleans (LA) Police Department (rate of 18.32 officers arrested per 100,000 population), Portsmouth (VA) Police Department (rate of 10.47 officers arrested per 100,000 population), Baltimore (MD) Police Department (rate of 8.86 officers arrested per 100,000 population), Milwaukee (WI) Police Department (rate of 7.70 officers arrested per 100,000 population), Clarksville (TN) Police Department (rate of 7.54 officers arrested per 100,000 population), Kansas City (KS) Police Department (rate of 6.35 officers arrested per 100,000 population), Petersburg (VA) Police Department (rate of 6.17 officers arrested per 100,000 population), Macon (GA) Police Department (rate of 5.79 officers arrested per 100,000 population), Norfolk (VA) Police Department (rate of 5.77 officers arrested per 100,000 population), and Muskogee (OK) Police Department (rate of 5.63 officers arrested per 100,000 population). See Appendix C-6.

Rates of Officers Arrested in Special State and Local Law Enforcement Agencies

Table 84 presents the special state and local employing law enforcement agencies in terms of rates of officers arrested during the study period years 2005-2011. The table is sorted by agency name in alphabetical order. The same table information is also presented in alternative versions as Appendix A-6 (sorted by the number of full-time sworn personnel employed), Appendix B-7 (sorted by rate of officers arrested per 1,000 officers), and Appendix C-7 (sorted by rate of officers arrested per 100,000 population).

The special law enforcement agencies with the highest rates of officers arrested per 1,000 officers are Connally I.S.D. (TX) Police Department (rate of 333.33 officers arrested per 1,000 officers), Grambling State University (LA) Police Department (rate of 222.22 officers arrested per 1,000 officers), Ennis I.S.D. (TX) Police Department (rate of 200.00 officers arrested per 1,000 officers), Ventura College (CA) Police Department (rate of 200.00 officers arrested per 1,000 officers), California Exposition and State Fair (CA) Police (rate of 166.67 officers arrested per 1,000 officers), Lancaster I.S.D. (TX) Police Department (rate of 166.67 officers arrested per 1,000 officers), University of Maryland Eastern Shore (MD) Public Safety (rate of 166.67 officers arrested per 1,000 officers), University of West Alabama (AL) Police (rate of 166.67 officers arrested per 1,000 officers), Greenville Technical College (SC) Public Safety (rate of 111.11 officers arrested per 1,000 officers), and Lehigh-Northampton Airport Authority (PA) Police Department (rate of 111.11 officers arrested per 1,000 officers). See Appendix B-7.

The special law enforcement agencies included in the study with the highest rates of officers arrested per 100,000 population are University of Tennessee at Knoxville (TN) Police (rate of 10.47 officers arrested per 100,000 population), University of West Alabama (AL) Police (rate of 7.27 officers arrested per 100,000 population), Tuskegee University (AL) Police Department (rate of 4.66 officers arrested per 100,000 population), Grambling State University (LA) Police Department (rate of 4.28 officers arrested per 100,000 population), University of Maryland Eastern Shore (MD) Public Safety (rate of 3.78 officers arrested per 100,000 population), Georgia Public Safety Training Center (GA) (rate of 3.78 officers arrested per 100,000 population), Ohio Department of Natural Resources (OH) Office of Law Enforcement (rate of 3.24 officers arrested per 100,000 population), Virginia Marine Resources Commission (VA) (rate of 3.02 officers arrested per 100,000 population), Brigham Young University – Idaho

(ID) Police Department (rate of 2.66 officers arrested per 100,000 population), and Missouri University of Science and Technology (MO) Police Department (rate of 2.21 officers arrested per 100,000 population).

CONCLUSION

Cases in which sworn law enforcement officers act as criminals—whether dealing drugs, or driving drunk, or sexually molesting a vulnerable citizen—strike a direct blow to the law enforcement enterprise and the essence of what it means to be a law enforcement officer: protect and serve. These cases threaten to undermine public trust in both the authority and legitimacy of state and local law enforcement organizations, and the work of law-abiding sworn officers who go about their job selflessly, efficiently, and professionally every day. Police crime as a topic worthy of empirical study however is not clearly understood, and would probably best be described as untapped or at the very least not sufficiently explored.

The contrast between the topic's substantive weight and comparatively light coverage within the scholarship is mostly due to an absence of suitable data. The traditional sources of data and methods of study, whether official statistics, self-report surveys, or direct observations, either do not exist in any usable format or are ill-equipped to identify, count, or provide the basis for empirical analyses of instances in which police perpetrate crimes themselves. These cases have thus far escaped large-scale empirical scrutiny, but they *are* intrinsically newsworthy events. Those in the news media need to identify stories that will be of interest to their audience, and cases of police crime typically include storylines that are clearly newsworthy. This project utilized a methodology designed to capitalize on the newsworthy character of police crime, identify these events, and subject them to analyses that have thus far been impossible. Given the previous unavailability of data and the relative absence of empirical studies dedicated to the topic, our work should be considered exploratory. The primary aim was to uncover cases of police crime arrests and to provide the basis for what we hope will become an important contribution to the establishment of a more substantive and useful line of research on the topic.

The remainder of this section is divided into several parts. We initially discuss our findings in terms of both some general observations on the entire data set and selected results within the types of police crime that we believe justify further comment. The second section covers implications for policy and practice. Here, we discuss noteworthy results in regard to the analyses on final adverse employment actions, or the sorts of discipline imposed (if any) by police organizations in cases of police crime. The points on final adverse employment outcomes provides context for the identification and discussion of specific recommendations to law enforcement agencies based on our research. The final section is a discussion on the implications of our study for research.

Discussion of Findings

The identification of notable general observations in regard to the entire data set is complicated by the scope of the study and this report—the research study covers seven calendar years and describes 6,724 criminal cases involving the arrest of 5,545 individual police officers who perpetrated a wide range of criminal acts under varying circumstances. The arrested officers were employed by 2,529 state and local law enforcement agencies (see Appendix D) located in 1,205 counties and independent cities in all 50 states and the District of Columbia. The project has revealed and confirmed at least three comprehensive truths about police crime.

The first general observation is that police crimes are not uncommon. Police officers get arrested for crimes with some regularity in jurisdictions around the nation, including rural areas, small towns, suburbs, and large urban centers. Law enforcement officers in the current study were arrested at a rate of 0.72 officers arrested per 1,000 officers, and at a rate of 1.7 officers arrested per 100,000 population nationwide. Of course, only a small percentage of the total number of law enforcement officers will ever be arrested for a criminal offense, but our data

directly contradicts some of the prevailing assumptions and the proposition that only a small group of rotten apples perpetrate the vast majority of police crime. Those assumptions relate to previous studies, journalistic investigations, and special commissions that described the misconduct of a single and/or handful of rogue officers operating within a single and/or handful of jurisdictions. The assumption that only a small group of rogue officers perpetrate crimes also presumably stems from traditional notions and public expectations regarding the straight-laced, law-abiding police persona. In contrast, our method provided for the identification of an unprecedented number of police crimes that occurred within virtually every sort of place, *and* the opportunity to draw some conclusions about how often these events occur across the nation. The data demonstrate that police crimes are not isolated events, and that hundreds of police officers every year get arrested for crimes including assault, rape, robbery, and murder across the United States.

The second general observation is that police crime is occupationally-derived. That is, the cases identified in our research are largely the product of opportunities and other factors inherent within the context of police work. Scholars have long recognized the occupationally-derived sources of police misconduct, including the reality that patrol officers operate within a context of low supervision, low public visibility, and face-to-face encounters in which officers enjoy considerable power and authority over vulnerable citizens. Our methodology involved the collection of data derived from published news stories that detailed these events rather than summary statistics or official reports, so the research team was able to discern how on-the-job realities contributed to the perpetration of these crimes. For example, the news accounts detailed how the existence of illicit markets for cocaine and face-to-face encounters with drug dealers facilitate opportunities for officers to engage in drug use, shakedown citizens who deal drugs,

and/or deal drugs themselves. The news accounts also describe how this context facilitates and promotes sex-related police crime, whereby police sexually abuse vulnerable citizens they encounter through their work, including young female drivers, prostituted women, or youths involved in police explorer programs. Evidence of the occupationally-derived context of these events is not limited to on-duty crimes. Almost 60% of all of the cases identified in the study occurred when the officer was technically off-duty. The data demonstrate that the source of a significant portion of these so-called off-duty crimes also lies within the context of police work and the perpetrator's role as a police officer, including instances where off-duty officers flash a badge, an official weapon, or otherwise use their power, authority, and the respect afforded to them as a means to commit crime. More broadly, the data show that police crime is not solely or even primarily the product of deviant or defective people; but rather, deviant or defective people who work within an occupational context that provides them unique and unprecedented opportunities to perpetrate crimes whether they are on or off-duty.

The third general observation is that police crime is a complex and multi-dimensional phenomenon both within and across the five types of police crime: alcohol-related, drug-related, sex-related, violence-related, and profit-motivated police crime. The complex and multi-dimensional character of police crime was initially underscored within the context of the Mollen Commission's two-year investigation of drug corruption in New York City during the 1980s and early 1990s. The Commission identified a complex web of relationships among the operation of drug markets, drug corruption, and a long list of associated crimes perpetrated by police. Our data confirmed these observations across jurisdictions throughout the nation; we found that drug-related police crime tends to spawn the perpetration of various other kinds of criminal behavior by police. Perhaps more importantly, both the findings of the Mollen Commission and those of

our own research suggest that the complexity of relationships involved in drug-related police crime extends to other kinds of police crime and the nature of the phenomenon *in general*. For example, the overall complexity of police crime is also demonstrated by the absence of any clearly discernible line between criminal behavior that occurs on- and off-duty. More evidence is provided by the analyses linking police crime arrests to federal civil rights lawsuits. These analyses suggest that at least a portion of those police arrested for a criminal offense are problem officers that exhibit shortcomings in other aspects of the job. Finally, and perhaps most clearly, the multi-dimensional character of police crime is demonstrated within the complex web of statistically significant relationship among variables in our data. For example, Chi-square analyses involving the entire data set identified 90 variables that were significantly associated with conviction, and 120 variables that were significantly associated with job loss. The multivariate analyses identified 16 significant predictors of conviction and 11 significant predictors of job loss. These points demonstrate the difficulties inherent in both the identification of clear-cut explanations of police crime and the interpretation of statistical models designed to isolate these relationships. Perhaps scholarship on the topic needs to start with the premise that recognizes the multivariate complexity of police crime and the difficulties associated with both explaining its etiology; and by extension, the formulation of mitigation strategies.

Sex-related Police Crime

Two points of discussion in regard to the sex-related police crimes include the serious nature of these offenses and the characteristics of the victims. There were a total of 1,475 cases of sex-related police crime that ranged widely in seriousness from peeping tom cases to those that involved murder. Perhaps most notable however is the fact that almost 30% of all the sex-

related cases were classified as cases of police sexual violence. A review of the most serious offenses charged in the cases reveals the serious and often-times egregious nature of these events. There were a total of 422 forcible and statutory rapes, 352 cases of forcible fondling, and 94 sodomy cases. The proportion of cases that involved sexual violence and the most serious kinds of sex-related offenses was larger than expected based on the existing research and the comparative absence of empirical studies on the problem of police sexual violence. The large proportion of serious cases in our data was clearly influenced in part by methodology, since news-based searches probably tend to capture cases that compelled an arrest because they were egregious and could not be ignored. No matter the methodology used to identify them, the sheer number of egregious cases constitutes prima facie evidence that these are not isolated events and should be the subject of additional organizational resources and empirical scrutiny.

The second concern in regard to sex-related crimes is the age of the victims. Children seem to be particularly vulnerable to police who perpetrate sex-related crimes. Almost one-half of the known victims of sex-related crimes were children, and the second-most commonly occurring category in terms of the victim's relationship to the arrested officer was an unrelated child. Certain types of sex crime tend to involve victims who are children, including crimes involving pornography, obscene material, fondling, and promoting the sexual performance of a child.

The sources of sex-related crimes against children are often occupationally derived. For example, the news-based content analyses identified various scenarios in which adults allowed sworn law enforcement officers both access and opportunity to victimize children under their care, presumably because they trusted them. The criminal courts seemed to respond to these cases severely, as a clear majority of the sex-related cases with known dispositions included a

conviction on at least one charge. The likelihood of conviction increased in cases that involved younger victims, suggesting the expression of some form of moral outrage against police who use their power and position to victimize children.

Alcohol-related Police Crime

There were 1,405 cases of alcohol-related police crime identified in the study. There were 960 cases where police were arrested for driving under the influence, and the most serious offense charged in close to 60% of the alcohol-related cases was DUI. Thus, police DUI is the major issue of concern in regard to alcohol-related police crime. The study seems to identify cases where an officer did something that *compelled* an official law enforcement response rather than some type of professional courtesy and non-arrest; there are comparatively few run-of-the-mill cases of DUI in our data. Some of the incident events that accompanied the DUI and seem to have influenced an arrest included a traffic accident, injuries (sometimes fatal), hit-and-run, and refusals to cooperate with BAC and/or field sobriety tests. These cases seemed to compel police action and an arrest because they required some sort of official documentation (e.g., a traffic accident report), included independent witnesses or victims, or were so egregious that police ignored the fact that they involved fellow police officers. Moreover, most of these cases involved a law enforcement agency other than the arrested officer's employer, suggesting that professional courtesies are more likely to occur among police who work together. In many instances, it should be noted however, when an officer was suspected of driving under the influence (and employed by the same agency as the officer conducting the traffic stop or handling a DUI traffic accident investigation), an outside agency was often brought in to conduct field sobriety tests and effectuate the arrest of an intoxicated officer. Police DUI criminal case outcomes seem to be significantly influenced by the geographic location of the case. State

location was the most influential predictor of conviction. State-level reforms of DUI laws obviously influence cases outcomes overall, so it seems likely that legislative changes also influence the disposition of cases of police DUI.

Drug-related Police Crime

There were 739 cases of drug-related police crime. In many ways, our findings both confirm and extend the findings of the Mollen Commission in regard to the etiology and impact of drug-related police crime in New York City several decades ago. For example, while all classes of commonly abused drugs were present, stimulants including cocaine and crack were the most prevalent category of drug involved in these cases. Cocaine was involved in close to one-third of all the drug-related cases; and taken together cocaine and crack were involved in almost 40% of all the drug-related cases. Moreover, cocaine was the strongest predictor for three of six decision trees to predict various forms of drug-related misconduct and crime. We found that—similar to New York City during the 1990s—officers involved in drug-related corruption around the nation often perpetrate various other kinds of crimes including drug trafficking, facilitation of the drug trade, shakedowns, and other forms of theft. Less than one-third of the drug-related cases involved the personal use of drugs by police officers. Our study also seems to suggest the potential for ongoing problems associated with offenses related to opioid analgesics including oxycodone and hydrocodone. More than 20% of all the drug-related cases involved either of these two prescription pain killers. Significant public attention has recently focused on problems related to opioid analgesics, including increases in overdose deaths and prescription violations involving these powerful drugs. Our data suggest that these issues also impact police officers and the nature and character of drug-related police crime.

In terms of criminal case outcomes, police who perpetrate drug-related crimes are significantly more likely to be convicted if the officer ultimately loses their job subsequent to the drug-related arrest. More broadly, we found that job loss predicts conviction in just about every sort of case of police crime, including those that are sex-related, alcohol-related, drug-related, violence-related, and profit-motivated. The two primary outcomes analyzed in this study including criminal case disposition and employment outcome are *not* isolated events. Job loss and conviction influence one another in almost every case of police crime. Job loss provides a context to interpret the perceived need for a criminal conviction and vice versa.

Violence-related Police Crime

There were 3,328 violence-related police crimes identified in the study. These cases involved the most serious types of violent crime including 104 cases of murder or nonnegligent manslaughter and 92 robberies; but, they most commonly involved either a simple assault ($n = 870$) or aggravated assault ($n = 570$). Less than one-half of the violence-related cases are known to have resulted in a criminal conviction on at least one charge. But, if the case also involved the perpetration of a sex-related crime the odds of conviction increase significantly. Moreover, criminal convictions in violence-related police crimes seem to follow patterns that are consistent with those of violent crimes in general. For example, cases of violence-related police crime are significantly less likely to result in conviction if the officer knows the victim. This was also the case for alcohol-related police crimes, suggesting that in some ways court outcomes in cases of police crime are influenced by the same factors that shape court outcomes for any other type of defendant.

Officer-involved domestic violence has become an important topic of concern for scholars and police executives, and there were 961 cases of the officer-involved domestic

violence included within the violence-related police crimes. Conviction on at least one charge is significantly more likely in cases that involve fatal injuries and/or those that involved a violation of a protection order. Other factors that increase the odds of conviction appear to relate to factors other than the specific act of domestic violence, including obstruction, vandalism, or if the case also involves a sex-related offense.

Profit-motivated Police Crime

There were 1,592 cases of profit-motivated police crime identified in the study. There were 46 different offense categories for the *most serious offense charged* in these cases, but the most serious offense charged in about 40% of these cases was unclassified theft, false pretense/swindle, and/or thefts that involved a drug violation. Most of these cases also occurred on the street-level—almost 80% of the profit-motivated crimes were perpetrated by officers in a patrol or other street-level function. Thus, the profit-motivated police crimes in our study more closely resembled the types of thefts perpetrated by traditional street-level criminals rather than business executives, professionals, or other societal elites who are commonly the subject of white-collar crime research. A conviction on at least one criminal charge in the profit-motivated cases depended significantly on whether the case involved a drug-related shakedown. The simple odds of conviction are 109 times greater if a profit-motivated case involved a drug-related shakedown. Similar to other types of police crime, profit-motivated cases that involved an officer who ultimately lost their job were significantly more likely to result in a criminal conviction on at least one charged offense.

Civil Rights Litigation as a Correlate of Police Crime

The study included analyses that involved a cross-check of the names of each of the arrested officers against the master name index in the federal court's PACER system. These

analyses were used to explore whether arrested officers had ever been named in their official capacity as a party defendant in a 42 U.S.C. §1983 federal court civil action at some point during their law enforcement career, and to identify the factors that predict these actions. More broadly, these analyses can be used to identify arrested officers who could potentially be described as problem-prone since the federal lawsuit(s) may be indicative of performance problems in a variety of job-related functions. We are aware of no previous empirical studies that attempt to link the perpetration of police crimes to other forms of misconduct using the PACER database. These types of analyses could potentially lead to new and improved mechanisms to identify and mitigate various forms of police misconduct.

We found that many of the incidents giving rise to the federal court civil actions occurred years or even decades prior to the arrest, and the lawsuits often had nothing to do with the incident that prompted the arrest. Thus, the arrest case and the civil lawsuit(s) potentially indicate the existence of problems across multiple job-related functions, or at least separate instances of the same types of problems over time. The analyses designed to predict being named as a party-defendant in federal court civil actions involving claims pursuant to 42 U.S.C. §1983 seem to indicate at least three important facts. First, officers who are ultimately named as defendants in §1983 federal court civil actions tend to get sued more than once for a variety of civil rights causes of action. These lawsuits are not often isolated events. Second, officers who perpetrate crimes while on-duty are significantly more likely to have been named as a Section 1983 defendant. These are officers whose misconduct tends to occur on-the-job and within their official capacity, so their misdeeds are more likely to be the subject of civil rights litigation and defined as involving a specific denial of a citizen's civil rights acting within their state actor role as a police officer. Third, certain types of police crime tend to predict prior federal civil rights

litigation. Many of these predictors seemed to be acts that were predatory or at least in some ways violent or aggressive, including crimes involving cocaine, murder, non-negligent manslaughter, kidnapping/abduction, and cases of family violence. More research focused on the link between police crime and prior federal civil rights litigation is obviously necessary in order to more fully identify, describe, and explore these relationships.

Implications for Policy and Practice

Mechanisms designed to identify and mitigate police misconduct include those that originate both internal and external to the law enforcement organization. External controls include local government, citizen review boards, the media, civil lawsuits, and the criminal courts among others. These external controls clearly maintain certain advantages in terms of the identification and mitigation of police misconduct. For example, the media often serves to identify potential cases of misconduct. Likewise, local governments can and often do influence the budget of law enforcement agencies. So too, civilian review boards have the potential to integrate citizens and grass-roots organizations into the process of police discipline and reform. The various external controls, however, do share some problems. Civilian review of the street-level decisions of sworn law enforcement officers may engender a loss of trust and hesitancy in situations that require immediate judgments. Likewise, street-level law enforcement officers will probably mistrust any sort of external control. Also, external controls are in most cases limited because they do not exert direct control over the policies and disciplinary processes of state and local law enforcement organizations.

Internal mechanisms to control police misconduct originate from within each law enforcement organization and primarily involve strategies to develop professionalism through hiring and training; and, the creation, maintenance, and enforcement of procedures and rules that

comprise much of the bureaucracy of the police organization. The advantages of internal controls are clear: members of the organization including law enforcement executives, first-line supervisors, and internal affairs units are likely in the best position to identify and punish most types of police crime. Thus, one of the primary goals of our research was to determine the degree to which state and local law enforcement organizations identify and respond to cases of police crime. These data are substantive in terms of policy and practice because they provide a point of reference in terms of how frequently agencies identify police crimes through an arrest and opportunities to assess the typical discipline imposed by law enforcement organizations in these cases—and ultimately, the basis upon which to devise strategies to improve the internal control of police misconduct.

Our data indicate that in most cases of police crime the arrest is made by a law enforcement agency *other than* the officer's employing agency. Two-thirds of the 6,724 police crime arrest cases originated from an arrest made by an agency other than the employing agency. Why do employing law enforcement agencies often fail to make the arrest in cases of police crime? The content analyses identified clear cases in which the employing agency should have made the arrest and failed to do so. Policing scholars have always recognized that police do not typically arrest other police officers. Sworn officers are likely to use their discretion and extend a *professional courtesy* to other law enforcement officers, especially co-workers or in some cases their close friends. These kinds of cases represent a failure of internal control and demonstrate what has sometimes been referred to as a *fox in the henhouse* problem, one that illustrates the need for some type of external controls of police misconduct and crime. On the other hand, the low proportion of arrests made by the employing agency may also be legitimate. For example, officers in many cases do not live within the jurisdictions they police, or they may live within the

jurisdiction but choose to perpetrate their crimes elsewhere. The content analyses also identified many arrest cases in which law enforcement executives purposively contacted other state and local law enforcement agencies to investigate suspected police crimes or arrest one of their own sworn officers to promote objectivity and limit the potential for bias in the investigation.

Clearly, determinations in regard to whether agencies can be relied upon to identify cases and the overall effectiveness of internal mechanisms of control in this regard cannot be made solely on the basis of whether the employing agency made the arrest in a case of police crime.

The ultimate internal control involves the imposition of progressive discipline and final adverse employment outcomes, including reassignment, suspension, resignation, and termination from the job. Very little is known about the operation of internal mechanisms of control and the imposition of adverse employment outcomes in cases of police crime beyond perhaps studies focused on a single police agency. The next part of this section is a discussion on the imposition of adverse employment outcomes in terms of both the entire data set and selected results within the types of police crime that we believe justify further comment. We then provide specific recommendations to law enforcement agencies based on some of these findings.

Overall, sworn state and local law enforcement officers are known to have lost their job as a result of the arrest in slightly more than one-half of the cases (54%). Clearly, law enforcement organizations do not automatically terminate sworn officers who perpetrate crimes. The organizational response to police crime varies rather widely across alcohol-related, drug-related, sex-related, violence-related, and profit-motivated police crime. An arrest in and of itself matters much less than the type of underlying criminal behavior that prompted the arrest. For example, sworn law enforcement officers were known to have lost their job as a result of an arrest in only 38% of the alcohol-related cases, while officers were known to have lost their job

as a result of the arrest in 72% of the sex-related cases and 70% of the drug-related cases. The percentage of cases in which officers were known to have lost their jobs for violence-related and profit-motivated cases was in between these extremes (53% and 68% respectively). The odds of job loss decreased among drug-related cases when those cases also included an alcohol-related offense. Differential rates of job loss across types of police crime may reflect perceptions of threats to organizational legitimacy or degrees of outrage that vary considerably across crime types. For example, cases involving police sexual violence (i.e., both sex- and violence-related police crime) are significantly more likely to result in job loss than other types of police crime. Other specific types of police crime are significantly less likely to result in job loss, including drug-related crimes that involve marijuana and crimes of family violence. The comparatively low rate at which family violence crimes result in job loss seems particularly troubling given the fact that persons convicted of a qualifying misdemeanor crime of domestic violence—including sworn law enforcement officers—are prohibited from possessing any firearm or ammunition pursuant to the Lautenberg Amendment (1996).

More broadly, the data clearly demonstrate that the imposition of adverse employment outcomes in cases of police crime is not an isolated event and depends upon other factors that provide a meaningful context to these decisions and shape the perceptions of law enforcement administrators and their determinations about appropriate levels of discipline. The most obvious of the contextual factors that influence the likelihood of job loss is the imposition of other forms of organizational discipline. State and local law enforcement organizations are significantly less likely to separate (through involuntary termination or voluntary resignation) sworn officers from the job who have instead been suspended and/or re-assigned as a result of an arrest. The operation of external mechanisms of control also influences organizational decisions on whether

or not to terminate the employment of arrested sworn officers, specifically criminal court dispositions and whether or not an officer had been sued in federal court for a civil rights violation. The odds that an officer will lose his or her job significantly increase if they are criminally convicted on at least one charged offense associated with the arrest. Law enforcement agencies are likely to view the conviction as a confirmation of both the criminal act and a degree of public condemnation that is impossible to dismiss or ignore. Likewise, law enforcement organizations clearly consider federal litigation and charges of other civil rights violations over the course of the career as a context relevant to determining whether the arrestee is a problem-prone officer who is more trouble than he or she is worth to the organization. Law enforcement administrators and scholars interested in determining effective organizational responses to police misconduct and crime need to recognize organizational discipline as a multivariate phenomenon that should be interpreted within the context of other forms of control.

Decisions in regard to adverse employment outcomes also seem to depend on the degree to which the arrested officer was engaged in his or her official role as a police officer at the time of the arrest. For example, the odds of job loss in cases involving alcohol-related crimes significantly increased if the officer was on-duty, and the odds of job loss significantly increased in cases involving sex-related crime and profit-motivated crime if the officer was acting in his or her official capacity. Criminal behavior that occurs on-duty and/or while an officer is acting in his or her official capacity relates more directly to the job and poses more significant threats to organizational legitimacy; and hence, tends to increase the likelihood that severe penalties will be imposed in any particular case of police crime.

Finally, the likelihood of job loss sometimes depends on the closely associated factors of agency size and the character of the jurisdiction, particularly for cases that involve either alcohol

and/or drugs. For example, cases that involve alcohol-related crimes are significantly more likely to result in job loss as the size of the employing police agency decreases. Likewise, cases that involve drug-related crime are significantly more likely to result in job loss when they occur in non-metropolitan counties. Sworn law enforcement officers who perpetrate these types of crimes seem to be more vulnerable to the most punitive employment outcomes when they work in smaller police agencies located within nonmetropolitan jurisdictions than officers who patrol big-city beats. Crimes such as police DUI and or small-scale drug use are probably much more newsworthy and difficult to ignore when they occur in small towns or rural jurisdictions. On the other hand, these types of police crime may be less likely to be defined as a big deal by law enforcement executives and residents who live in large metropolitan areas. Officers employed by large urban law enforcement agencies may also in some ways be protected from the most severe penalties by the complexity of large bureaucratic structures and/or more intricate disciplinary procedures.

The points on final adverse employment outcomes provide context for the identification and discussion of specific recommendations to law enforcement agencies based on our research. Our first and perhaps most salient general observation about the data was that police crimes are not uncommon and that they occur with some regularity in jurisdictions across the nation. The sheer number of police crimes directly contradicts the presumption that they are perpetrated by a small cadre of problem-prone officers; and, the fact that roughly two-thirds of all the cases originated from an arrest made by an agency other than the employing agency reveals that in at least some cases agencies are not aware of the crimes perpetrated by their own officers. State and local law enforcement organizations routinely compel applicants to disclose criminal arrests or orders of protection against them during pre-employment screening. Clearly, these

requirements need to be extended to all on-the-job sworn employees to compel them to disclose any criminal arrests or orders of protection so that police agencies can document and respond to known cases of police crime. Strategies to mitigate police crime cannot succeed without identification, and our research demonstrates the problems associated with the omission of obvious and necessary policies to compel the disclosure of criminal arrests and protection orders.

Relatedly, state and local law enforcement organizations need to conduct routine annual criminal background checks of every sworn officer. Annual criminal background checks serve two primary purposes. First, they provide an additional check necessary to ensure compliance with self-report procedures outlined above and to identify cases in which officers fail to disclose arrests, convictions, or orders of protection lodged against them. Second, annual criminal background checks would increase compliance with the requirements of the Lautenberg Amendment (1996). Our data on sworn law enforcement officers arrested for crimes associated with domestic violence demonstrates how some officers escape appropriate penalties, and maintain their law enforcement job that requires them to carry a firearm. The problem stems at least in part from the absence of any central registry or database of persons convicted of misdemeanor crimes of domestic violence. Law enforcement agencies should require annual criminal background checks to ensure the identification and documentation of police crimes within the organization and to maintain compliance with federal law designed to protect victims of family violence—especially in cases where the abuser is among those expected to enforce domestic violence statutes.

We found that the organizational response to police crime varies rather widely across jurisdictions, and that law enforcement agencies do not automatically terminate officers who perpetrate crimes. These disparities likely relate to a host of factors associated with

organizational characteristics, characteristics of the offense(s), and the need to consider disciplinary actions within the unique context of each individual case of police crime. So too, many state and local law enforcement agencies operate under terms of a collective bargaining agreement that structures organizational responses and acceptable forms of progressive discipline and imposition of adverse employment outcomes. However in most cases, law enforcement executives would benefit from some sort of formalized procedures designed to guide disciplinary decisions and organizational responses to police crimes within the ranks. The guidelines would necessarily be broad in scope and allow a degree of administrative discretion and case-by-case consideration, but their existence would at the least ensure that some type of process is in place and contribute to both regularity and consistency of organizational responses over time.

Finally, state and local law enforcement agencies should move toward the integration of data on police crimes within existing systems designed to increase accountability as well as those intended to provide practical assistance to sworn law enforcement officers both on and off the job. Many law enforcement agencies have already implemented comprehensive personnel assessment systems that collect a wide range of data and have the means to address a broad range of problems, most commonly misconduct related to the use of force and citizen complaints. These early intervention systems need to include the collection of data on the criminal arrests of sworn law enforcement officers, because we know that police crimes occur with some regularity and that their occurrence can in some cases be used as an indicator of problems in other areas of the job. More bluntly, systems designed to provide an early warning of officers who are problem-prone cannot be considered complete if they are unable to identify sworn law enforcement officers who have perpetrated a criminal offense.

Employee Assistance Programs (EAPs) could also utilize data on criminal arrests of sworn law enforcement officers to identify and target officers who need help. These programs typically provide personal and job-related counseling services. Police crime arrests are an obvious indicator of the need for services to address a host of occupationally-derived problems including psychological and mental health issues related to violence exposure, trauma, post-traumatic stress disorder, substance abuse, job-related stress, and work-family spillover effects. This is especially true for sworn law enforcement officers who are combat veterans of the military. In this regard, the content analyses revealed numerous arrest cases that were obviously part of a much wider milieu and the build-up of long-term stressors—the proverbial tip of an iceberg of job-related and personal crises that can in some cases lead to complete psychological breakdowns that produce catastrophic consequences for the officer and his or her victims. These events and unraveling can occur across the life course of any sworn law enforcement officer's career. Law enforcement agencies need to identify police crimes so they can use the information to help officers who obviously need it and refer them to programs designed to provide practical and in some cases life-saving assistance to them.

Implications for Further Research

The current research project identified and analyzed an unprecedented amount of data on the arrests of nonfederal sworn law enforcement officers in the United States. The research data collection methodology was designed by Stinson (2009) and allows for the aggregation of information on the phenomenon of police crime that would not otherwise been possible (Payne, 2013). It would also be very difficult to process and code the content of the vast amount of raw data analyzed in the current project without sophisticated database resources. The project is supported by OnBase, an enterprise content management (ECM) database system. Originally the

research team utilized OnBase solely to archive digital image files of all the paper-based news articles, court records, and coding sheets that were collected and analyzed by Stinson and colleagues as part of their research on police crime. Over the past several years Stinson has enhanced the project database with additional electronic files, including video files, audio files, and the ability to search the full text of all the digital images contained in the project's digital imaging database. Appendix E presents an entity relationship of Stinson's police crime database.

Several database components were added to the project ECM database to support the current study, including an object-relational database that allows for data to be organized in tables (a relational database component), as well as seamless integration with the digital imaging and video files (an object-oriented database component) among others. Coding of content was completed with a customized PC-based coding instrument using the IBM/SPSS Data Collection software application. The coding instrument system pulls case-specific data from the relational database into the on-screen coding instrument for each case to be coded, thus reducing coder duplication of effort and the potential for coding errors. The data from the completed coding instrument for each case is converted to an SPSS data file for subsequent statistical analyses, and data files are also converted to an electronic coding sheet in an MS Word (a facsimile of our paper-based coding instrument) and indexed in OnBase with other case-specific electronic files.

The data collection methodology and ECM research project database design deployed in the current study can serve as an integrated model for other social science research projects utilizing big data in a variety of structured and unstructured paper-based and electronic formats. Most large research universities already utilize ECM database systems for nonresearch applications (including admissions, operations, and administrative functions). These ECM database systems could be made available to faculty researchers for database development in

large-scale content analysis research projects and other research methodologies. Similarly, OnBase and other ECM database systems are often utilized by federal, state, and local government agencies, including courts and law enforcement agencies. The costs of making such systems available to research teams for research database projects would be *de minimis* when the ECM system is already deployed for other uses within an organization.

Stinson and colleagues continue to collect data on the criminal arrests of sworn law enforcement officers at state and local law enforcement agencies across the United States at a rate of approximately 1,100 new arrest cases involving approximately 800-950 sworn law enforcement officers arrested annually. The project ECM database now includes 11,131 criminal arrest cases (as of this writing, for the eleven year period January 2005 through December 2015) involving the arrests of 9,391 individual sworn law enforcement officers who were employed by 3,666 nonfederal state and local law enforcement officers located in 1,543 counties and independent cities in all 50 states and the District of Columbia. The research team plans to continue with the research project as a longitudinal trend study of police crime in the United States.

We hope that the products disseminated from this study (and our larger project on police crime research) serve as a starting point for the research projects of other scholars and student researchers. An electronic copy of the data set (together with supporting documentation) for the current study will be deposited in SPSS portable files with the National Archives of Criminal Justice Data (NACJD) at the Inter-university Consortium for Political and Social Research (ICPSR).

REFERENCES

- Abdollahi, M. K. (2002). Understanding police stress research. *Journal of Forensic Psychology Practice*, 2(2), 1–24. http://doi.org/10.1300/J158v02n02_01
- Alpert, G. P., & MacDonald, J. M. (2001). Police use of force: An analysis of organizational characteristics. *Justice Quarterly*, 18(2), 393–409.
<http://doi.org/10.1080/07418820100094951>
- Alpert, G. P., & Smith, M. R. (1999). Police use of force data: Where we are and where we should be going. *Police Quarterly*, 2(1), 57–78.
<http://doi.org/10.1177/109861119900200103>
- Anechiarico, F., & Jacobs, J. B. (1996). *The pursuit of absolute integrity: How corruption control makes government ineffective*. Chicago, IL: The University of Chicago Press.
- Anshel, M. H. (2000). A Conceptual Model and Implications for Coping with Stressful Events in Police Work. *Criminal Justice and Behavior*, 27(3), 375–400.
<http://doi.org/10.1177/0093854800027003006>
- Ayres, R. M., Flanagan, G. S., & Ayres, M. B. (1992). *Preventing law enforcement stress: The organization's role* (No. NCJ 141934). Washington, DC: U.S. Department of Justice, Office of Justice Programs, Bureau of Justice Assistance.
- Baer, Jr., H., & Armao, J. P. (1995). The Mollen Commission report: An overview. *New York Law School Law Review*, 40(1-2), 73–85.
- Banton. (1964). *The policemen in the community*. New York, NY: Basic Books.
- Barak, G. (1995). Media, Society, and Criminology. In *Media, process, and the social construction of crime: Studies in newsmaking criminology* (pp. 3–45). New York, NY: Garland.

- Barker, T. (1978). An empirical study of police deviance other than corruption. *Journal of Police Science and Administration*, 6(3), 264–272.
- Barker, T., & Carter, D. L. (1994). A typology of police deviance. In T. Barker & D. L. Carter (Eds.), *Police deviance* (3rd ed., pp. 3–11). Cincinnati, OH: Anderson.
- Barton, G. (2011, October 25). Milwaukee police often face minimal punishment for driving drunk. *Journal Sentinel*. Milwaukee, WI.
- Bayley, D. H., & Garofalo, J. (1989). The management of violence by police patrol officers. *Criminology*, 27(1), 1–26. <http://doi.org/10.1111/j.1745-9125.1989.tb00861.x>
- Begg, D. J., Langley, J. D., & Stephenson, S. (2003). Identifying factors that predict persistent driving after drinking, unsafe driving after drinking, and driving after using cannabis among young adults. *Accident; Analysis and Prevention*, 35(5), 669–675. [http://doi.org/10.1016/S0001-4575\(02\)00045-3](http://doi.org/10.1016/S0001-4575(02)00045-3)
- Bewick, V., Cheek, L., & Ball, J. (2004). Statistics review 13: Receiver operating characteristic curves. *Critical Care*, 8(6), 508–512. <http://doi.org/10.1186/cc3000>
- Bharat, K. (2012, September 22). Google News turns 10. Retrieved from <http://googlenewsblog.blogspot.com/2012/09/google-news-turns-10.html>
- Binder, A., & Scharf, P. (1982). Deadly force in law enforcement. *Crime & Delinquency*, 28(1), 1–23. <http://doi.org/10.1177/001112878202800101>
- Bittner, E. (1978). The functions of the police in modern society. In *Policing: A view from the street* (pp. 32–50). Santa Monica, CA: Goodyear.
- Black, D. J., & Reiss, A. J. (1967). *Studies of crime and law enforcement in major metropolitan areas* (Vol. 2, Field surveys III. Section I: Patterns of behavior in police and citizen transactions). Washington, DC: U.S. Government Printing Office.

- Blumberg, M. (1983). *The use of firearms by police officers: The impact of individuals, communities, and race*. State University of New York, Albany, NY. Retrieved from <http://0-proquest.umi.com.maurice.bgsu.edu/pqdweb?did=753184011&sid=1&Fmt=2&clientId=3340&RQT=309&VName=PQD>
- Blumenstein, L., Fridell, L., & Jones, S. (2012). The link between traditional police sub-culture and police intimate partner violence. *Policing: An International Journal of Police Strategies & Management*, 35(1), 147–164. <http://doi.org/10.1108/13639511211215496>
- Box, S. (1983). *Power, crime, and mystification*. London: Routledge.
- Breiman, L., Friedman, J. H., Olshen, R. A., & Stone, C. J. (1984). *Classification and regression trees*. Belmont, CA: Wadsworth.
- Carlson, M. (2007). Order versus access: News search engines and the challenge to traditional journalistic roles. *Media, Culture & Society*, 29(6), 1014–1030. <http://doi.org/10.1177/0163443707084346>
- Carter, D. L. (1990a). An overview of drug-related misconduct of police officers: Drug abuse and narcotic corruption. In *Drugs, crime, and the criminal justice system* (pp. 79–109). Cincinnati, OH: Anderson.
- Carter, D. L. (1990b). Drug-related corruption of police officers: A contemporary typology. *Journal of Criminal Justice*, 18(2), 85–98. [http://doi.org/10.1016/0047-2352\(90\)90028-A](http://doi.org/10.1016/0047-2352(90)90028-A)
- Carter, D. L., & Stephens, D. W. (1994). An overview of issues concerning police officer drug use. In T. Barker & D. L. Carter (Eds.), *Police deviance* (3rd ed., pp. 101–122). Cincinnati, OH: Anderson.

- Castaneda, R. (2008, December 17). DUI arrest is officer's 4th this year: Prince George's lieutenant allegedly asleep behind the wheel. *Washington Post*, p. B1.
- Cheh, M. M. (1996). Are lawsuits an answer to police brutality? In W. A. Geller & H. Toch (Eds.), *Police violence: Understanding and controlling police abuse of force* (pp. 247–272). New Haven, CT: Yale University Press.
- Chermak, S. M., McGarrell, E., & Gruenewald, J. (2006). Media coverage of police misconduct and attitudes toward police. *Policing: An International Journal of Police Strategies & Management*, 29(2), 261–281. <http://doi.org/10.1108/13639510610667664>
- Chou, S. P., Dawson, D. A., Stinson, F. S., Huang, B., Pickering, R. P., Zhou, Y., & Grant, B. F. (2006). The prevalence of drinking and driving in the United States, 2001–2002: Results from the national epidemiological survey on alcohol and related conditions. *Drug and Alcohol Dependence*, 83(2), 137–146. <http://doi.org/10.1016/j.drugalcdep.2005.11.001>
- Christopher Commission. (1991). *Report of the Independent Commission on the Los Angeles Police Department*. Los Angeles, CA: City of Los Angeles.
- Collins, A. (1998). *Shielded from justice: Police brutality and accountability in the United States*. New York, NY: Human Rights Watch.
- Commission to Combat Police Corruption. (1998a). *The New York City Police Department's disciplinary system: How the department disciplines its members who engage in serious off-duty misconduct*. New York: The City of New York.
- Commission to Combat Police Corruption. (1998b). *Third annual report to the Commission*. New York, NY: The City of New York.
- Commission to Combat Police Corruption. (2001a). *Fifth annual report of the Commission*. New York: The City of New York.

- Commission to Combat Police Corruption. (2001b). *Sixth annual report of the Commission*. New York: The City of New York.
- Commission to Combat Police Corruption. (2004). *Seventh annual report of the Commission*. New York, NY: The City of New York.
- Commission to Combat Police Corruption. (2009). *Eleventh annual report to the Commission*. New York, NY: The City of New York.
- Commission to Combat Police Corruption. (2010). *Twelfth annual report of the Commission*. New York: The City of New York.
- Davis, A. C. (2008, December 20). Officer TASERed in one of four DUI incidents: Prosecutors dropped some charges. *Washington Post*, p. B3.
- De'ath, G., & Fabricius, K. E. (2000). Classification and regression trees: A powerful yet simple technique for ecological data analysis. *Ecology*, *81*(11), 3178–3192.
[http://doi.org/10.1890/0012-9658\(2000\)081\[3178:CARTAP\]2.0.CO;2](http://doi.org/10.1890/0012-9658(2000)081[3178:CARTAP]2.0.CO;2)
- Denno, D. W. (1993). Perspectives on disclosing rape victims' names. *Fordham Law Review*, *61*(5), 1113–1131.
- Dension, D. G. T., Mallick, B. K., & Smith, A. F. M. (1998). A Bayesian CART algorithm. *Biometrika*, *85*(2), 363–377. <http://doi.org/10.1093/biomet/85.2.363>
- Dietrich, J. F., & Smith, J. (1986). The nonmedical use of drugs including alcohol among police personnel: A critical literature review. *Journal of Police Science and Administration*, *14*(4), 300–306.
- Dishlacoff, L. (1976). The drinking cop. *Police Chief*, *43*(1), 32–39.

- Dolan, M. C., & Doyle, M. (2000). Violence risk prediction: Clinical and actuarial measures and the role of the Psychopathy Checklist. *The British Journal of Psychiatry*, *177*(4), 303–311. <http://doi.org/10.1192/bjp.177.4.303>
- Fazlollah, M. (2001, March 25). How a top cop drank, drove, crashed and covered it up. *The Philadelphia Inquirer*, p. A1. Philadelphia, PA.
- Fazlollah, M. (2003, November 4). Captain involved in flap to head to 8th district. *The Philadelphia Inquirer*. Philadelphia, PA.
- Fennell, M. L., Rodin, M. B., & Kantor, G. K. (1981). Problems in the work setting, drinking, and reasons for drinking. *Social Forces*, *60*(1), 114–132.
- Fishman, J. E. (1978). *Measuring police corruption*. [Monograph]. New York: John Jay College of Criminal Justice, Criminal Justice Center.
- Foster, G. P. (1966). *Police administration and the control of police criminality: A case study approach*. University of Southern California, Los Angeles. Retrieved from <http://proquest.umi.com/pqdweb?did=757948991&sid=1&Fmt=1&clientId=63512&RQT=309&VName=PQD>
- Frank, J., Novak, K. J., & Smith, B. W. (2001). *Street-level policing in Cincinnati: The content of community and traditional policing and the perceptions of policing audiences* (No. NCJ No. 194131) (p. 236). Washington, DC: U.S. Department of Justice, Office of Justice Programs, National Institute of Justice.
- Fyfe, J. J. (1980). Always prepared: Police off-duty guns. *Annals of the American Academy of Political and Social Science*, *452*, 72–81. <http://doi.org/10.1177/000271628045200108>
- Fyfe, J. J. (1981). Observations on police deadly force. *Crime & Delinquency*, *27*, 376–389. <http://doi.org/10.1177/001112878102700305>

- Fyfe, J. J. (1987). Police shooting: Environment and license. In *Controversial issues in crime and justice* (pp. 79–94). Newbury Park, CA: Sage.
- Fyfe, J. J. (1988). Police use of deadly force: Research and reform. *Justice Quarterly*, 5(2), 165–205. <http://doi.org/10.1080/07418828800089691>
- Fyfe, J. J., & Kane, R. J. (2006). *Bad cops: A study of career-ending misconduct among New York City police officers*. (NCJ No. 215795). Washington, DC: U.S. Department of Justice, National Institute of Justice.
- Garner, J. H., Maxwell, C. D., & Heraux, C. J. (2002). Characteristics associated with the prevalence and severity of force used by the police. *Justice Quarterly*, 19(4), 705–746. <http://doi.org/10.1080/07418820200095401>
- Garrity v. New Jersey, 385 U.S. 493 (1967).
- Gershon, R. (2000). *Project shields: Final Report* (No. NCJ 185892). Washington, DC: U.S. Department of Justice, Office of Justice Programs, National Institute of Justice. Retrieved from <https://www.ncjrs.gov/pdffiles1/nij/grants/185892.pdf>
- Gorta, A. (2009). Illegal drug use by police officers: Using research and investigations to inform prevention strategies. *International Journal of Police Science & Management*, 11(1), 85–96. <http://doi.org/10.1350/ijps.2009.11.1.112>
- Greene-Forsythe, C. L. (2000). Precursors of physical domestic violence in police families: Lessons from intensive psychotherapy of participants and investigating officers. In D. C. Sheehan (Ed.), *Domestic violence by police officers: A compilation of papers submitted to the Domestic Violence by Police Officers Conference at the FBI Academy, Quantico, VA* (pp. 163–180). Washington, DC: U.S. Department of Justice, Federal Bureau of Investigation.

- Greene, J. R., Piquero, A. R., Hickman, M. J., & Lawton, B. A. (2004). *Police integrity and accountability in Philadelphia: Predicting and assessing police misconduct*. (NCJ No. 207823). Washington, DC: U.S. Department of Justice, National Institute of Justice.
- Griffin, S. P., & Bernard, T. J. (2003). Angry aggression among police officers. *Police Quarterly*, 6(1), 3–21. <http://doi.org/10.1177/1098611102250365>
- Harris, C. J. (2009). Exploring the relationship between experience and problem behaviors: A longitudinal analysis of officers from a large cohort. *Police Quarterly*, 12(2), 192–213. <http://doi.org/1098611108327314v1>
- Harris, C. J. (2011a). Problem behaviors in later portions of officers' careers. *Policing: An International Journal of Police Strategies & Management*, 34(1), 135–152. <http://doi.org/10.1108/13639511111106650>
- Harris, C. J. (2011b). The relationship between career pathways of internal and citizen complaints. *Police Quarterly*, 14(2), 142–165. <http://doi.org/10.1177/10986111111404141>
- Harris, C. J. (2012). The residual career patterns of police misconduct. *Journal of Criminal Justice*, 40(4), 323–332. <http://doi.org/10.1016/j.jcrimjus.2012.06.010>
- Harris, D. A. (1997). Driving while black and all other traffic offenses: The Supreme Court and pretextual traffic stops. *Journal of Criminal Law and Criminology*, 87(2), 544–582.
- Harris, D. A. (1999). The stories, the statistics, and the law: Why “driving while black” matters. *University of Minnesota Law Review*, 84(2), 265–326.
- Hayes, A. F., & Krippendorff, K. (2007). Answering the call for a standard reliability measure for coding data. *Communication Methods and Measures*, 1(1), 77–89. <http://doi.org/10.1080/19312450709336664>

- Hingson, R., Mangione, T., & Barrett, J. (1981). Job characteristics and drinking practices in the Boston metropolitan area. *Journal of Studies on Alcohol and Drugs*, 42(9), 725–738.
- Hurrell, Jr., J. J., Pate, A., Kliesmet, R., Bowers, R. A., Lee, S., & Burg, J. A. (1984). *Stress among police officers*. Cincinnati, OH: US Department of Health and Human Services, Public Health Service, Centers for Disease Control, National Institute for Occupational Safety and Health, Division of Biomedical and Behavioral Science.
- International Association of Chiefs of Police. (2003). *Discussion paper on IACP's police on domestic violence by police officers: A product of the IACP Police Response to Violence Against Women Project*. Alexandria, VA: International Association of Chiefs of Police. Retrieved from <http://www.theiacp.org/LinkClick.aspx?fileticket=NzsLwlSvR2g%3d&tabid=87>
- Johnson, L. B. (1991). On the Front Lines: Police Stress and Family Well-Being. In *Hearings before the Select Committee on Children, Youth, Families, House of Representatives, 102 Congress, First Session* (pp. 32–48). Washington, DC: U.S. Government Printing Office.
- Johnson, L. B., Todd, M., & Subramanian, G. (2005). Violence in police families: Work-family spillover. *Journal of Family Violence*, 20(1), 3–12. <http://doi.org/10.1007/s10896-005-1504-4>
- Jupp, V. R., Davies, P., & Francis, P. (1999). The features of invisible crime. In *Invisible crimes: Their victims and their regulation* (pp. 1–28). London: Macmillan.
- Kane, R. J. (2007). Collect and release data on coercive police actions. *Criminology & Public Policy*, 6(4), 773–780. <http://doi.org/10.1111/j.1745-9133.2007.00485.x>

- Kane, R. J., & White, M. D. (2009). Bad cops: a study of career-ending misconduct among New York City police officers. *Criminology & Public Policy*, 8(4), 737–769.
<http://doi.org/10.1111/j.1745-9133.2009.00591.x>
- Kane, R. J., & White, M. D. (2013). *Jammed up: Bad cops, police misconduct, and the New York City Police Department*. New York, NY: New York University Press.
- Kappeler, V. E., Sluder, R. D., & Alpert, G. P. (1998). *Forces of deviance: Understanding the dark side of policing*. Long Grove, IL: Waveland Press.
- Kass, G. V. (1980). An exploratory technique for investigating large quantities of categorical data. *Applied Statistics*, 29(2), 119–127.
- Klockars, C. B. (1996). A theory of excessive force and its control. In W. A. Geller & H. Toch (Eds.), *Police violence: Understanding and controlling police abuse of force* (pp. 1–22). New Haven, CT: Yale University Press.
- Klockars, C. B., Kutnjak Ivkovic, S., & Haberfield, M. R. (2006). *Enhancing police integrity*. New York, NY: Springer.
- Klockars, C. B., Kutnjak Ivkovic, S., Harver, W. E., & Haberfield, M. R. (1997). *Measurement of police integrity, final report*. (NCJ No. 171654). Washington, DC: U.S. Department of Justice, Office of Justice Programs, National Institute of Justice.
- Klockars, C. B., Kutnjak Ivkovic, S., Harver, W. E., & Haberfield, M. R. (2000). *The measurement of police integrity* (No. NCJ 181465). Washington, DC: U.S. Department of Justice, Office of Justice Programs, National Institute of Justice.
- Knapp Commission. (1972). *Commission to Investigate Allegations of Police Corruption and the City's Anti-Corruption Procedures: The Knapp Commission report on police corruption* (p. 283). New York, NY: George Braziller.

- Kohan, A., & O'Connor, B. P. (2002). Police officer job satisfaction in relation to mood, well-being, and alcohol consumption. *Journal of Psychology, 136*(3), 307–319.
<http://doi.org/10.1080/00223980209604158>
- Kraska, P. B., & Kappeler, V. E. (1988). Police on-duty drug use: A Theoretical and descriptive examination. *American Journal of Police, 7*(1), 1–28.
- Kraska, P. B., & Kappeler, V. E. (1995). To serve and pursue: Exploring police sexual violence against women. *Justice Quarterly, 12*(1), 85–111.
<http://doi.org/10.1080/07418829500092581>
- Krippendorff, K. (2013). *Content analysis: An introduction to its methodology* (3rd ed.). Los Angeles, CA: Sage.
- Kutnjak Ivkovic, S. (2003). To serve and collect: Measuring police corruption. *The Journal of Criminal Law & Criminology, 93*(2-3), 593–650.
- Kutnjak Ivkovic, S. (2005). *Fallen blue knights: Controlling police corruption*. New York: Oxford University Press.
- LaFree, G. (1989). *Rape and criminal justice: The social construction of sexual assault*. Belmont, CA: Wadsworth.
- LaFree, G., & Dugan, L. (2007). Introducing the Global Terrorism Database. *Terrorism and Political Violence, 19*, 181–204. <http://doi.org/10.1080/09546550701246817>
- Lautenberg Amendment. Gun Ban for Individuals Convicted of a Misdemeanor Crime of Domestic Violence, Pub. L. No. P.L. 104-208, §658 (1996).
- Lawrence, R. C. (2000). *The politics of force: Media and the construction of police brutality*. Berkeley, CA: University of California Press.

- Leino, T., Eskelinen, K., Summala, H., & Virtanen, M. (2011). Work-related violence, debriefing and increased alcohol consumption among police officers. *International Journal of Police Science & Management*, *13*(2), 149–157.
<http://doi.org/10.1350/ijps.2011.13.2.229>
- Lersch, K. M., & Feagin, J. R. (1996). Violent police-citizen encounters: An analysis of major newspaper accounts. *Critical Sociology*, *22*(2), 29–49.
<http://doi.org/10.1177/089692059602200202>
- Lersch, K. M., & Mieczkowski, T. (2005a). Drug testing sworn law enforcement officers: One agency's experience. *Journal of Criminal Justice*, *33*(3), 289–297.
<http://doi.org/10.1016/j.jcrimjus.2005.02.008>
- Lersch, K. M., & Mieczkowski, T. (2005b). Violent police behavior: Past, present, and future research directions. *Aggression and Violent Behavior*, *10*(5), 552–568.
<http://doi.org/10.1016/j.avb.2004.10.002>
- Liederbach, J. (2005). Addressing the “elephant in the living room”: An observational study of the work of suburban police. *Policing: An International Journal of Police Strategies & Management*, *28*(3), 415–434. <http://doi.org/10.1108/13639510510614537>
- Liederbach, J., Boyd, L. M., Taylor, R. W., & Kawucha, S. K. (2007). Is it an inside job? An examination of internal affairs complaint investigation files and the production of nonsustained findings. *Criminal Justice Policy Review*, *18*, 353–377.
<http://doi.org/10.1177/0887403407303799>
- Liederbach, J., & Frank, J. (2003). Policing Mayberry: The work routines of small-town and rural officers. *American Journal of Criminal Justice*, *28*(1), 53–72.
<http://doi.org/10.1007/BF02885752>

- Lindsay, V., & Shelley, K. (2009). Social and stress-related influences of police officers' alcohol consumption. *Journal of Police and Criminal Psychology, 24*, 87–92.
<http://doi.org/10.1007/s11896-009-9048-9>
- Lonsway, K. A., & Harrington, P. (2003). Model policy for officer domestic violence. *Law & Order, 51*(10), 141–149.
- Los Angeles Police Department. (2000). *Board of inquiry into the Rampart area corruption incident, public report*. Los Angeles, CA: City of Los Angeles. Retrieved from http://www.lapdonline.org/assets/pdf/boi_pub.pdf
- Lundman, R. J., & Fox, J. C. (1978). Maintaining research access in police organizations. *Criminology, 16*(1), 87–98. <http://doi.org/10.1111/j.1745-9125.1978.tb01402.x>
- Lundman, R. J., & Fox, J. C. (1979). Lundman and Fox reply to Bell. *Criminology, 17*(1), 119–126. <http://doi.org/10.1111/j.1745-9125.1979.tb01280.x>
- Macdonald, S., Wells, S., & Wild, T. C. (1999). Occupational risk factors associated with alcohol and drug problems. *The American Journal of Drug and Alcohol Abuse, 25*(2), 351–369. <http://doi.org/10.1081/ADA-100101865>
- Maguire, E. R., & Mastrofski, S. D. (2000). Patterns of community policing in the United States. *Police Quarterly, 3*(1), 4–45. <http://doi.org/10.1177/1098611100003001001>
- Maguire, E. R., & Uchida, C. D. (2000). Measurement and explanation in the comparative study of American police organizations. In *Measurement and analysis of crime and justice* (pp. 491–557). (NCJ No. 182411). Washington, DC: U.S. Department of Justice, National Institute of Justice. Retrieved from http://www.ncjrs.gov/criminal_justice2000/vol4/04j.pdf

- Maher, T. M. (2003). Police sexual misconduct: Officers' perceptions of its extent and causality. *Criminal Justice Review*, 28(2), 355–381. <http://doi.org/10.1177/073401680302800209>
- Maher, T. M. (2008). Police chiefs' views on police sexual misconduct. *Police Practice and Research*, 9(3), 239–250. <http://doi.org/10.1080/15614260701797504>
- Manzoni, P., & Eisner, M. (2006). Violence between the police and the public: Influences of work-related stress, job satisfaction, burnout, and situational factors. *Criminal Justice and Behavior*, 33(5), 613–645. <http://doi.org/10.1177/0093854806288039>
- Mastrofski, S. D., Parks, R. B., Reiss, A. J., Worden, R. E., DeJong, C., Snipes, J. B., & Terrill, W. (1998). *Systematic observation of public police: Applying field research methods to policy issues*. (NCJ No. 172859). Washington, DC: U.S. Department of Justice, Office of Justice Programs, National Institute of Justice.
- McGhee, T. (2011, October 27). Denver police chief proposes double-check on DUI stops of public officials. *The Denver Post*.
- Menard, S. (2002). *Applied logistic regression analysis* (2nd ed.). Thousand Oaks, CA: Sage.
- Menard, S. (2010). *Logistic regression: From introductory to advanced concepts and applications*. Los Angeles, CA: Sage.
- Mieczkowski, T. (2002). Drug abuse, corruption, and officer drug testing: An overview. In K. M. Lersch (Ed.), *Policing and misconduct* (pp. 157–192). Upper Saddle River, NJ: Prentice Hall.
- Mieczkowski, T., & Lersch, K. M. (2002). Drug-testing police officers and police recruits: The outcome of urinalysis and hair analysis compared. *Policing: An International Journal of Police Strategies & Management*, 25(3), 581–601. <http://doi.org/10.1108/13639510210437041>

- Miranda v. Arizona, 384 U.S. 436 (1966).
- Mollen Commission. (1994). *Commission to Investigate Allegations of Police Corruption and the Anti-Corruption Procedures of the Police Department: Commission report: Anatomy of failure: A path for success*. New York, NY: The City of New York.
- Mullins, W. C., & McMains, M. J. (2000). Impact of traumatic stress on domestic violence in policing. In *Domestic violence by police officers: A compilation of papers submitted to the Domestic Violence by Police Officers Conference at the FBI Academy, Quantico, VA* (pp. 257–268). Washington, DC: U.S. Government Printing Office.
- National Center for Women & Policing. (2005). *Police family violence fact sheet*. Beverly Hills, CA: National Center for Women & Policing. Retrieved from <http://womenandpolicing.com/violenceFS.asp>
- National Institute on Alcohol Abuse and Alcoholism. (2008). *Alcohol and other drugs* (Alcohol Alert No. Alcohol Alert No. 76). Bethesda, MD: U.S. Department of Health and Human Services, National Institutes of Health, National Institute on Alcohol Abuse and Alcoholism. Retrieved from <http://pubs.niaaa.nih.gov/publications/AA76/AA76.htm>
- Neidig, P. H., Russell, H. E., & Seng, A. F. (1992). Interspousal aggression in law enforcement families: A preliminary investigation. *Police Studies: The International Review of Police Development*, 15(1), 30–38.
- Neidig, P. H., Seng, A. F., & Russell, H. E. (1992). Interspousal aggression in law enforcement personnel attending the FOP biennial conference. *National FOP Journal*, 25–28.
- Paddock, B., & Lesser, B. (2010, March 7). NYPD cops drive drunk, but no one puts on brakes: Even after messy crashes, police are still on job. *New York Daily News*. Retrieved from

- <http://www.nydailynews.com/news/crime/nypd-cops-drive-drunk-puts-brakes-messy-crashes-police-job-article-1.176249>
- Payne, B. K. (2013). *White-collar crime: The essentials*. Thousand Oaks, CA: Sage.
- Pennsylvania Crime Commission. (1974). *Report on police corruption and the quality of law enforcement in Philadelphia*. Saint Davids, PA: Commonwealth of Pennsylvania, Pennsylvania Crime Commission.
- Punch, M. (2000). Police corruption and its prevention. *European Journal on Criminal Policy and Research*, 8(3), 301–324.
- Rabe-Hemp, C. E., & Braithwaite, J. (2013). An exploration of recidivism and the officer shuffle in police sexual violence. *Police Quarterly*, 16(2), 127–147.
<http://doi.org/10.1177/1098611112464964>
- Ready, J., White, M. D., & Fisher, C. (2008). Shock value: A comparative analysis of news reports and official records on TASER deployments. *Policing: An International Journal of Police Strategies & Management*, 31(1), 148–170.
<http://doi.org/10.1108/13639510810852620>
- Reaves, B. A. (2012). *Hiring and retention of state and local law enforcement officers, 2008 - Statistical tables* (No. NCJ 238251). Washington, DC: U.S. Department of Justice, Office of Justice Programs, Bureau of Justice Statistics.
- Reiss, A. J. (1971). *The police and the public*. New Haven, CT: Yale University Press.
- Riffe, D., Lacy, S., & Fico, F. G. (2005). *Analyzing media messages: Using quantitative content analysis in research* (2nd ed.). Mahwah, NJ: Lawrence Erlbaum Associates.
- Rokach, L., & Maimon, O. (2005). Decision trees. In O. Maimon & L. Rokach (Eds.), *Data mining and knowledge discovery handbook* (pp. 165–192). New York, NY: Springer.

- Ross, J. I. (2000). *Making News of Police Violence: A Comparative Study of Toronto and New York City*. Westport, CT: Praeger.
- Ross, J. I. (2001). Police crime & democracy: Demystifying the concept, research, and presenting a taxonomy. In *Policing, security and democracy: Special aspects of democratic policing* (pp. 177–200). Huntsville, TX: Office of International Criminal Justice.
- Sapp, A. D. (1994). Sexual misconduct by police officers. In T. Barker & D. L. Carter (Eds.), *Police deviance* (pp. 187–199). Cincinnati, OH: Anderson.
- Sechrest, D. K., & Burns, P. (1992). Police Corruption: The Miami case. *Criminal Justice and Behavior*, 19(3), 294–313. <http://doi.org/10.1177/0093854892019003006>
- Sgambelluri, R. (2000). Police culture, police training, and police administration: Their impact on violence in police families. In *Domestic violence by police officers: A compilation of papers submitted to the Domestic Violence by Police Officers Conference at the FBI Academy, Quantico, VA* (pp. 309–322). Washington, DC: U.S. Government Printing Office.
- Sherman, L. W. (1974). *Police corruption: A sociological perspective*. Garden City, NY: Anchor Books.
- Sherman, L. W. (1978). *Scandal and reform: Controlling police corruption*. Berkeley, CA: University of California Press.
- Sherman, L. W. (1980). Perspectives on police and violence. *Annals of the American Academy of Political and Social Science*, 452, 1–12.
- Sherman, L. W., & Langworthy, R. H. (1979). Measuring homicide by police officers. *The Journal of Criminal Law & Criminology*, 70(4), 546–560.

- Shernock, S. K. (1995). Police solidarity. In W. G. Bailey (Ed.), *The encyclopedia of police science* (2nd ed., pp. 619–623). New York, NY: Garland.
- Shults, R. A., Beck, L. F., & Dellinger, A. M. (2011). Self-reported alcohol-impaired driving among adults in the United States, 2006 and 2008. *Injury Prevention, 16*(Supplement 1), A72–A73. <http://doi.org/10.1136/ip.2010.029215.264>
- Skogan, W., & Frydl, K. (2004). *Fairness and effectiveness in policing: The evidence*. Washington, DC: The National Academies Press.
- Skolnick, J. H. (1994). *Justice without trial: Law enforcement in democratic society*. New York: Macmillan.
- Smalley, S. (2006, July 30). 75 officers failed city drug tests: Cocaine use most prevalent, raising concern. *Boston Globe*, p. A1. Boston.
- Sonquist, J. A. (1970). *Multivariate model building: The validation of a search strategy*. Ann Arbor, MI: University of Michigan, Institute for Social Research, Survey Research Center.
- Stinson, P. M. (2009). *Police crime: A newsmaking criminology study of sworn law enforcement officers arrested, 2005-2007*. Indiana University of Pennsylvania, Indiana, PA. Retrieved from <http://hdl.handle.net/2069/207>
- Stinson, P. M., Brewer, S. L., Mathna, B. E., Liederbach, J., & Englebrecht, C. M. (2014). Police sexual misconduct: Arrested officers and their victims. *Victims & Offenders, 10*, 117–151. <http://doi.org/10.1080/15564886.2014.939798>
- Stinson, P. M., & Liederbach, J. (2013). Fox in the henhouse: A study of police officers arrested for crimes associated with domestic and/or family violence. *Criminal Justice Policy Review, 24*, 601–625. <http://doi.org/10.1177/0887403412453837>

- Stinson, P. M., Liederbach, J., Brewer, S. L., & Mathna, B. E. (2014). Police sexual misconduct: A national scale study of arrested officers. *Criminal Justice Policy Review*, *26*, 665–690. <http://doi.org/10.1177/0887403414526231>
- Stinson, P. M., Liederbach, J., Brewer, S. L., Schmalzried, H. D., Mathna, B. E., & Long, K. L. (2013). A study of drug-related police corruption arrests. *Policing: An International Journal of Police Strategies & Management*, *36*(3), 491–511. <http://doi.org/10.1108/PIJPSM-06-2012-0051>
- Stinson, P. M., Liederbach, J., Brewer, S. L., & Todak, N. E. (2014). Drink, drive, go to jail? A study of police officers arrested for drunk driving. *Journal of Crime and Justice*, *37*(3), 356–376. <http://doi.org/10.1080/0735648X.2013.805158>
- Stinson, P. M., Liederbach, J., & Freiburger, T. L. (2010). Exit strategy: An exploration of late-stage police crime. *Police Quarterly*, *13*(4), 413–435. <http://doi.org/10.1177/1098611110384086>
- Stinson, P. M., Liederbach, J., & Freiburger, T. L. (2012). Off-duty and under arrest: A study of crimes perpetrated by off-duty police. *Criminal Justice Policy Review*, *23*, 139–163. <http://doi.org/10.1177/0887403410390510>
- Stinson, P. M., Reyns, B. W., & Liederbach, J. (2012). Police crime and less-than-lethal coercive force: A description of the criminal misuse of TASERS. *International Journal of Police Science & Management*, *14*(1), 1–19. <http://doi.org/10.1350/ijps.2012.14.1.237>
- Stinson, P. M., Todak, N. E., & Dodge, M. (2013). An exploration of crime by policewomen. *Police Practice and Research*. <http://doi.org/10.1080/15614263.2013.846222>

Stinson, P. M., Todak, N. E., & Dodge, M. (2015). An exploration of crime by policewomen.

Police Practice and Research, 16(1), 79–93.

<http://doi.org/10.1080/15614263.2013.846222>

Stinson, P. M., & Watkins, A. M. (2014). The nature of crime by school resource officers:

Implications for SRO programs. *Sage Open*, 4(1), 1–10.

<http://doi.org/10.1177/2158244014521821>

Stoddard, E. R. (1968). The informal code of police deviancy: A group approach to blue-coat

crime. *The Journal of Criminal Law, Criminology and Police Science*, 59(2), 201–213.

Swatt, M. L., Gibson, C. L., & Piquero, N. L. (2007). Exploring the utility of general strain

theory in explaining problematic alcohol consumption by police officers. *Journal of*

Criminal Justice, 35, 596–611. <http://doi.org/10.1016/j.jcrimjus.2007.09.005>

Terrill, W. (2003). Police use of force and suspect resistance: The micro process of the police-

suspect encounter. *Police Quarterly*, 6(1), 51–83.

<http://doi.org/10.1177/1098611102250584>

Terrill, W., & Mastrofski, S. D. (2002). Situational and officer-based determinants of police

coercion. *Justice Quarterly*, 19(2), 215–248. <http://doi.org/10.1080/07418820200095221>

Terrill, W., Paoline, E. A., & Manning, P. K. (2003). Police culture and coercion. *Criminology*,

41(4), 1003–1034. <http://doi.org/10.1111/j.1745-9125.2003.tb01012.x>

Terrill, W., & Reisig, M. D. (2003). Neighborhood context and police use of force. *Journal of*

Research in Crime and Delinquency, 40(3), 291–321.

<http://doi.org/10.1177/0022427803253800>

- U.S. Department of Agriculture. (2003). *Measuring rurality: Rural-urban continuum codes*. [Computer file]. Washington, DC: U.S. Department of Agriculture, Economic Research Service. Retrieved from <http://www.ers.usda.gov/briefing/rurality/ruralurbcon/>
- U.S. Department of Justice. (2000). *National Incident-Based Reporting System: Data collection guidelines*. Washington, DC: U.S. Department of Justice, Federal Bureau of Investigation, Criminal Justice Information Services Division. Retrieved from http://www.fbi.gov/about-us/cjis/ucr/nibrs/nibrs_dcguide.pdf/view
- U.S. Department of Justice. (2004). *Uniform crime reporting handbook*. Washington, DC: U.S. Department of Justice, Federal Bureau of Investigation. Retrieved from http://www.fbi.gov/about-us/cjis/ucr/additional-ucr-publications/ucr_handbook.pdf
- U.S. Department of Justice. (2008). *Census of state and local enforcement agencies (CSLLEA)*. 2008 [ICPSR27681-v1 data set]. Ann Arbor, MI: Inter-university Consortium for Political and Social Research [distributor], 2011-08-03. doi:10.3886/ICPSR27681.v1.
- U.S. General Accounting Office. (1998). *Report to the Honorable Charles B. Rangel, House of Representatives: Law Enforcement: Information on drug-related police corruption*. Washington, DC: U.S. General Accounting Office.
- Violanti, J. M., Marshall, J. R., & Howe, B. (1985). Stress, coping, and alcohol use: The police connection. *Journal of Police Science and Administration*, 13(2), 106–110.
- Violanti, J. M., Slaven, J. E., Charles, L. E., Burchfiel, C. M., Andrew, M. E., & Homish, G. G. (2011). Police and alcohol use: A descriptive analysis and associations with stress outcomes. *American Journal of Criminal Justice*, 36(4), 344–356.
<http://doi.org/10.1007/s12103-011-9121-7>

- Walker, S., & Irlbeck, D. (2002). *Driving while female: A national problem in police misconduct*. Omaha, NE: University of Nebraska at Omaha, Department of Criminal Justice, Police Professionalism Initiative. Retrieved from <http://www.policeaccountability.org/drivingfemale.htm>
- Walker, S., & Irlbeck, D. (2003). *Police sexual abuse of teenage girls: A 2003 update on driving while female*. Omaha, NE: University of Nebraska at Omaha, Department of Criminal Justice, Police Professionalism Initiative. Retrieved from internal-pdf://PSA,%2520teenage%2520girls-1063221248/PSA,%2520teenage%2520girls.pdf
- Wetendorf, D. E. (2000). The impact of police-perpetuated domestic violence. In *Domestic violence by police officers: A compilation of papers submitted to the Domestic Violence by Police Officers Conference at the FBI Academy, Quantico, VA* (pp. 375–382). Washington, DC: U.S. Government Printing Office.
- White, M. D., & Ready, J. (2009). Examining fatal and nonfatal incidents involving the TASER: Identifying predictors of suspect death reported in the media. *Criminology & Public Policy*, 8(4), 865–891. <http://doi.org/10.1111/j.1745-9133.2009.00600.x>
- Wilkinson, L. (1992). Tree structured data analysis: AID, CHAID, and CART. Presented at the Sawtooth/SYSTAT Joint Software Conference, Sun Valley, ID.
- Wilson, J. Q. (1963). The police and their problems: A theory. *Public Policy*, 12, 189–216.

DISSEMINATION OF RESEARCH FINDINGS

Publications

Journal Articles

Stinson, P. M. (2015). Police crime: The criminal behavior of sworn law enforcement officers. *Sociology Compass*, 9(1), 1-13. doi:10.1111/soc4.12234

Stinson, P. M., Brewer, S. L., Mathna, B. E., Liederbach, J., & Englebrecht, C. M. (2014). Police sexual misconduct: Arrested officers and their victims. *Victims & Offenders*, 10(2), 117-151. doi:10.1080/15564886.2014.939798

Stinson, P. M., Liederbach, J., Brewer, S. L., Jr., & Mathna, B. E. (2014). Police sexual misconduct: A national scale study of arrested officers. *Criminal Justice Policy Review*, 26(7), 665-690. doi:10.1177/0887403414526231

Stinson, P. M., & Watkins, A. M. (2014). The nature of crime by school resource officers: Implications for SRO programs. *Sage Open*, 4(1), 1-10. doi:10.1177/2158244014521821

Stinson, P. M., Todak, N. E., & Dodge, M. (2013). An exploration of crime by policewomen. *Police Practice and Research: An international journal*, 16(1), 79-93. doi:10.1080/15614263.2013.846222

Stinson, P. M., Liederbach, J., Brewer, S. L., Jr., & Todak, N. E. (2013). Drink, drive, go to jail? A study of police officers arrested for drunk driving. *Journal of Crime and Justice*, 37(3), 356-376. doi:10.1080/0735648X.2013.805158

Stinson, P. M., Liederbach, J., Brewer, S. L., Jr., Schmalzried, H. N., Mathna, B. E., & Long, K. L. (2013). A study of drug-related police corruption arrests. *Policing: An International Journal of Police Strategies & Management*, 36(3), 491-511. doi:10.1108/PIJPSM-06-2012-0051

Stinson, P. M. & Liederbach, J. (2013). Fox in the henhouse: A study of police officers arrested for crimes associated with domestic and/or family violence. *Criminal Justice Policy Review*, 24, 601-625. doi:10.1177/0887403412453837

Non-refereed Articles

Stinson, P. M. & Liederbach, J. (2013). Research-in-brief: Sex-related police misconduct. *Police Chief*, 80(8), 14-15.

Stinson, P. M. & Liederbach, J. (2012). Research-in-brief: Misconduct by experienced police officers. *Police Chief*, 79(11), 12.

Stinson, P. M. & Liederbach, J. (2012). Research-in-brief: Officer-involved domestic violence. *Police Chief*, 79(9), 14.

Technical Reports

Stinson, P. M., Calogeras, Z. J., DiChiro, N. L., & Hunter, R. K. (2015). *California police sexual misconduct arrest cases, 2005-2011*. Prepared for the California Research Bureau, California State Library, Sacramento, CA.

Podcasts

Stinson, P. M. (2015, December). Police shootings: Does video evidence matter? *Police Integrity Lost* (Audio podcast), Episode 27. Available at iTunes.

Stinson, P. M. (2015, November). What we know about police crime. *Police Integrity Lost* (Audio podcast), Episode 26. Available at iTunes.

Stinson, P. M. (2015, October). Violence by school resource officers. *Police Integrity Lost* (Audio podcast), Episode 25. Available at iTunes.

Stinson, P. M. (2015, July). Police crime in America: Phil Stinson at Porcfest 2015. *Police Integrity Lost* [Audio podcast], Episode 24. Available at iTunes.

Stinson, P. M. (2015, May). Police shootings in Albuquerque. *Police Integrity Lost* [Audio podcast], Episode 23. Available at iTunes.

Stinson, P. M. (2015, January). Research on crimes committed by sworn police officers. *Police Integrity Lost* [Audio podcast], Episode 22. Available at iTunes.

Stinson, P. M. (2014, December). Police crime: Grand juries, juries and conviction of officers. *Police Integrity Lost* [Audio podcast], Episode 21. Available at iTunes.

Stinson, P. M. (2014, November). Constitutional torts, section 1983, and police misconduct: Presentation at 2014 ASC Conference. *Police Integrity Lost* [Audio podcast], Episode 20. Available at iTunes.

Stinson, P. M. (2014, August). Gun-involved police crime arrests. *Police Integrity Lost* [Audio podcast], Episode 19. Available at iTunes.

Stinson, P. M., & Brewer, S. L. (2014, February). Victims of police sexual misconduct: Presentation at 2014 ACJS conference. *Police Integrity Lost* [Audio podcast], Episode 18. Available at iTunes.

Stinson, P. M. (2014, January). Research performance progress report for July-December 2013. *Police Integrity Lost* [Audio podcast], Episode 17. Available at iTunes.

Stinson, P. M., & Watkins, A. M. (2013, December). Crime by school resource officers. *Police Integrity Lost* [Audio podcast], Episode 16. Available at iTunes.

- Stinson, P. M., & Brewer, S. L. (2013, November). Police integrity lost: Presentation at 2013 ASC conference. *Police Integrity Lost* [Audio podcast], Episode 15. Available at iTunes.
- Stinson, P. M., & Liederbach, J. (2013, October). Police sexual misconduct: Policy implications. *Police Integrity Lost* [Audio podcast], Episode 14. Available at iTunes.
- Stinson, P. M. (2013, August). Police Crime Research Findings. *Police Integrity Lost* [Audio podcast], Episode 13. Available at iTunes.
- Stinson, P. M. (2013, July). Research performance progress report for January-June 2013. *Police Integrity Lost* [Audio podcast], Episode 12. Available at iTunes.
- Stinson, P. M., & Liederbach, J. (2013, June). Police sexual misconduct arrests. *Police Integrity Lost* [Audio podcast], Episode 11. Available at iTunes.
- Stinson, P. M. (2013, May). Using a content management system: Police crime research methods part 3. *Police Integrity Lost* [Audio podcast], Episode 10. Available at iTunes.
- Stinson, P. M., Brewer, S. L., & Liederbach, J. (2013, April). Drunk driving cops. *Police Integrity Lost* [Audio podcast], Episode 9. Available at iTunes.
- Stinson, P. M., & Brewer, S. L. (2013, March). Using Google News for data collection: Police crime research methods part 2. *Police Integrity Lost* [Audio podcast], Episode 8. Available at iTunes.
- Stinson, P. M., & Brewer, S. L. (2013, February). Decision Tree Analysis: Police crime research methods part 1. *Police Integrity Lost* [Audio podcast], Episode 7. Available at iTunes.
- Stinson, P. M., & Liederbach, J. (2013, January). Late-stage police crime. *Police Integrity Lost* [Audio podcast], Episode 6. Available at iTunes.
- Stinson, P. M., & Todak, N. E. (2012, December). Crime by policewomen. *Police Integrity Lost* [Audio podcast], Episode 5. Available at iTunes.
- Stinson, P. M., & Liederbach, J. (2012, November). Police Criminal Misuse of TASERS. *Police Integrity Lost* [Audio podcast], Episode 4. Available at iTunes.
- Stinson, P. M., & Liederbach, J. (2012, October). Off-Duty police crime. *Police Integrity Lost* [Audio podcast], Episode 3. Available at iTunes.
- Stinson, P. M., & Liederbach, J. (2012, September). Officer-involved domestic violence. *Police Integrity Lost* [Audio podcast], Episode 2. Available at iTunes.
- Stinson, P. M., Liederbach, J., & Brewer, S. L. (2012, August). Police drug corruption. *Police Integrity Lost* [Audio podcast], Episode 1. Available at iTunes.

Stinson, P. M. & Liederbach, J. (2012). Fox in the henhouse: A study of police officers arrested for crimes associated with domestic and/or family violence. *Criminal Justice Policy Review* [Audio podcast]. Available at: <http://cjp.sagepub.com/content/early/2012/07/18/0887403412453837/suppl/DC1>

Research Briefs

Stinson, P. M., Liederbach, J., Brewer, S. L., & Todak, N. E. (2013). *Officers arrested for drunk driving: Police Integrity Lost Research Brief One-Sheet, No. 6*. Bowling Green, OH: Bowling Green State University. Available at: <http://www.bgsu.edu/departments/dhs/crju/file129810.pdf>

Stinson, P. M., Reyns, B. W., & Liederbach, J. (2013). *Police criminal misuse of conductive energy devices: Police Integrity Lost Research Brief One-Sheet, No. 5*. Bowling Green, OH: Bowling Green State University. Available at: <http://www.bgsu.edu/departments/dhs/crju/file129809.pdf>

Stinson, P. M., & Liederbach, J. (2012). *Officer-involved domestic violence: Police Integrity Lost Research Brief One-Sheet, No. 4*. Bowling Green, OH: Bowling Green State University. Available at: <http://www.bgsu.edu/downloads/chhs/file118292.pdf>

Stinson, P. M., Liederbach, J., Brewer, S., Schmalzried, H., Mathna, B. E., & Long, K. (2012). *Police drug corruption: What are the drugs of choice? Police Integrity Lost Research Brief One-Sheet, No. 3*. Bowling Green, OH: Bowling Green State University. Available at: <http://www.bgsu.edu/downloads/chhs/file118291.pdf>

Stinson, P. M., Liederbach, J., & Freiburger, T. L. (2012). *Off-duty crime by police officers: Police Integrity Lost Brief One-Sheet, No. 2*. Bowling Green, OH: Bowling Green State University. Available at: <http://www.bgsu.edu/downloads/chhs/file118290.pdf>

Stinson, P. M., Liederbach, J., & Freiburger, T. L. (2012). *Late-stage police crime: Is it an exit strategy? Police Integrity Lost Research Brief One-Sheet, No. 1*. Bowling Green, OH: Bowling Green State University. Available at: <http://www.bgsu.edu/downloads/chhs/file118289.pdf>

Presentations

Stinson, P. M. (2015, November 4). Police crime: *What we've learned and what we don't know*. Center for Family and Demographic Research, Bowling Green State University, Bowling Green, OH.

Stinson, P. M. (2015, October 29). *Police crime in the United States: From shootings to shoplifting*. Owens Community College, Findlay, OH.

Stinson, P. M. (2015, October 21). *Use of data in research on police crime*. Introduction to Data Science Seminar, Department of Mathematics & Statistics, Bowling Green State University, Bowling Green, OH.

Ory, R. & Stinson, P. M. (2015, September 24). *Intercoder reliability assessment of supplemental document coding in a quantitative content analysis study of police crime in the United States*. Annual meeting of the Midwestern Criminal Justice Association, Chicago, IL.

Stinson, P. M. (2015, June 27). *Police integrity lost: Police crime in the United States*. 12th Annual Porcupine Freedom Festival ("PorcFest"), Free State Project, Lancaster, NH.

Buerger, M. E., & Stinson, P. M. (2015, March 16). *Police misconduct & implicit bias research: Bridging the gap?* Ohio Attorney General, Bureau of Criminal Investigation, Bowling Green, OH.

Stinson, P. M., Brewer, S. L., & Bridges, J. (2015, March 5). *Violence-related police crime arrests in the United States*. Annual meeting of the Academy of Criminal Justice Sciences, Orlando, FL.

Stinson, P. M., Brewer, S. L., Lanese, T., & Wilson, M. A. (2014, November 21). *Federal civil rights litigation pursuant to 42 U.S.C. §1983 as a correlate of police misconduct*. Annual meeting of the American Society of Criminology, San Francisco, CA.

Stinson, P. M., Carmack, E. J., Frankhouser, J. M., & Wilson, M. A. (2014, November 20). *Police crime arrests in the United States, 2011*. Annual meeting of the American Society of Criminology, San Francisco, CA.

Stinson, P.M., Brewer, S.L., Englebrecht, C.M., Liederbach, J., & Mathna, B.E. (2014, February 21). *Police sexual misconduct: Arrested officers and their victims*. Annual meeting of the Academy of Criminal Justice Sciences, Philadelphia, PA.

Stinson, P. M. (2013, December 12). *Police integrity lost: A study of law enforcement officers arrested: Lessons learned*. Bowling Green State University, College of Health and Human Services, Colloquium.

Stinson, P. M., Liederbach, J., Lab, S. P., & Brewer, S. L. (2013, November 21). *Police integrity lost: A study of law enforcement officers arrested*. Annual meeting of the American Society of Criminology, Atlanta, GA.

Stinson, P. M., Brewer, S. L., Englebrecht, C. M., Mathna, B. E., & Liederbach, J. (2013, November 21). *Police sexual misconduct arrests: An exploratory CART analysis*. Annual meeting of the American Society of Criminology, Atlanta, GA.

Stinson, P. M. (2013, July 30). *Police integrity lost: Preliminary findings of a national study of law enforcement officers arrested*. Conference on Police Misconduct sponsored by the APA Division on Psychologists in Public Service, Section on Police and Public Safety at the annual meeting of the American Psychological Association, Honolulu, HI.

Stinson, P. M., Liederbach, J., Brewer, S. L., Englebrecht, C. E., & Mathna, B. E. (2013, March 21). *Police sexual misconduct arrests: An exploratory study*. Annual meeting of the Academy of Criminal Justice Sciences, Dallas, TX.

Stinson, P. M., Liederbach, J., Todak, E. N., & Brewer, S. L. (2012, November 15). *Drunk driving cops: A study of police officers arrested for DUI, 2005-2010*. Annual meeting of the American Society of Criminology, Chicago, IL.

Stinson, P. M., Liederbach, J., Brewer, S. L., Jr., Schmalzried, H. N., Mathna, B. E., & Long, K. L. (2012, November 15). *CHAID analysis of drug-related police corruption arrests*. Annual meeting of the American Society of Criminology, Chicago, IL.

Stinson, P. M. (2012, June 20). *Police integrity lost: Preliminary findings from a study of law enforcement officers arrested, 2005-2011*. 2012 National Institute of Justice (NIJ) Conference, Arlington, VA.

Stinson, P. M., Liederbach, J., Schmalzried, H., Long, K. L., & Mathna, B. E. (2012, March 16). *Officers' drugs of abuse: A study of drug-related police crime*. Annual meeting of the Academy of Criminal Justice Sciences, New York, NY.

Table 1. Police Crime Arrest Cases, 2005-2011: Arrested Officers and Employing Agencies (*N* = 6,724)

	<i>n</i>	(%)		<i>n</i>	(%)		<i>n</i>	(%)
Sex			Officer Duty Status			Agency Type		
Male	6,357	(94.5)	On-Duty	2,793	(41.5)	Primary State Police	269	(4.0)
Female	367	(5.5)	Off-Duty	3,931	(58.5)	Sheriff's Office	1,109	(16.5)
Age			Rank			County Police Dept.	226	(3.4)
19-23	136	(2.0)	Officer	5,095	(75.8)	Municipal Police Dept.	4,915	(73.1)
24-27	603	(9.0)	Detective	369	(5.5)	Special Police Dept.	174	(2.6)
28-31	886	(13.2)	Corporal	123	(1.8)	Constable	15	(0.2)
32-35	967	(14.4)	Sergeant	581	(8.7)	Tribal Police Dept.	14	(0.2)
36-39	1,081	(16.1)	Lieutenant	177	(2.6)	Regional Police Dept.	2	(0.0)
40-43	885	(13.2)	Captain	63	(0.9)	Full-Time Sworn Officers		
44-47	614	(9.1)	Major	12	(0.2)	0	31	(0.4)
48-51	343	(5.1)	Colonel	4	(0.1)	1	59	(0.9)
52-55	178	(2.6)	Deputy Chief	49	(0.7)	2-4	274	(4.1)
56 or older	170	(2.5)	Chief	251	(3.7)	5-9	376	(5.6)
Missing	861	(12.8)	Function			10-24	684	(10.2)
Years of Service			Patrol & Street Level	5,464	(81.3)	25-49	679	(10.1)
0-2	756	(11.2)	Line/Field Supervisor	881	(13.1)	50-99	704	(10.5)
3-5	954	(14.2)	Management	379	(5.6)	100-249	859	(12.8)
6-8	666	(9.9)	Region of United States			250-499	653	(9.7)
9-11	622	(9.3)	Northeastern States	1,430	(21.3)	500-999	548	(8.1)
12-14	507	(7.5)	Midwestern States	1,380	(20.5)	1,000 or more	1,857	(27.6)
15-17	409	(6.1)	Southern States	2,906	(43.2)	Part-Time Sworn Officers		
18-20	387	(5.8)	Western States	1,008	(15.0)	0	5,008	(74.5)
21-23	194	(2.9)	Level of Rurality			1	218	(3.3)
24-26	129	(1.9)	Metropolitan County	5,711	(84.9)	2-4	528	(7.9)
27 or more years	156	(2.3)	Non-Metro County	1,013	(15.1)	5-9	419	(6.2)
Missing	1,944	(28.9)	Arresting Agency			10-24	372	(5.5)
Employing Agency	2,277	(33.9)	Employing Agency			25-49	120	(1.8)
Another Agency	4,447	(66.1)	Another Agency			50-99	49	(0.7)
						100-249	8	(0.1)
						250-499	2	(0.0)

Table 2. Most Serious Offense Charged in Police Crime Arrest Cases, 2005-2011 (*N* = 6,724)

	<i>n</i>	(%)		<i>n</i>	(%)
Simple Assault	877	(13.0)	Online Solicitation of a Child	44	(0.7)
Driving Under the Influence	841	(12.5)	Prostitution	42	(0.6)
Aggravated Assault	572	(8.5)	Stolen Property Offenses	39	(0.6)
Forcible Fondling	352	(5.2)	Indecent Exposure	38	(0.6)
Forcible Rape	322	(4.8)	Kidnapping / Abduction	37	(0.6)
Drug / Narcotic Violation	308	(4.6)	Shoplifting	31	(0.5)
All Other Larceny	274	(4.1)	Hit & Run	27	(0.4)
All Other Offenses	265	(3.9)	Restraining Order Violation	25	(0.4)
Intimidation	255	(3.8)	Impersonation	22	(0.3)
False Pretenses / Swindle	218	(3.2)	Drunkenness	22	(0.3)
Weapons Law Violation	143	(2.1)	Theft from Motor Vehicle	21	(0.3)
Official Misconduct / Oppression / Violation of Oath	139	(2.1)	Family Offenses, Nonviolent	20	(0.3)
False Report / False Statement	129	(1.9)	Liquor Law Violation	19	(0.3)
Murder / Nonnegligent Manslaughter	125	(1.9)	Evidence: Destroying / Tampering	17	(0.3)
Burglary / Breaking & Entering	112	(1.7)	Assisting or Promoting Prostitution	12	(0.2)
Robbery	109	(1.6)	Wire Fraud	10	(0.1)
Theft from Building	103	(1.5)	Sexual Assault with an Object	10	(0.1)
Statutory Rape	100	(1.5)	Gambling: Operating / Promoting	9	(0.1)
Other Sex Crime	98	(1.5)	Credit Card Fraud / ATM Fraud	7	(0.1)
Extortion / Blackmail	95	(1.4)	Motor Vehicle Theft	7	(0.1)
Forcible Sodomy	94	(1.4)	Trespass of Real Property	7	(0.1)
Obstructing Justice	93	(1.4)	Wiretapping, Illegal	6	(0.1)
Pornography / Obscene Material	86	(1.3)	Incest	4	(0.1)
Civil Rights Violation	84	(1.2)	Gambling: Betting / Wagering	3	(0.0)
Bribery	80	(1.2)	Theft of Motor Vehicle Parts or Accessories	3	(0.0)
Embezzlement	79	(1.2)	Peeping Tom	2	(0.0)
Disorderly Conduct	67	(1.0)	Welfare Fraud	1	(0.0)
Negligent Manslaughter	62	(0.9)	Pocket-picking	1	(0.0)
Arson	57	(0.8)	Theft from Coin-operated Machine	1	(0.0)
Counterfeiting/ Forgery	51	(0.8)	Bad Checks	1	(0.0)
Destruction of Property / Vandalism	46	(0.7)			

Note. Table equals 99.9%. The last four categories collectively account for the missing 0.1%.

Table 3. Victim Characteristics in Police Crime Arrest Cases, 2005-2011 (*N* = 6,724)

	<i>n</i>	(%)	(Valid %)		<i>n</i>	(%)	(Valid %)
Victim's Sex				Victim's Relationship			
Female	2,246	(33.4)	(61.2)	Current Spouse	346	(5.1)	(8.8)
Male	1,422	(21.2)	(38.8)	Former Spouse	68	(1.0)	(1.7)
Missing	3,056	(45.4)		Current Girlfriend or Boyfriend	202	(3.0)	(5.1)
Victim's Age				Former Girlfriend or Boyfriend	136	(2.0)	(3.5)
Birth-11	185	(2.7)	(10.0)	Child or Stepchild	177	(2.7)	(4.5)
12-13	141	(2.1)	(7.6)	Some Other Relative	95	(1.4)	(2.4)
14-15	248	(3.7)	(13.4)	Unrelated Child	673	(10.0)	(17.1)
16-17	213	(3.2)	(11.5)	Stranger or Acquaintance	2,237	(33.3)	(56.9)
18-19	121	(1.8)	(6.6)	Missing	2,790	(41.5)	
20-24	223	(3.3)	(12.1)	Victim's Law Enforcement Status			
25-32	296	(4.4)	(16.0)	Victim is Not a Police Officer	3,738	(55.6)	(94.2)
33-41	214	(3.2)	(11.6)	Victim is a Police Officer	229	(3.4)	(5.8)
42 or older	207	(3.1)	(11.2)	Missing	2,757	(41.0)	
Missing	4,876	(72.5)		Victim Adult or Child			
				Adult	3,051	(45.3)	(76.5)
				Child	939	(14.0)	(23.5)
				Missing	2,734	(40.7)	

Table 4. Chi-Square Predicting Conviction

Variable Label	Variable	<i>N</i>	χ^2	<i>df</i>	<i>p</i>	<i>V</i>
Gender	V5	3934	5.482	1	.019	.037
Rank	V7	3934	26.257	9	.002	.082
FTSWORN cat	V10	3934	36.001	10	.000	.096
State	V11	3934	142.585	50	.000	.190
Urban to Rural	V13	3934	36.934	8	.000	.097
Arresting Agency	V14	3934	8.497	1	.004	.046
Aggravated Assault	V16	3934	34.925	1	.000	.094
Simple Assault	V17	3934	127.681	1	.000	.180
Intimidation	V18	3934	11.156	1	.001	.053
Bribery	V19	3934	10.856	1	.001	.053
Burglary	V20	3934	13.870	1	.000	.059
Drug/Narcotic	V23	3934	56.106	1	.000	.119
Embezzlement	V25	3934	19.423	1	.000	.070
Extortion/Blackmail	V26	3934	26.793	1	.000	.083
False Pretenses/Swindle	V27	3934	8.964	1	.003	.048
Impersonation	V29	3934	5.048	1	.025	.036
Wire Fraud	V31	3934	5.931	1	.015	.039
Theft from Building	V43	3934	5.831	1	.016	.038
Theft / all other larceny	V47	3934	7.746	1	.005	.044
Pornography	V49	3934	21.882	1	.000	.075
Robbery	V52	3934	12.581	1	.000	.057
Forcible Rape	V53	3934	3.967	1	.046	.032
Forcible Sodomy	V54	3934	13.219	1	.000	.058
Forcible Fondling	V56	3934	11.077	1	.001	.053
Statutory Rape	V58	3934	10.100	1	.001	.051
Online Solicitation of a Child	V60	3934	6.657	1	.010	.041
Stolen Property Offenses	V62	3934	10.333	1	.001	.051
Weapons Law violation	V63	3934	6.421	1	.011	.040
Criminal Civil Rights Violation	V65	3934	6.770	1	.009	.041
Driving Under the Influence	V67	3934	13.548	1	.000	.059
Evidence: Destroying/Tampering	V69	3934	5.688	1	.017	.038
Family Offenses, Nonviolent	V71	3934	25.104	1	.000	.080
Liquor Law violation	V73	3934	4.962	1	.026	.036
Gender of Victim	V81	2225	6.922	1	.009	.056

Age of Victim	V83	1186	110.509	1	.005	.305
Is the Victim a Child?	V84	2397	34.675	1	.000	.120
Victim's Relationship to Offender	V85	2374	114.234	7	.000	.219
Internal vs. Organizational	V91	3934	20.205	2	.000	.072
Drug-related	V93	3934	64.029	1	.000	.128
Alcohol-related	V94	3934	3.794	1	.051	.031
Sex-related	V95	3934	41.888	1	.000	.103
Violence-related	V96	3934	72.332	1	.000	.136
Profit-motivated	V97	3934	82.610	1	.000	.145
Police Sexual Violence	V98	3934	14.144	1	.000	.060
Driving While Female Encounter	V99	3934	4.130	1	.042	.032
Officer was Reassigned	V102	3934	13.688	1	.000	.059
Officer was Suspended	V104	3934	28.227	1	.000	.085
Discussion of Agency Scandal/Coverup	V107	3934	4.408	1	.036	.033
Citizen Complaint as Method of Detection	V108	3934	18.048	1	.000	.068
DUI-related Traffic Accident	V110	3934	20.021	1	.000	.071
Injuries in DUI-related Traffic Accident	V111	3934	13.864	1	.000	.059
DUI in a Personally-owned Vehicle	V115	3934	15.255	1	.000	.062
Off-Duty Intervened in Existing Dispute	V125	3934	5.234	1	.022	.036
Family Violence	V126	3934	84.832	1	.000	.147
Heroin	V129	3934	8.206	1	.004	.046
Oxycodone	V133	3934	8.108	1	.004	.045
Benzodiazepines	V137	3934	3.833	1	.050	.031
Cocaine	V139	3934	40.311	1	.000	.101
Crack	V140	3934	7.553	1	.006	.044
Amphetamine/Methamphetamine	V141	3934	5.265	1	.022	.037
Marijuana	V148	3934	12.971	1	.000	.057
OIDV: Weapon: Gun dept-issued	V156	3934	4.004	1	.045	.032
OIDV: Weapon: Hands / Fist	V164	3934	90.491	1	.000	.152
OIDV: Weapon: Miscellaneous Objects	V166	3934	8.456	1	.004	.046
OIDV: Verbal Threats / Violent Ultimatums	V167	3934	12.370	1	.000	.056
OIDV: Gun was Confiscated	V168	3934	7.587	1	.000	.044
OIDV: Confiscated Gun was Returned	V169	3934	15.729	1	.000	.063
OIDV: Order of Protection Filed	V171	3934	12.261	1	.000	.056
OIDV: Victim Injured, Nonfatal	V173	3934	97.134	1	.000	.157
OIDV: Victim Injured, Fatal	V174	3934	4.710	1	.030	.035

Most Serious Offense Charged	V183	3934	394.757	61	.000	.317
Drugs: Personal Use / Using	V196	3934	6.964	1	.008	.042
Drugs: Selling / Dealing / Trafficking	V197	3934	53.674	1	.000	.117
Drugs: Sexually-motivated Drug Crime	V199	3934	6.282	1	.012	.040
Drugs: Facilitating Drug Trade	V201	3934	25.713	1	.000	.081
Drugs: Shakedowns from Street Dealers	V202	3934	12.135	1	.000	.056
Drugs: Shakedowns from Warrantless Searches	V204	3934	9.089	1	.003	.048
Drugs: Shakedowns from Legitimate Raids/Searches	V205	3934	5.931	1	.015	.039
Drugs: Shakedowns from Car Stops & Drug Couriers	V206	3934	15.316	1	.000	.062
Drugs: Shakedowns from Off-Duty Robberies	V207	3934	10.471	1	.001	.052
Drugs: Theft from Evidence Room	V208	3934	8.363	1	.004	.046
Drugs: Shakedown (Aggregate of V202 thru V207)	V210	3934	27.249	1	.000	.083
Narcotics	Narcotics	3934	14.283	1	.000	.060
Stimulants	Stimulants	3934	48.853	1	.000	.111
Hallucinogens	Hallucinogens	3934	5.157	1	.023	.036
Cannabis	Cannabis	3934	12.971	1	.000	.057
Age Categorical	AgeCategorical	3934	48.283	10	.000	.111
Years of Service Categorical	YearsServCat	3934	33.658	10	.000	.092
Geographic Region	GeogRegion	3934	16.627	3	.001	.065
Geographic Division	GeogDivision	3934	35.632	8	.000	.095
Victim Age Categorical	VictimAgeCat	3934	40.074	9	.000	.101

Table 5. Logistic Regression Model Predicting Conviction ($N = 2,195$)

	<i>B</i>	<i>SE</i>	Wald	<i>p</i>	Exp(B)	95% CI for Exp(B)	
						<i>LL</i>	<i>UL</i>
Rank	-0.097	0.025	15.141	<.001	0.908	0.865	0.953
Full-Time Sworn Personnel Categorical	-0.061	0.020	8.987	.003	0.941	0.904	0.979
Child Victim	0.379	0.135	7.830	.005	1.461	1.120	1.905
Victim Relationship to Offender	0.074	0.028	7.111	.008	1.076	1.020	1.136
Alcohol-related Crime	0.463	0.162	8.178	.004	1.589	1.157	2.183
Sex-related Crime	0.792	0.128	38.390	<.001	2.208	1.719	2.837
Profit-motivated Crime	0.572	0.198	8.334	.004	1.772	1.202	2.612
Suspended	-0.342	0.112	9.247	.002	0.710	0.570	0.886
DUI in a Personally-owned Vehicle	1.058	0.374	7.990	.005	2.880	1.383	5.998
OIDV: Weapon: Verbal Threat / Violent Ultimatum	0.566	0.255	4.925	.026	1.760	1.068	2.901
OIDV: Victim Injured, Nonfatal	-0.491	0.184	7.152	.007	0.612	0.427	0.877
OIDV: Victim Injured, Fatal	2.068	0.629	10.794	.001	7.907	2.303	27.147
Most Serious Offense Charged	0.006	0.003	5.727	.017	1.006	1.001	1.011
Drug Shakedown	2.641	1.027	6.610	.010	14.024	1.873	104.991
Age Categorical	0.033	0.013	6.831	.009	1.034	1.008	1.060
Years of Service Categorical	0.034	0.009	14.985	<.001	1.035	1.017	1.053
- 2 Log Likelihood	2457.484						
Model Chi-Square	299.873			<.001			
Cox & Snell R^2	.128						
Nagelkerke R^2	.179						
ROC R^2	.436						
AUC	.718						
						95% CI for AUC	
						<i>LL</i>	<i>UL</i>
						.697	.740

Table 6. Chi-Square Predicting Job Loss

Variable Label	Variable	<i>N</i>	χ^2	<i>df</i>	<i>p</i>	<i>V</i>
Age	V3	5863	77.984	56	.028	.115
Years of Service	V4	4780	69.760	43	.006	.121
Gender	V5	6724	11.162	1	.001	.041
Duty Status	V6	6724	207.332	1	.000	.176
Rank	V7	6724	50.971	9	.000	.087
Type of Agency	V9	6724	40.599	7	.000	.078
Fulltime Sworn Personnel	V10	6724	112.921	10	.000	.130
State	V11	6724	220.807	50	.000	.181
Parttime Sworn Personnel	V12	6724	65.610	8	.000	.099
Urban to Rural Continuum	V13	6724	105.161	8	.000	.125
Aggravated Assault	V16	6724	14.486	1	.000	.046
Simple Assault	V17	6724	126.794	1	.000	.137
Bribery	V19	6724	46.927	1	.000	.084
Burglary	V20	6724	13.198	1	.000	.044
Drug/Narcotic violation	V23	6724	78.436	1	.000	.108
Drug Equipment violation	V24	6724	3.841	1	.050	.024
Embezzlement	V25	6724	14.052	1	.000	.046
Extortion	V26	6724	22.444	1	.000	.058
False Pretenses/Swindle	V27	6724	7.341	1	.007	.033
Wire Fraud	V31	6724	16.759	1	.000	.050
Kidnapping/Abduction	V39	6724	21.085	1	.000	.057
Theft from Building	V43	6724	13.043	1	.000	.044
Theft / All Other Larceny	V47	6724	36.182	1	.000	.073
Robbery	V52	6724	24.813	1	.000	.061
Forcible Rape	V53	6724	51.500	1	.000	.088
Forcible Sodomy	V54	6724	13.908	1	.000	.045
Sexual Assault with an Object	V55	6724	6.851	1	.000	.032
Forcible Fondling	V56	6724	111.539	1	.000	.129
Statutory Rape	V58	6724	25.744	1	.000	.062
Online Solicitation of a Child	V60	6724	6.775	1	.000	.032
Other Sex Crime	V61	6724	60.635	1	.000	.095
Stolen Property Offenses	V62	6724	18.218	1	.000	.052
Criminal Civil Rights Violation	V65	6724	40.001	1	.000	.077
Disorderly Conduct	V66	6724	35.365	1	.000	.073

Driving Under the Influence	V67	6724	223.713	1	.000	.182
Drunkenness	V68	6724	6.544	1	.011	.031
Evidence: Destroying/Tampering	V69	6724	6.992	1	.008	.032
False Report / False Statement	V70	6724	4.776	1	.029	.027
Family Offenses, Nonviolent	V71	6724	7.468	1	.006	.033
Hit & Run	V72	6724	5.191	1	.023	.028
Official Misconduct	V75	6724	41.620	1	.000	.079
Gender of Victim	V81	6724	13.138	1	.000	.060
Victim is a Police Officer	V82	6724	5.541	1	.000	.037
Age of Victim	V83	6724	111.533	1	.008	.247
Child Victim	V84	6724	41.756	1	.000	.102
Victim Relationship to the Offender	V85	6724	173.685	1	.000	.210
Organizational vs. Against Citizenry	V90	6724	84.564	1	.000	.112
Internal vs. Organizational	V91	6724	74.138	2	.000	.105
Official Capacity	V92	6724	213.535	1	.000	.178
Drug-related	V93	6724	91.325	1	.000	.117
Alcohol-related	V94	6724	181.978	1	.000	.165
Sex-related	V95	6724	246.197	1	.000	.191
Violence-related	V96	6724	5.439	1	.020	.028
Profit-motivated	V97	6724	162.689	1	.000	.156
Police Sexual Violence	V98	6724	120.585	1	.000	.134
Driving While Female Encounter	V99	6724	63.373	1	.000	.097
Officer was Reassigned	V102	6724	111.394	1	.000	.129
Officer was Demoted	V103	6724	11.856	1	.000	.042
Officer was Suspended	V104	6724	178.976	1	.000	.163
Officer's Chief is Under Scrutiny	V106	6724	4.045	1	.044	.025
DUI-related Traffic Accident	V110	6724	68.821	1	.000	.101
Injuries in DUI-related Traffic Accident	V111	6724	15.669	1	.000	.048
DUI in a Take-home Police Vehicle	V113	6724	4.246	1	.039	.025
DUI in a Police Vehicle Out of Jurisdiction	V114	6724	4.277	1	.039	.025
DUI in a Personally-Owned Vehicle	V115	6724	127.325	1	.000	.138
DUI: Refused Field Sobriety Tests	V116	6724	21.562	1	.000	.057
DUI: Refused BAC Test	V117	6724	27.880	1	.000	.064
Off-Duty: Ordinance re On-Duty 24 Hours	V118	6724	14.671	1	.000	.047
Off-Duty: Showed Police Weapon	V121	6724	17.053	1	.000	.050
Off-Duty: Intervened in Existing Dispute	V125	6724	4.690	1	.000	.026

Family Violence	V126	6724	121.166	1	.000	.134
DUI: Officer Resisted Arrest	V127	6724	6.174	1	.013	.030
DUI: In Possession of Firearm while DUI	V128	6724	7.087	1	.008	.032
Heroin	V129	6724	21.896	1	.000	.057
Hydrocodone	V131	6724	14.659	1	.000	.047
Oxycodone	V133	6724	20.173	1	.000	.055
Other Narcotics	V135	6724	9.726	1	.002	.038
Benzodiazepines	V137	6724	7.020	1	.008	.032
Cocaine	V139	6724	24.365	1	.000	.060
Crack	V140	6724	6.594	1	.010	.031
Amphetamine/Methamphetamine	V141	6724	9.954	1	.002	.038
Marijuana	V148	6724	27.796	1	.000	.064
OIDV: Weapon: Gun - Personally Owned	V157	6724	4.191	1	.041	.025
OIDV: Weapon: Hands/Fist	V164	6724	60.566	1	.000	.095
OIDV: Weapon: Miscellaneous Objects	V166	6724	13.953	1	.000	.046
OIDV: Gun was Confiscated	V168	6724	9.579	1	.002	.038
OIDV: Confiscated Gun was Later Returned	V169	6724	5.859	1	.015	.030
OIDV: Order of Protection Files	V171	6724	5.811	1	.016	.029
OIDV: Victim Injury: Nonfatal	V173	6724	38.573	1	.000	.076
42 USC 1981 Civil Defendant at Some Point	V175	6724	4.963	1	.026	.027
42 USC 1983 Civil Defendant at Some Point	V176	6724	18.643	1	.000	.053
42 USC 1985 Civil Defendant at Some Point	V177	6724	7.043	1	.008	.032
42 USC 1997 Civil Defendant at Some Point	V178	6724	5.469	1	.019	.029
28 USC 1441 Civil Action Removed	V179	6724	17.956	1	.000	.052
Civil Rights Defendant - Aggregate	V180	6724	19.365	1	.000	.054
18 USC 242 Criminal Deprivation of Rights	V181	6724	63.724	1	.000	.097
Most Serious Offense Charged	V183	6724	752.849	1	.000	.335
Drugs: Using / Personal use	V196	6724	15.137	1	.000	.047
Drugs: Selling / Dealing / Trafficking	V197	6724	60.761	1	.000	.095
Drugs: Facilitating Drug Trade	V201	6724	49.058	1	.000	.085
Drugs: Shakedowns from Street Dealers	V202	6724	11.463	1	.001	.041
Drugs: Shakedowns from Radio Runs	V203	6724	4.809	1	.028	.027
Drugs: Shakedowns from Legit Raids/Search	V205	6724	6.345	1	.012	.031
Drugs: Shakedowns from Car Stops	V206	6724	19.536	1	.000	.054
Drugs: Shakedowns from Off-Duty Robbery	V207	6724	11.829	1	.001	.042
Drugs: Theft from Evidence Room	V208	6724	28.799	1	.001	.065

Drugs: Shakedowns - Aggregate	V210	6724	30.844	1	.001	.068
Narcotics	Narcotics	6724	45.919	1	.000	.083
Depressants	Depressants	6724	5.367	1	.021	.028
Stimulants	Stimulants	6724	39.666	1	.000	.077
Cannabis	Cannabis	6724	27.796	1	.000	.064
DUI in a Police Vehicle	DUIPoliceVe	6724	4.610	1	.032	.026
Age Categorical	AgeCat	6724	162.221	10	.000	.155
Years of Service Categorical	YearsServCat	6724	110.430	10	.000	.128
Metro County versus Nonmetro County	CountyDichot	6724	52.989	1	.000	.089
Geographic Region	GeogRegion	6724	39.547	3	.000	.077
Geographic Division	GeogDivision	6724	52.482	8	.000	.088
Rank Function	RankFunction	6724	26.425	2	.000	.063
Victim Age Categorical	VictimAgeCat	6724	53.406	9	.000	.089
Victim Age Difference	VicAgeDiff	6724	162.449	103	.000	.155

Table 7. Logistic Regression Model Predicting Job Loss ($N = 1,288$)

	<i>B</i>	<i>SE</i>	Wald	<i>p</i>	Exp(B)	95% CI for Exp(B)	
						<i>LL</i>	<i>UL</i>
Urban to Rural County Continuum (V13)	0.110	0.053	4.350	.037	1.116	1.007	1.237
Internal versus Organizational Crime (V91)	0.155	0.022	49.935	<.001	1.168	1.119	1.219
Alcohol-related Crime (V94)	0.431	0.173	6.204	.013	1.538	1.096	2.159
Sex-related Crime (V95)	0.857	0.150	32.577	<.001	2.356	1.755	3.162
Police Sexual Violence (V98)	0.548	0.213	6.621	.010	1.730	1.139	2.626
Officer was Reassigned (V102)	-1.062	0.327	10.519	.001	0.346	0.182	0.657
Officer was Suspended (V104)	-0.955	0.153	38.988	<.001	0.385	0.285	0.519
Family Violence (V126)	-0.670	0.158	17.993	<.001	0.512	0.376	0.697
Marijuana (V148)	-3.128	0.778	16.173	<.001	0.044	0.010	0.201
42 USC §1985 Civil Defendant at Some Point (V177)	1.251	0.485	6.670	.010	3.495	1.352	9.036
Geographic Division	0.053	0.026	4.286	.038	1.054	1.003	1.109
- 2 Log Likelihood	1502.588						
Model Chi-Square	241.666			<.001			
Cox & Snell R^2	.171						
Nagelkerke R^2	.231						
ROC R^2	.276						
AUC	.638						
						95% CI for AUC	
						<i>LL</i>	<i>UL</i>
						.625	.652

Table 8. Chi-Square Predicting Sex-Related Police Crime Arrests

Variable Label	Variable	<i>N</i>	χ^2	<i>df</i>	<i>p</i>	<i>V</i>
Years of Service	V4	4780	79.685	43	.001	.129
Gender	V5	6724	87.851	1	.000	.114
Duty Status	V6	6724	16.704	1	.000	.050
Rank	V7	6724	25.566	9	.002	.062
Arson	V15	6724	8.698	1	.003	.036
Aggravated Assault	V16	6724	71.524	1	.000	.103
Simple Assault	V17	6724	150.617	1	.000	.150
Bribery	V19	6724	44.045	1	.000	.081
Burglary	V20	6724	7.159	1	.007	.033
Counterfeiting	V21	6724	16.887	1	.000	.050
Destruction of Property / Vandalism	V22	6724	27.393	1	.000	.064
Drug / Narcotic Violation	V23	6724	115.283	1	.000	.131
Embezzlement	V25	6724	33.883	1	.000	.071
Extortion / Blackmail	V26	6724	4.816	1	.028	.027
False Pretenses / Swindle	V27	6724	68.565	1	.000	.101
Impersonation	V29	6724	6.878	1	.009	.032
Murder & Nonnegligent Manslaughter	V36	6724	31.126	1	.000	.068
Kidnapping / Abduction	V39	6724	142.166	1	.000	.145
Shoplifting	V42	6724	8.980	1	.003	.037
Theft from Building	V43	6724	33.304	1	.000	.070
Theft from Motor Vehicle	V46	6724	6.446	1	.011	.031
Theft / All Other Larceny	V47	6724	71.221	1	.000	.103
Robbery	V52	6724	27.327	1	.000	.064
Stolen Property Offenses	V62	6724	24.250	1	.000	.060
Weapons Law violations	V63	6724	67.587	1	.000	.100
Criminal Civil Rights violations	V65	6724	4.322	1	.038	.025
Disorderly Conduct	V66	6724	17.537	1	.000	.051
Drunkenness	V68	6724	10.320	1	.001	.039
Evidence: Destroying / Tampering	V69	6724	3.975	1	.046	.024
False Report / False Statement	V70	6724	68.564	1	.000	.101
Hit & Run	V72	6724	32.100	1	.000	.069
Obstruction of Justice	V74	6724	11.470	1	.001	.041
Official Misconduct	V75	6724	56.537	1	.000	.092
Peeping Tom	V76	6724	7.163	1	.007	.033

Restraining Order violation	V77	6724	4.596	1	.032	.026
Trespass of Real Property	V78	6724	6.388	1	.011	.031
All Other Offenses	V80	6724	48.023	1	.000	.085
Gender of Victim	V81	3668	651.711	1	.000	.422
Victim is a Police Officer	V82	3967	58.859	1	.000	.122
Age of Victim	V83	1848	592.004	79	.000	.566
Victim is a Child	V84	3990	684.979	1	.000	.414
Relationship of Victim to Offender	V85	3934	909.238	7	.000	.481
Organizational vs. Against Citizenry	V90	6724	182.373	1	.000	.165
Internal vs. Organizational	V91	6724	84.426	2	.000	.112
Official Capacity	V92	6724	8.465	1	.004	.035
Drug-related	V93	6724	137.383	1	.000	.143
Alcohol-related	V94	6724	260.078	1	.000	.197
Violence-related	V96	6724	357.899	1	.000	.231
Profit-motivated	V97	6724	492.036	1	.000	.271
Driving While Female Encounter	V99	6724	587.698	1	.000	.296
Officer was Reassigned	V102	6724	5.261	1	.022	.028
Discussion of Agency Scandal or Cover up	V107	6724	28.459	1	.000	.065
Citizen Complaint as Method of Detection	V108	6724	520.439	1	.000	.278
Off-Duty: 24-Hour Ordinance	V118	6724	3.865	1	.049	.024
Off-Duty: Identified Self as Police Officer	V119	6724	12.151	1	.000	.043
Off-Duty: Showed a Police Weapon	V121	6724	30.300	1	.000	.067
Off-Duty: Flashed Badge	V122	6724	4.592	1	.032	.026
Off-Duty: Conducted a Search	V123	6724	5.322	1	.021	.028
Off-Duty: Made an Arrest	V124	6724	5.884	1	.015	.030
Family Violence	V126	6724	57.839	1	.000	.093
Heroin	V129	6724	8.841	1	.003	.036
Hydrocodone	V131	6724	12.488	1	.000	.043
Oxycodone	V133	6724	25.191	1	.000	.061
Other Narcotics	V135	6724	8.135	1	.000	.035
Benzodiazepines	V137	6724	5.322	1	.021	.028
Cocaine	V139	6724	56.932	1	.000	.092
Crack	V140	6724	11.586	1	.001	.042
Amphetamine / Methamphetamine	V141	6724	12.453	1	.000	.043
Marijuana	V148	6724	19.006	1	.000	.053
Testosterone	V151	6724	4.760	1	.029	.027

Other Anabolic Steroid	V152	6724	5.768	1	.016	.029
OIDV: Weapon: Dept-issued Gun	V156	6724	13.016	1	.000	.044
OIDV: Weapon: Personal Gun	V157	6724	13.098	1	.000	.044
OIDV: Weapon: Hands/Fist	V164	6724	66.856	1	.000	.100
OIDV: Weapon: Other Body parts	V165	6724	54.637	1	.000	.090
OIDV: Weapon: Miscellaneous Objects	V166	6724	13.858	1	.000	.045
OIDV: Verbal Threats & Violent Ultimatums	V167	6724	11.503	1	.001	.041
OIDV: Gun was Confiscated	V168	6724	6.235	1	.013	.030
OIDV: Article Mentions DV gun prohibition	V170	6724	7.923	1	.005	.034
OIDV: Order of Protection Filed	V171	6724	11.052	1	.001	.041
OIDV: Officer Violated Order of Protection	V172	6724	7.700	1	.006	.034
OIDV: Victim Injured, Nonfatal	V173	6724	18.431	1	.000	.052
OIDV: Victim Injured, Fatal	V174	6724	8.698	1	.003	.036
42 USC 1981 Civil Defendant at Some Point	V175	6724	9.284	1	.002	.037
42 USC 1983 Civil Defendant at Some Point	V176	6724	6.376	1	.012	.031
42 USC 1985 Civil Defendant at Some Point	V177	6724	10.874	1	.001	.040
28 USC 1441 Civil Rights Case Removed	V179	6724	10.452	1	.001	.039
Federal Civil Rights Defendant - Aggregate	V180	6724	6.649	1	.010	.031
18 USC 242 Criminal Defendant at Some Pt	V181	6724	4.816	1	.028	.027
Most Serious Offense Charged	V183	6724	5322.861	63	.000	.890
Drugs: Personal Use	V196	6724	57.821	1	.000	.093
Drugs: Selling / Dealing / Trafficking	V197	6724	74.521	1	.000	.105
Drugs: Forge Prescription	V198	6724	9.262	1	.002	.037
Drugs: Sexually-motivated Drug Crime	V199	6724	80.884	1	.000	.110
Drugs: Planting Evidence	V200	6724	9.262	1	.002	.037
Drugs: Facilitating Drug Trade	V201	6724	49.301	1	.000	.086
Drugs: Shakedowns from Street Dealers	V202	6724	21.184	1	.000	.056
Drugs: Shakedowns from Radio Runs	V203	6724	4.479	1	.034	.026
Drugs: Shakedowns from Warrantless Searches	V204	6724	19.472	1	.000	.054
Drugs: Shakedowns from Legit Searches	V205	6724	9.262	1	.002	.037
Drugs: Shakedowns from Car Stops	V206	6724	16.340	1	.000	.049
Drugs: Shakedowns from Off-Duty Robberies	V207	6724	9.827	1	.002	.038
Drugs: Theft from Evidence Room	V208	6724	16.909	1	.000	.050
Drugs: Falsification	V209	6724	15.340	1	.000	.049
Drugs: Shakedowns - Aggregate	V210	6724	49.007	1	.000	.085
Narcotics	Narcotics	6724	44.270	1	.000	.081

Depressants	Depressants	6724	8.026	1	.005	.035
Stimulants	Stimulants	6724	74.783	1	.000	.105
Hallucinogens	Hallucinogens	6724	6.446	1	.011	.031
Cannabis	Cannabis	6724	19.006	1	.000	.053
Anabolic Steroids	AnabolicSter	6724	9.929	1	.002	.038
Age Categorical	AgeCat	6724	105.671	10	.000	.125
Years of Service Categorical	YearsServCat	6724	109.107	10	.000	.127
Geographic Region	GeogRegion	6724	81.554	3	.000	.110
Geographic Division	GeogDivision	6724	106.705	8	.000	.126
Victim Age Categorical	VictimAgeCat	6724	1494.957	9	.000	.472
Victim Age Difference	VictimAgeDif	6724	1406.902	103	.000	.457

Table 9. Logistic Regression Model Predicting Sex-related Cases (N = 1,809)

	<i>B</i>	<i>SE</i>	Wald	<i>p</i>	Exp(B)	95% CI for Exp(B)	
						<i>LL</i>	<i>UL</i>
Duty Status (V6)	0.451	0.191	5.580	.018	1.570	1.080	2.282
Gender of Victim (V81)	-3.476	0.189	338.398	<.001	0.031	0.021	0.045
Child Victim (V84)	1.895	0.199	90.357	<.001	6.654	4.502	9.835
Victim Relationship to Offender (V85)	0.342	0.076	20.302	<.001	1.407	1.213	1.633
Alcohol-related Crime (V94)	-1.403	0.251	31.300	<.001	0.246	0.150	0.402
Profit-motivated Crime (V97)	-2.175	0.624	12.156	<.001	0.114	0.033	0.386
Agency Scandal / Cover up (V107)	-0.851	0.365	5.423	.020	0.427	0.209	0.874
Citizen Complaint as Method of Crime Detection (V108)	1.981	0.224	78.517	<.001	7.247	4.676	11.230
Off-Duty: Identified Self as an Officer (V119)	-1.114	0.412	7.308	.007	0.328	0.146	0.736
Family Violence (V126)	-1.320	0.343	14.793	<.001	0.267	0.136	0.524
OIDV: Weapon: Hands/Fist (V164)	-1.470	0.394	13.955	<.001	0.230	0.106	0.497
OIDV: Weapon: Miscellaneous Objects (V166)	-3.012	0.879	11.737	.001	0.049	0.009	0.276
42 USC §1983 Civil Defendant at Some Point (V176)	-0.724	0.184	15.493	<.001	0.485	0.338	0.695
Victim Age Difference	0.055	0.006	72.946	<.001	1.056	1.043	1.069
- 2 Log Likelihood	1051.788						
Model Chi-Square	1433.190			<.001			
Cox & Snell R^2	.547						
Nagelkerke R^2	.733					95% CI for AUC	
ROC R^2	.878					<i>LL</i>	<i>UL</i>
AUC	.939					.931	.947

Table 10. Chi-Square Predicting Alcohol-related Police Crime Arrests

Variable Label	Variable	<i>N</i>	χ^2	<i>df</i>	<i>p</i>	<i>V</i>
Age	V3	5863	89.049	56	.003	.123
Duty Status	V6	6724	630.074	1	.000	.306
Type of Agency	V9	6724	23.819	7	.001	.060
FT Sworn Categorical	V10	6724	34.433	10	.000	.072
State	V11	6724	182.106	50	.000	.165
Arresting Agency	V14	6724	25.529	1	.000	.062
Arson	V15	6724	5.855	1	.016	.030
Simple Assault	V17	6724	10.496	1	.001	.040
Intimidation	V18	6724	50.668	1	.000	.087
Bribery	V19	6724	39.829	1	.000	.077
Burglary	V20	6724	22.387	1	.000	.058
Counterfeiting/Forgery	V21	6724	20.501	1	.000	.055
Property Damage / Vandalism	V22	6724	9.494	1	.002	.038
Drug / Narcotic Violation	V23	6724	111.902	1	.000	.129
Embezzlement	V25	6724	34.343	1	.000	.071
Extortion / Blackmail	V26	6724	34.669	1	.000	.072
False Pretenses / Swindle	V27	6724	66.634	1	.000	.100
Credit Card / ATM Fraud	V28	6724	5.544	1	.000	.029
Impersonation	V29	6724	8.144	1	.004	.035
Wire Fraud	V31	6724	8.197	1	.004	.035
Kidnapping / Abduction	V39	6724	22.804	1	.000	.058
Shoplifting	V42	6724	8.463	1	.004	.035
Theft from Building	V43	6724	28.843	1	.000	.065
Theft from Motor Vehicle	V45	6724	6.074	1	.014	.030
Theft / All Other Larceny	V47	6724	73.232	1	.000	.104
Pornography	V49	6724	19.694	1	.000	.054
Prostitution	V50	6724	10.571	1	.001	.040
Assisting or Promoting Prostitution	V51	6724	4.312	1	.038	.025
Robbery	V52	6724	27.760	1	.000	.064
Forcible Rape	V53	6724	35.279	1	.000	.072
Forcible Sodomy	V54	6724	25.952	1	.000	.062
Forcible Fondling	V56	6724	70.116	1	.000	.102
Statutory Rape	V58	6724	23.282	1	.000	.059
Indecent Exposure	V59	6724	4.173	1	.041	.025

Online Solicitation of a Child	V60	6724	11.504	1	.001	.041
Other Sex Crime	V61	6724	25.129	1	.000	.061
Stolen Property Offenses	V62	6724	27.531	1	.000	.064
Criminal Civil Rights violation	V65	6724	41.862	1	.000	.079
Disorderly Conduct	V66	6724	33.555	1	.000	.071
Evidence: Destroying / Tampering	V69	6724	15.061	1	.000	.047
False Report / False Statement	V70	6724	71.120	1	.000	.103
Hit & Run	V72	6724	240.993	1	.000	.189
Obstruction of Justice	V74	6724	27.167	1	.000	.064
Official Misconduct	V75	6724	197.410	1	.000	.171
Restraining Order violation	V77	6724	7.940	1	.005	.034
Gender of the Victim	V81	3668	20.668	1	.000	.075
Victim is a Police Officer	V82	3967	25.498	1	.000	.080
Age of Victim	V83	1848	172.884	79	.000	.306
Victim is a Child	V84	3990	46.606	1	.000	.108
Victim Relationship to the Offender	V85	3934	74.902	7	.000	.138
Organizational vs. Against Citizenry	V90	6724	656.028	1	.000	.312
Internal vs. Organizational	V91	6724	957.118	2	.000	.377
Official Capacity	V92	6724	619.269	1	.000	.303
Drug-related	V93	6724	124.399	1	.000	.136
Sex-related	V95	6724	259.429	1	.000	.196
Violence-related	V96	6724	199.445	1	.000	.172
Profit-motivated	V97	6724	498.804	1	.000	.272
Police Sexual Violence	V98	6724	100.204	1	.000	.122
Driving While Female Encounter	V99	6724	24.961	1	.000	.061
Officer was Reassigned to Another Position	V102	6724	52.795	1	.000	.089
Officer was Demoted in Rank	V103	6724	10.025	1	.002	.039
Officer was Suspended	V104	6724	23.848	1	.000	.060
Discussion of Agency Scandal or Cover up	V107	6724	21.420	1	.000	.056
Citizen Complaint as Method of Detection	V108	6724	109.416	1	.000	.128
Off-Duty: 24-Hour Ordinance	V118	6724	64.099	1	.000	.098
Off-Duty: Identified Self as Police Officer	V119	6724	69.862	1	.000	.102
Off-Duty: In Police Uniform	V120	6724	7.750	1	.005	.034
Off-Duty: Flashed Badge	V122	6724	13.457	1	.000	.045
Family Violence	V126	6724	50.784	1	.000	.087
Heroin	V129	6724	12.770	1	.000	.044

Hydrocodone	V131	6724	18.415	1	.000	.052
Oxycodone	V133	6724	21.331	1	.000	.056
Cocaine	V139	6724	46.465	1	.000	.083
Crack	V140	6724	13.009	1	.000	.044
Amphetamine / Methamphetamine	V141	6724	11.678	1	.000	.042
Marijuana	V148	6724	21.913	1	.000	.057
Testosterone	V151	6724	4.502	1	.034	.026
Other Anabolic Steroids	V152	6724	5.364	1	.021	.028
OIDV: Weapon: Hands/Fist	V164	6724	17.435	1	.000	.051
OIDV: Weapon: Miscellaneous Object	V166	6724	5.920	1	.015	.030
OIDV: Verbal Threats or Violent Ultimatum	V167	6724	6.447	1	.011	.031
OIDV: Gun was Confiscated	V168	6724	4.227	1	.040	.025
OIDV: Order of Protection Filed	V171	6724	8.370	1	.004	.035
OIDV: Officer Violated Order of Protection	V172	6724	9.560	1	.002	.038
OIDV: Victim Injured: Nonfatal	V173	6724	23.276	1	.000	.059
OIDV: Victim Injured: Fatal	V174	6724	5.883	1	.015	.030
42 U.S.C. 1983 Defendant at Some Point	V176	6724	42.196	1	.000	.079
42 U.S.C. 1985 Defendant at Some Point	V177	6724	6.191	1	.013	.030
42 U.S.C. 1997 Plaintiff is a Prisoner	V178	6724	12.140	1	.000	.042
28 U.S.C. 1441 Civil Rights Case Removed	V179	6724	9.198	1	.002	.037
Federal Civil Rights Defendant - Aggregate	V180	6724	38.788	1	.000	.076
18 U.S.C. 242 Criminal Defendant	V181	6724	26.456	1	.000	.063
Most Serious Offense Charged	V183	6724	3906.421	63	.000	.762
Drugs: Using / Personal Use	V196	6724	25.808	1	.000	.062
Drugs: Selling / Dealing / Trafficking	V197	6724	80.031	1	.000	.109
Drugs: Forged Prescription	V198	6724	8.760	1	.003	.036
Drugs: Planting Evidence	V200	6724	8.760	1	.003	.036
Drugs: Facilitating Drug Trade	V201	6724	46.626	1	.000	.083
Drugs: Shakedowns from Street Dealers	V202	6724	20.035	1	.000	.055
Drugs: Shakedowns from Radio Runs	V203	6724	4.236	1	.040	.025
Drugs: Shakedowns from Warrantless Search	V204	6724	18.415	1	.000	.052
Drugs: Shakedowns from Legit Search/Raids	V205	6724	8.760	1	.003	.036
Drugs: Shakedowns from Car Stops / Couriers	V206	6724	15.454	1	.000	.048
Drugs: Shakedowns from Off-Duty Robberies	V207	6724	9.294	1	.002	.037
Drugs: Theft from Evidence Room	V208	6724	13.542	1	.000	.045
Drugs: Falsification	V209	6724	15.454	1	.000	.048

Drugs: Shakedowns - Aggregate	V210	6724	46.348	1	.000	.083
Narcotics	Narcotics	6724	46.079	1	.000	.083
Stimulants	Stimulants	6724	65.383	1	.000	.099
Cannabis	Cannabis	6724	21.913	1	.000	.057
Anabolic Steroids	AnabolicSter	6724	9.292	1	.002	.037
Age Categorical	AgeCat	6724	43.280	10	.000	.080
Geographic Region	GeogRegion	6724	31.558	3	.000	.069
Geographic Division	GeogDivision	6724	40.663	8	.000	.078
Age of Victim Categorical	VicAgeCat	6724	102.029	9	.000	.123
Victim Age Difference	VicAgeDiff	6724	144.561	103	.004	.147

Table 11. Logistic Regression Model Predicting Alcohol-related Arrest Cases ($N = 3,248$)

	<i>B</i>	<i>SE</i>	Wald	<i>p</i>	Exp(B)	95% CI for Exp(B)	
						<i>LL</i>	<i>UL</i>
Duty Status (V6)	-2.511	0.183	189.197	<.001	0.081	0.057	0.116
Child Victim (V84)	-1.323	0.219	36.481	<.001	0.266	0.173	0.409
Victim Relationship to Offender (V85)	0.161	0.025	42.205	<.001	1.175	1.119	1.234
Organizational Crime versus Against Citizenry (V90)	-1.339	0.245	29.768	<.001	0.262	0.162	0.424
Sex-related Crime (V95)	-1.359	0.210	41.766	<.001	0.257	0.170	0.388
Violence-related Crime (V96)	-0.352	0.163	4.656	.031	0.703	0.511	0.968
Police Sexual Violence (V98)	0.974	0.277	12.401	<.001	2.649	1.540	4.557
Suspended (V104)	0.458	0.131	12.246	<.001	1.581	1.223	2.044
Agency Scandal/ Cover Up (V107)	0.780	0.254	9.420	.002	2.181	1.326	3.589
Citizen Complaint as Method of Crime Detection (V108)	-0.339	0.140	5.882	.015	0.713	0.542	0.937
Off-Duty: In Uniform (V120)	-2.421	1.040	5.421	.020	0.089	0.012	0.682
Marijuana (V148)	1.792	0.512	12.247	<.001	6.000	2.200	16.369
OIDV: Victim Injured, Fatal (V174)	-2.073	1.032	4.037	.045	0.126	0.017	0.951
42 USC §1997 Civil Defendant at Some Point (V178)	-0.626	0.307	4.162	.041	0.535	0.293	0.976
18 USC §242 Criminal Defendant at Some Point (V181)	-1.253	0.574	4.768	.029	0.286	0.093	0.880
Most Serious Offense Charged (V183)	0.012	0.003	16.185	<.001	1.012	1.006	1.018
Victim Age Difference	0.018	0.005	14.298	<.001	1.018	1.009	1.028
- 2 Log Likelihood	2102.385						
Model Chi-Square	532.900			<.001			
Cox & Snell R^2	.151						
Nagelkerke R^2	.272						
ROC R^2	.604						
AUC	.802						
						95% CI for AUC	
						<i>LL</i>	<i>UL</i>
						.781	.823

Table 12. Chi-Square Predicting Drug-related Police Crime Arrests

Variable Label	Variable	N	χ^2	df	p	V
Age	V3	5863	87.066	56	.005	.122
Duty Status	V6	6724	116.700	1	.000	.132
Rank	V7	6724	34.999	9	.000	.072
Fulltime Sworn Personnel Categorical	V10	6724	29.917	10	.001	.067
State	V11	6724	100.646	50	.000	.122
Arresting Agency	V14	6724	9.770	1	.002	.038
Aggravated Assault	V16	6724	44.880	1	.000	.082
Simple Assault	V17	6724	130.214	1	.000	.139
Intimidation	V18	6724	17.812	1	.000	.051
Burglary	V20	6724	16.056	1	.000	.049
Counterfeiting/Forgery	V21	6724	5.766	1	.016	.029
Extortion	V26	6724	62.225	1	.000	.096
Murder & Nonnegligent Manslaughter	V36	6724	8.114	1	.004	.035
Negligent Manslaughter	V37	6724	8.469	1	.004	.035
Shoplifting	V42	6724	3.964	1	.046	.024
Theft from Building	V43	6724	60.149	1	.000	.095
Pornography	V49	6724	4.434	1	.035	.026
Robbery	V52	6724	236.476	1	.000	.188
Forcible Rape	V53	6724	23.288	1	.000	.059
Forcible Sodomy	V54	6724	10.810	1	.001	.040
Forcible Fondling	V56	6724	38.806	1	.000	.076
Statutory Rape	V58	6724	14.219	1	.000	.046
Indecent Exposure	V59	6724	8.973	1	.003	.037
Online Solicitation of a Child	V60	6724	5.492	1	.019	.029
Other Sex Crime	V61	6724	16.635	1	.000	.050
Weapons Law violation	V63	6724	62.083	1	.000	.096
Criminal Deprivation of Civil Rights	V65	6724	22.141	1	.000	.057
Disorderly Conduct	V66	6724	17.395	1	.000	.051
Driving Under the Influence	V67	6724	43.269	1	.000	.080
Evidence: Destroying / Tampering	V69	6724	53.036	1	.000	.089
False Report / False Statement	V70	6724	8.320	1	.004	.035
Hit & Run	V72	6724	5.154	1	.023	.028
Liquor Law violation	V73	6724	5.460	1	.019	.028
Obstruction of Justice	V74	6724	31.418	1	.000	.068

Official Misconduct	V75	6724	6.881	1	.009	.032
Restraining Order violation	V77	6724	4.836	1	.028	.027
Gender of Victim	V81	3668	8.658	1	.003	.049
Age of Victim	V83	1848	140.050	79	.000	.275
Child Victim	V84	3990	15.568	1	.000	.062
Victim Relationship to Offender	V85	3994	35.490	7	.000	.095
Organizational vs. Against Citizenry	V90	6724	5.101	1	.024	.028
Internal vs. Organizational	V91	6724	96.522	2	.000	.120
Official Capacity	V92	6724	102.216	1	.000	.123
Alcohol-related	V94	6724	124.351	1	.000	.136
Sex-related	V95	6724	138.637	1	.000	.144
Violence-related	V96	6724	331.322	1	.000	.222
Profit-motivated	V97	6724	580.101	1	.000	.294
Police Sexual Violence	V98	6724	51.585	1	.000	.088
Driving While Female Encounter	V99	6724	14.751	1	.000	.047
Officer was Reassigned	V102	6724	11.040	1	.001	.041
Officer was Suspended	V104	6724	16.627	1	.000	.050
Officer's Supervisor was Disciplined	V105	6724	19.700	1	.000	.054
Officer's Chief is Under Scrutiny	V106	6724	7.017	1	.008	.032
Discussion of Agency Scandal / Cover Up	V107	6724	97.812	1	.000	.121
Citizen Complaint as Method of Detection	V108	6724	262.034	1	.000	.197
DUI-related Traffic Accident	V110	6724	10.393	1	.001	.039
Injuries in DUI-related Traffic Accident	V111	6724	10.301	1	.001	.039
DUI On-Duty in Police Vehicle	V112	6724	18.624	1	.000	.053
DUI in Personally-owned Vehicle	V115	6724	34.411	1	.000	.072
DUI: Refused Field Sobriety Tests	V116	6724	6.072	1	.014	.030
DUI: Refused BAC Tests	V117	6724	16.369	1	.000	.049
Off-Duty: Identified Self as Police Officer	V119	6724	10.626	1	.001	.040
Off-Duty: Showed Police Weapon	V121	6724	12.705	1	.000	.043
Off-Duty: Conducted a Search	V123	6724	4.589	1	.032	.026
Family Violence	V126	6724	106.902	1	.000	.126
OIDV: Weapon: Dept-issued Gun	V156	6724	4.759	1	.029	.027
OIDV: Weapon: Personal Gun	V157	6724	6.671	1	.010	.031
OIDV: Weapon: Hands / Fist	V164	6724	56.065	1	.000	.091
OIDV: Weapon: Miscellaneous Objects	V166	6724	7.093	1	.008	.032
OIDV: Verbal Threats / Violent Ultimatums	V167	6724	9.526	1	.002	.038

OIDV: Gun was Confiscated	V168	6724	10.836	1	.001	.040
OIDV: Article Mentions Gun Prohibition	V170	6724	4.395	1	.036	.026
OIDV: Order of Protection Files	V171	6724	15.025	1	.000	.047
OIDV: Officer Violated Order of Protection	V172	6724	4.462	1	.035	.026
OIDV: Victim Injured, Nonfatal	V173	6724	45.203	1	.000	.082
OIDV: Victim Injured, Fatal	V174	6724	3.840	1	.050	.240
42 U.S.C. 1983 Civil Defendant at Some Point	V176	6724	25.553	1	.000	.062
42 U.S.C. 1985 Civil Defendant at Some Point	V177	6724	53.326	1	.000	.089
42 U.S.C. 1997 Civil Defendant at Some Point	V178	6724	38.431	1	.000	.076
28 U.S.C. 1441 Civil Rights Case Removed	V179	6724	6.848	1	.009	.032
Federal Civil Rights Defendant - Aggregate	V180	6724	25.441	1	.000	.062
18 U.S.C. 242 Criminal Defendant	V181	6724	10.281	1	.001	.039
Most Serious Offense Charged	V183	6724	3127.330	63	.000	.682
Age Categorical	AgeCat	6724	52.409	10	.000	.088
Geographic Division	GeogDiv	6724	22.297	8	.004	.058
Rank by Function	RankFunc	6724	8.329	2	.016	.035
Victim Age Categorical	VicAgeCat	6724	209.599	9	.000	.177
Victim Age Difference	VicAgeD	6724	217.928	103	.000	.180

Table 13. Logistic Regression Model Predicting Drug-related Arrest Cases ($N = 1,697$)

	<i>B</i>	<i>SE</i>	Wald	<i>p</i>	Exp(B)	95% CI for Exp(B)	
						<i>LL</i>	<i>UL</i>
State (V11)	-0.048	0.015	10.621	.001	0.953	0.926	0.981
Pornography (V49)	2.344	0.538	18.979	<.001	10.418	3.630	29.902
Forcible Rape (V53)	1.107	0.522	4.496	.034	3.026	1.087	8.422
False Report / False Statement (V70)	2.818	0.592	22.665	<.001	16.742	5.248	53.414
Obstruction of Justice (V74)	2.590	0.558	21.503	<.001	13.324	4.459	39.807
Alcohol-related Crime (V94)	1.532	0.507	9.125	.003	4.626	1.712	12.496
Sex-related Crime (V95)	1.396	0.563	6.149	.013	4.040	1.340	12.180
Profit-motivated Crime (V97)	3.629	0.691	27.598	<.001	37.691	9.731	145.984
Officer was Reassigned (V102)	1.374	0.674	4.154	.042	3.951	1.054	14.812
Injuries in DUI-related Traffic Accident (V111)	1.561	0.746	4.375	.036	4.764	1.103	20.569
- 2 Log Likelihood	254.464						
Model Chi-Square	94.190			<.001			
Cox & Snell R^2	.054						
Nagelkerke R^2	.291						
ROC R^2	.290						
AUC	.645						
						95% CI for AUC	
						<i>LL</i>	<i>UL</i>
						.622	.668

Table 14. Chi-Square Predicting Violence-related Police Crime Arrests

Variable Label	Variable	N	χ^2	df	p	V
Age	V3	5863	111.463	56	.000	.138
Years of Service	V4	4780	81.581	43	.000	.131
Gender	V5	6724	26.172	1	.000	.062
Duty Status	V6	6724	107.403	1	.000	.126
Rank	V7	6724	82.183	9	.000	.111
Type of Agency	V9	6724	22.106	7	.002	.057
Full-Time Sworn Personnel - Categorical	V10	6724	33.913	10	.000	.071
State	V11	6724	133.605	50	.000	.141
Urban / Rural Continuum	V13	6724	31.404	8	.000	.068
Arresting Agency	V14	6724	27.106	1	.000	.063
Intimidation	V18	6724	223.928	1	.000	.182
Bribery	V19	6724	8.133	1	.004	.035
Counterfeiting / Forgery	V21	6724	72.379	1	.000	.104
Destruction of Property / Vandalism	V22	6724	21.213	1	.000	.056
Drug / Narcotic violation	V23	6724	296.215	1	.000	.210
Drug Equipment violation	V24	6724	18.245	1	.000	.052
Embezzlement	V25	6724	116.048	1	.000	.131
Extortion / Blackmail	V26	6724	47.265	1	.000	.084
False Pretenses / Swindle	V27	6724	233.199	1	.000	.186
Credit Card / ATM Fraud	V28	6724	16.863	1	.000	.050
Impersonation	V29	6724	31.433	1	.000	.068
Wire Fraud	V31	6724	26.671	1	.000	.063
Gambling: Betting / Wagering	V32	6724	3.922	1	.048	.024
Gambling: Operating / Promoting	V33	6724	11.781	1	.001	.042
Murder & Nonnegligent Manslaughter	V36	6724	57.019	1	.000	.092
Negligent Manslaughter	V37	6724	13.992	1	.000	.046
Kidnapping / Abduction	V39	6724	197.344	1	.000	.171
Shoplifting	V42	6724	31.509	1	.000	.068
Theft from Building	V43	6724	103.792	1	.000	.124
Theft from Motor Vehicle	V45	6724	22.617	1	.000	.058
Theft: All Other Larceny	V47	6724	251.356	1	.000	.193
Pornography	V49	6724	30.348	1	.000	.067
Prostitution	V50	6724	19.132	1	.000	.053

Assisting or Promoting Prostitution	V51	6724	6.525	1	.011	.031
Stolen Property Offenses	V62	6724	72.860	1	.000	.104
Weapons Law violation	V63	6724	13.850	1	.000	.045
Criminal Deprivation of Civil Rights	V65	6724	30.259	1	.000	.067
Disorderly Conduct	V66	6724	109.947	1	.000	.128
Driving Under the Influence	V67	6724	678.239	1	.000	.318
Evidence: Destroying / Tampering	V69	6724	43.248	1	.000	.080
False Report / False Statement	V70	6724	95.618	1	.000	.119
Hit & Run	V72	6724	39.878	1	.000	.077
Liquor Law violation	V73	6724	22.781	1	.000	.058
Obstruction of Justice	V74	6724	18.982	1	.000	.053
Official Misconduct	V75	6724	10.967	1	.001	.040
Restraining Order Violation	V77	6724	11.806	1	.001	.042
Trespass of Real Property	V78	6724	18.916	1	.000	.053
All Other Offenses	V80	6724	23.533	1	.000	.059
Gender of Victim	V81	3668	4.806	1	.028	.036
Victim is a Police Officer	V82	3967	5.895	1	.015	.039
Age of Victim	V83	1848	166.314	79	.000	.300
Child Victim	V84	3990	21.316	1	.000	.073
Victim Relationship to Offender	V85	3934	206.633	7	.000	.229
Organizational vs. Against Citizenry	V90	6724	332.506	1	.000	.222
Internal vs. Organizational	V91	6724	316.816	2	.000	.217
Official Capacity	V92	6724	41.853	1	.000	.079
Drug-related	V93	6724	331.322	1	.000	.222
Alcohol-related	V94	6724	199.445	1	.000	.172
Sex-related	V95	6724	357.899	1	.000	.231
Profit-motivated	V97	6724	1280.268	1	.000	.436
Driving While Female Encounter	V99	6724	110.448	1	.000	.128
Officer was Suspended	V104	6724	33.976	1	.000	.071
Officer's Chief is Under Scrutiny	V106	6724	4.688	1	.030	.026
Discussion of Agency Scandal / Cover Up	V107	6724	10.187	1	.001	.039
Citizen Complaint as Method of Detection	V108	6724	1327.054	1	.000	.444
DUI-related Traffic Accident	V110	6724	280.360	1	.000	.204
Injuries in a DUI-related Traffic Accident	V111	6724	65.197	1	.000	.098
DUI On-Duty in a Police Vehicle	V112	6724	39.546	1	.000	.077
DUI in a Take-home Police Vehicle	V113	6724	62.541	1	.000	.096

DUI in Police Vehicle Out of Jurisdiction	V114	6724	26.671	1	.000	.063
DUI in a Personally-owned Vehicle	V115	6724	330.073	1	.000	.222
DUI: Refused Field Sobriety Tests	V116	6724	51.479	1	.000	.087
DUI: Refused BAC Tests	V117	6724	123.689	1	.000	.136
Off-Duty: 24-Hour Ordinance	V118	6724	6.828	1	.009	.032
Off-Duty: Identified Self as Police Officer	V119	6724	28.844	1	.000	.065
Off-Duty: Showed a Police Weapon	V121	6724	199.916	1	.000	.172
Off-Duty: Flashed Badge	V122	6724	11.715	1	.001	.042
Off-Duty: Conducted a Search	V123	6724	4.460	1	.035	.026
Off-Duty: Made an Arrest	V124	6724	17.634	1	.000	.051
DUI: In Possession of a Firearm	V128	6724	41.105	1	.000	.078
Heroin	V129	6724	28.330	1	.000	.065
Morphine	V130	6724	4.385	1	.036	.026
Hydrocodone	V131	6724	40.060	1	.000	.077
Hydromorphone	V132	6724	4.904	1	.027	.027
Oxycodone	V133	6724	49.756	1	.000	.086
Other Narcotics	V135	6724	28.542	1	.000	.065
Benzodiazepines	V137	6724	11.575	1	.001	.041
Other Depressants	V138	6724	12.148	1	.000	.043
Cocaine	V139	6724	68.269	1	.000	.101
Crack	V140	6724	39.100	1	.000	.076
Amphetamine / Methamphetamine	V141	6724	41.062	1	.000	.078
Other Stimulants	V143	6724	3.922	1	.048	.024
MDMA & Analogs	V144	6724	10.797	1	.001	.040
Phencyclidine & Analogs	V146	6724	7.849	1	.005	.034
Other Hallucinogens	V147	6724	3.922	1	.048	.024
Marijuana	V148	6724	32.825	1	.000	.070
Testosterone	V151	6724	16.702	1	.000	.050
Other Anabolic Steroids	V152	6724	17.858	1	.000	.052
42 USC 1981 Civil Defendant at Some Point	V175	6724	22.193	1	.000	.057
42 USC 1983 Civil Defendant at Some Point	V176	6724	103.675	1	.000	.124
28 USC 1441 Civil Rights Case Removed	V179	6724	52.819	1	.000	.089
Federal Civil Rights Defendant - Aggregate	V180	6724	104.219	1	.000	.124
18 USC 242 Criminal Defendant	V181	6724	26.437	1	.000	.063
Most Serious Offense Charged	V183	6724	4883.929	63	.000	.852
Drugs: Using / Personal Use	V196	6724	160.243	1	.000	.154

Drugs: Selling / Dealing / Trafficking	V197	6724	151.410	1	.000	.150
Drugs: Forged Prescription	V198	6724	32.499	1	.000	.070
Drugs: Sexually-motivated Drug Crime	V199	6724	7.052	1	.008	.032
Drugs: Planting Evidence	V200	6724	25.027	1	.000	.061
Drugs: Facilitating Drug Trade	V201	6724	114.069	1	.000	.130
Drugs: Shakedown from Radio Runs	V203	6724	11.998	1	.001	.042
Drugs: Shakedown from Warrantless Search	V204	6724	6.895	1	.009	.032
Drugs: Shakedown from Legit Raid/Search	V205	6724	21.657	1	.000	.057
Drugs: Shakedown from Car Stops	V206	6724	7.371	1	.007	.033
Drugs: Theft from Evidence Room	V208	6724	51.606	1	.000	.088
Drugs: falsification	V209	6724	32.781	1	.000	.070
Narcotics	Narcotics	6724	135.577	1	.000	.142
Depressants	Depress	6724	26.700	1	.000	.063
Stimulants	Stimula	6724	118.852	1	.000	.133
Hallucinogens	Hallucino	6724	22.617	1	.000	.058
Cannabis	Cannabis	6724	32.825	1	.000	.070
Anabolic Steroids	AnabSter	6724	32.269	1	.000	.069
DUI in a Police Vehicle	DUIinaP	6724	108.082	1	.000	.127
Age Categorical	AgeCat	6724	43.530	10	.000	.080
Years of Service Categorical	YrsServCa	6724	44.068	10	.000	.081
Metro vs. Nonmetro County	CountyDi	6724	13.247	1	.000	.044
Geographic Region	GeogReg	6724	21.266	3	.000	.056
Geographic Division	GeogDiv	6724	33.277	8	.000	.070
Rank by Function	RankFunc	6724	47.771	2	.000	.084
Victim Age Categorical	VicAgeCat	6724	944.302	9	.000	.375
Victim Age Difference	VicAgeDif	6724	879.176	103	.000	.362

Table 15. Logistic Regression Model Predicting Violence-related Arrest Cases ($N = 1,286$)

	<i>B</i>	<i>SE</i>	Wald	<i>p</i>	Exp(B)	95% CI for Exp(B)	
						<i>LL</i>	<i>UL</i>
Age (V3)	0.057	0.016	13.075	<.001	1.058	1.026	1.092
Years of Service (V4)	-0.040	0.017	5.230	.022	0.961	0.929	0.994
Type of Agency (V9)	0.163	0.080	4.143	.042	1.177	1.006	1.376
Child Victim (V84)	-1.277	0.217	34.716	<.001	0.279	0.182	0.427
Victim Relationship to Offender (V85)	-0.325	0.108	9.107	.003	0.723	0.585	0.892
Internal versus Organizational Crime (V91)	0.064	0.026	6.239	.012	1.066	1.014	1.121
Profit-motivated Crime (V97)	-3.998	0.477	70.258	<.001	0.018	0.007	0.047
Suspended (V104)	0.400	0.178	5.038	.025	1.492	1.052	2.115
Citizen Complaint as Method of Crime Detection (V108)	0.820	0.194	17.867	<.001	2.271	1.552	3.322
DUI-related Traffic Accident (V110)	-2.287	0.303	56.845	<.001	0.102	0.056	0.184
Most Serious Offense Charged (V183)	-0.054	0.006	84.071	<.001	0.948	0.937	0.959
- 2 Log Likelihood	948.709						
Model Chi-Square	378.310			<.001			
Cox & Snell R^2	.255						
Nagelkerke R^2	.396						
ROC R^2	.688						
AUC	.844						
						95% CI for AUC	
						<i>LL</i>	<i>UL</i>
						.826	.862

Table 16. Chi-Square Predicting Profit-Motivated Police Crime Arrests

Variable Label	Variable	<i>N</i>	χ^2	<i>df</i>	<i>p</i>	<i>V</i>
Age	V3	5863	105.411	56	.000	.134
Years of Service	V4	4780	85.616	43	.000	.134
Duty Status	V6	6724	633.147	1	.000	.307
Rank	V7	6724	55.541	9	.000	.091
Full-Time Sworn Categorical	V10	6724	28.640	10	.001	.065
State	V11	6724	244.278	50	.000	.191
Part-Time Sworn Categorical	V12	6724	17.341	8	.027	.051
Urban to Rural Continuum	V13	6724	32.193	8	.000	.069
Arson	V15	6724	5.758	1	.016	.029
Aggravated Assault	V16	6724	171.383	1	.000	.160
Simple Assault	V17	6724	348.894	1	.000	.228
Intimidation	V18	6724	53.258	1	.000	.089
Burglary	V20	6724	72.653	1	.000	.104
Property Destruction / Vandalism	V22	6724	22.339	1	.000	.058
Drug / Narcotic violation	V23	6724	506.835	1	.000	.275
Impersonation	V29	6724	65.165	1	.000	.098
Murder & Nonnegligent Manslaughter	V36	6724	27.881	1	.000	.064
Negligent Manslaughter	V37	6724	21.292	1	.000	.056
Kidnapping / Abduction	V39	6724	22.070	1	.000	.057
Pornography	V49	6724	41.733	1	.000	.079
Prostitution	V50	6724	10.476	1	.001	.039
Forcible Rape	V53	6724	105.167	1	.000	.125
Forcible Sodomy	V54	6724	49.453	1	.000	.086
Sexual Assault with an Object	V55	6724	7.778	1	.005	.034
Forcible Fondling	V56	6724	171.962	1	.000	.160
Incest	V57	6724	4.348	1	.037	.025
Statutory Rape	V58	6724	46.582	1	.000	.083
Indecent Exposure	V59	6724	22.558	1	.000	.058
Online Solicitation of a Child	V60	6724	19.080	1	.000	.053
Other Sex Crime	V61	6724	57.460	1	.000	.092
Weapons Law violation	V63	6724	37.793	1	.000	.075
Criminal Deprivation of Civil Rights	V65	6724	38.249	1	.000	.075
Disorderly Conduct	V66	6724	52.056	1	.000	.088

Driving Under the Influence	V67	6724	357.196	1	.000	.230
Drunkenness	V68	6724	19.080	1	.000	.053
Evidence: Destroying / Tampering	V69	6724	35.334	1	.000	.072
False Report / False Statement	V70	6724	64.682	1	.000	.098
Family Offenses, Nonviolent	V71	6724	5.688	1	.017	.029
Hit & Run	V72	6724	35.944	1	.000	.073
Liquor Law violation	V73	6724	11.217	1	.001	.041
Obstruction of Justice	V74	6724	6.803	1	.009	.032
Official Misconduct	V75	6724	98.591	1	.000	.121
Restraining Order Violation	V77	6724	12.159	1	.000	.043
Trespass of Real Property	V78	6724	11.698	1	.000	.042
Gender of Victim	V81	3668	144.140	1	.000	.198
Victim is a Police Officer	V82	3967	4.800	1	.028	.035
Age of Victim	V83	1848	211.386	79	.000	.338
Victim is a Child	V84	3990	110.187	1	.000	.166
Victim Relationship to the Offender	V85	3934	235.591	7	.000	.245
Organizational vs. Against Citizenry	V90	6724	11.310	1	.001	.041
Internal vs. Organizational	V91	6724	605.995	2	.000	.300
Official Capacity	V92	6724	540.962	1	.000	.284
Drug-related	V93	6724	580.101	1	.000	.294
Alcohol-related	V94	6724	498.804	1	.000	.272
Sex-related	V95	6724	492.371	1	.000	.271
Violence-related	V96	6724	1280.268	1	.000	.436
Police Sexual Violence	V98	6724	182.244	1	.000	.165
Driving While Female Encounter	V99	6724	52.721	1	.000	.089
Officer was Reassigned	V102	6724	31.477	1	.000	.068
Officer was Suspended	V104	6724	41.137	1	.000	.078
Officer's Supervisor was Disciplined	V105	6724	35.912	1	.000	.073
Officer's Chief is Under Scrutiny	V106	6724	7.628	1	.006	.034
Discussion of Agency Scandal / Cover Up	V107	6724	183.301	1	.000	.165
Citizen Complaint as Method of Detection	V108	6724	445.610	1	.000	.257
DUI-related Traffic Accident	V110	6724	171.858	1	.000	.160
Injuries in DUI-related Traffic Accident	V111	6724	74.117	1	.000	.105
DUI On-Duty in Police Vehicle	V112	6724	17.188	1	.000	.051
DUI in Take-Home Police Vehicle	V113	6724	25.730	1	.000	.062
DUI in Police Vehicle Out of Jurisdiction	V114	6724	9.653	1	.002	.038

DUI in Personally-owned Vehicle	V115	6724	206.189	1	.000	.175
DUI-Refused BAC Test	V117	6724	62.246	1	.000	.096
Off-Duty: 24-Hour Ordinance	V118	6724	11.218	1	.001	.041
Off-Duty: Identified Self as Police Officer	V119	6724	32.075	1	.000	.069
Off-Duty: Showed Police Weapon	V121	6724	26.293	1	.000	.063
Off-Duty: Conducted a Search	V123	6724	5.929	1	.015	.030
Family Violence	V126	6724	331.114	1	.000	.222
DUI: Officer Resisted Arrest	V127	6724	14.042	1	.000	.046
DUI: In Possession of a Firearm	V128	6724	28.911	1	.000	.066
Heroin	V129	6724	82.346	1	.000	.111
Hydrocodone	V131	6724	19.915	1	.000	.054
Oxycodone	V133	6724	36.133	1	.000	.073
Other Narcotics	V135	6724	12.698	1	.000	.043
Gamma Hydroxybutyric Acid	V136	6724	6.454	1	.011	.031
Cocaine	V139	6724	380.676	1	.000	.238
Crack	V140	6724	76.983	1	.000	.107
Amphetamine / Methamphetamine	V141	6724	57.944	1	.000	.093
MDMA & Analogs	V144	6724	27.585	1	.000	.064
Phencyclidine & Analogs	V146	6724	18.071	1	.000	.052
Marijuana	V148	6724	176.476	1	.000	.162
Testosterone	V151	6724	11.666	1	.001	.042
Other Anabolic Steroids	V152	6724	38.325	1	.000	.075
OIDV: Weapon: Dept-issued Gun	V156	6724	14.648	1	.000	.047
OIDV: Weapon: Personally-owned Gun	V157	6724	27.001	1	.000	.063
OIDV: Weapon: Knife	V163	6724	4.660	1	.031	.026
OIDV: Weapon: Hands / Fist	V164	6724	170.143	1	.000	.159
OIDV: Weapon: Other Body Parts	V165	6724	22.830	1	.000	.058
OIDV: Weapon: Miscellaneous Objects	V166	6724	20.619	1	.000	.055
OIDV: Verbal Threats / Violent Ultimatums	V167	6724	38.805	1	.000	.076
OIDV: Gun was Confiscated	V168	6724	37.870	1	.000	.075
OIDV: Confiscated Gun was Returned	V169	6724	5.906	1	.015	.030
OIDV: Article Mentions Gun Prohibition	V170	6724	16.243	1	.000	.049
OIDV: Order of Protection was Filed	V171	6724	38.163	1	.000	.075
OIDV: Officer Violated Order of Protection	V172	6724	11.218	1	.001	.041
OIDV: Victim Injured, Nonfatal	V173	6724	136.696	1	.000	.143
OIDV: Victim Injured, Fatal	V174	6724	9.653	1	.002	.038

42 U.S.C. 1985 Civil Defendant	V177	6724	14.891	1	.000	.047
42 U.S.C. 1997 Civil Defendant	V178	6724	18.490	1	.000	.052
18 U.S.C. 242 Criminal Defendant	V181	6724	10.720	1	.001	.040
Most Serious Offense Charged	V183	6724	4449.343	1	.000	.813
Drugs: Personal Use / Using	V196	6724	5.059	1	.025	.027
Drugs: Sexually-motivated Drug Crime	V199	6724	5.370	1	.020	.028
Drugs: Planting Evidence	V200	6724	14.244	1	.000	.046
Drugs: Falsification	V209	6724	25.507	1	.000	.062
Narcotics	Narcotics	6724	112.680	1	.000	.129
Stimulants	Stimul	6724	441.677	1	.000	.256
Hallucinogens	Hallucin	6724	44.397	1	.000	.081
Cannabis	Cannab	6724	176.476	1	.000	.162
Anabolic Steroids	Anabol	6724	43.764	1	.000	.081
DUI in a Police Vehicle	DUIinP	6724	44.963	1	.000	.082
Age Categorical	AgeCat	6724	31.473	10	.000	.068
Years of Service Categorical	YrsServC	6724	24.044	10	.007	.060
Metro or Nonmetro County	CountyDi	6724	9.943	1	.002	.038
Geographic Region	GeogReg	6724	27.852	3	.000	.064
Geographic Division	GeogDiv	6724	54.990	8	.000	.090
Rank by Function	RankFunc	6724	39.513	2	.000	.077
Victim Age Categorical	VicAgeCat	6724	637.177	9	.000	.308
Victim Age Difference	VicAgeDiff	6724	603.574	103	.000	.300

Table 17. Logistic Regression Model Predicting Profit-motivated Arrest Cases ($N = 1,330$)

	<i>B</i>	<i>SE</i>	Wald	<i>p</i>	Exp(B)	95% CI for Exp(B)	
						<i>LL</i>	<i>UL</i>
Duty Status (V6)	0.926	0.398	5.417	.020	2.525	1.158	5.510
Age of Victim (V83)	0.076	0.024	9.953	.002	1.079	1.029	1.131
Sex-related Crime (V95)	-2.340	0.655	12.784	<.001	0.096	0.027	0.347
Violence-related Crime (V96)	-2.808	0.435	41.592	<.001	0.060	0.026	0.142
Citizen Complaint as Method of Crime Detection (V108)	1.777	0.596	8.900	.003	5.911	1.840	18.997
42 USC § 1985 Civil Defendant at Some Point (V177)	1.662	0.784	4.496	.034	5.268	1.134	24.477
Victim Age Difference	0.046	0.022	4.557	.033	1.047	1.004	1.092
- 2 Log Likelihood	205.905						
Model Chi-Square	110.546			<.001			
Cox & Snell R^2	.080						
Nagelkerke R^2	.377					95% CI for AUC	
ROC R^2	.740					<i>LL</i>	<i>UL</i>
AUC	.870					.801	.939

Table 18. Chi-Square Predicting Being Named a Party-Defendant in 42 U.S.C. 1983 Litigation at Some Point

Variable Label	Variable	<i>N</i>	χ^2	<i>df</i>	<i>p</i>	<i>V</i>
Age	V3	5863	198.143	56	.000	.184
Years of Service	V4	4780	250.387	43	.000	.229
Gender	V5	6724	30.465	1	.000	.067
Duty Status	V6	6724	203.914	1	.000	.174
Rank	V7	6724	125.643	9	.000	.137
Type of Agency	V9	6724	30.828	7	.000	.068
Full-Time Sworn Personnel Categorical	V10	6724	60.276	10	.000	.095
State	V11	6724	346.944	50	.000	.227
Part-Times Sworn Personnel Categorical	V12	6724	25.560	8	.001	.062
Urban to Rural Continuum Code	V13	6724	75.487	8	.000	.106
Arresting Agency	V14	6724	4.414	1	.036	.026
Aggravated Assault	V16	6724	38.690	1	.000	.076
Bribery	V19	6724	9.418	1	.002	.037
Counterfeiting / Forgery	V21	6724	5.135	1	.023	.028
Property Destruction / Vandalism	V22	6724	5.593	1	.018	.029
Extortion / Blackmail	V26	6724	7.905	1	.005	.034
Credit Card / ATM Fraud	V28	6724	4.256	1	.039	.025
Murder & Nonnegligent Manslaughter	V36	6724	16.915	1	.000	.050
Kidnapping / Abduction	V39	6724	41.130	1	.000	.078
Pornography / Obscene Material	V49	6724	11.702	1	.001	.042
Robbery	V51	6724	19.811	1	.000	.054
Forcible Sodomy	V54	6724	20.992	1	.000	.056
Forcible Fondling	V56	6724	3.894	1	.048	.024
Incest	V57	6724	4.417	1	.036	.026
Online Solicitation of a Child	V60	6724	3.964	1	.046	.024
Weapons Law violation	V63	6724	3.964	1	.046	.024
Criminal Civil Rights Deprivation	V65	6724	97.041	1	.000	.120
Driving Under the Influence	V67	6724	55.349	1	.000	.091
Drunkenness	V68	6724	3.964	1	.046	.024
False Report / False Statement	V70	6724	23.451	1	.000	.059
Family Offenses, Nonviolent	V71	6724	5.824	1	.016	.029
Liquor Law violation	V73	6724	7.133	1	.008	.033
Obstruction of Justice	V74	6724	27.533	1	.000	.064
Official Misconduct	V75	6724	50.495	1	.000	.087

Gender of Victim	V81	3668	23.663	1	.000	.080
Age of Victim	V83	1848	159.139	79	.000	.293
Child Victim	V84	3990	31.977	1	.000	.090
Victim Relationship to Offender	V85	3934	111.173	7	.000	.168
Organizational vs. Against Citizenry	V90	6724	4.806	1	.028	.027
Internal vs. Organizational	V91	6724	68.775	1	.000	.101
Official Capacity	V92	6724	226.119	1	.000	.183
Drug-related	V93	6724	25.553	1	.000	.062
Alcohol-related	V94	6724	42.196	1	.000	.079
Sex-related	V95	6724	6.121	1	.013	.030
Violence-related	V96	6724	103.675	1	.000	.124
Police Sexual Violence	V98	6724	94.879	1	.000	.119
Driving While Female Encounter	V99	6724	85.219	1	.000	.113
Officer was Reassigned	V102	6724	13.877	1	.000	.045
Officer was Demoted in Rank	V103	6724	4.697	1	.030	.026
Officer's Supervisor was Disciplined	V105	6724	127.576	1	.000	.138
Officer's Chief is Under Scrutiny	V106	6724	162.480	1	.000	.155
Discussion of Agency Scandal / Cover Up	V107	6724	180.093	1	.000	.164
Citizen Complaint as Method of Detection	V108	6724	14.587	1	.000	.047
DUI-related Traffic Accident	V110	6724	39.181	1	.000	.076
Injuries in a DUI-related Traffic Accident	V111	6724	13.982	1	.000	.046
DUI in Personally-owned Vehicle	V115	6724	31.774	1	.000	.069
DUI: Refused Field Sobriety Tests	V116	6724	4.836	1	.028	.027
DUI: Refused BAC Test	V117	6724	10.132	1	.001	.039
Off-Duty: Identified Self as a Police Officer	V119	6724	4.289	1	.038	.025
Off-Duty: Showed Police Weapon	V121	6724	4.264	1	.039	.025
Off-Duty: Conducted a Search	V123	6724	16.089	1	.000	.049
Off-Duty: Made an Arrest	V124	6724	6.484	1	.011	.031
Family Violence	V126	6724	16.650	1	.000	.050
DUI: Officer Resisted Arrest	V127	6724	4.097	1	.043	.025
Oxycodone	V133	6724	6.647	1	.010	.031
Cocaine	V139	6724	29.094	1	.000	.066
Crack	V140	6724	6.285	1	.012	.031
Marijuana	V148	6724	8.800	1	.003	.036
OIDV: Weapon: Hands / Fist	V164	6724	9.072	1	.003	.037
OIDV: Verbal Threats / Violent Ultimatums	V167	6724	9.421	1	.002	.037

OIDV: Victim Injury, Nonfatal	V173	6724	8.627	1	.003	.036
42 U.S.C. 1981 Civil Defendant	V175	6724	435.624	1	.000	.255
42 U.S.C. 1985 Civil Defendant	V177	6724	632.692	1	.000	.307
42 U.S.C. 1997 Civil Defendant	V178	6724	1247.262	1	.000	.431
28 U.S.C. 1441 Civil Rights Action Removed	V179	6724	1192.487	1	.000	.421
18 U.S.C. 242 Criminal Defendant	V181	6724	171.608	1	.000	.160
Most Serious Offense Charged	V183	6724	320.050	63	.000	.218
Drugs: Personal Use / Using	V196	6724	6.408	1	.011	.031
Drugs: Planting Evidence	V200	6724	38.120	1	.000	.075
Drugs: Facilitating Drug Trade	V201	6724	3.833	1	.050	.024
Drugs: Shakedown from Street Dealers	V202	6724	118.716	1	.000	.133
Drugs: Shakedown from Warrantless Search	V204	6724	95.587	1	.000	.119
Drugs: Shakedown from Legit Search/Raid	V205	6724	28.690	1	.000	.065
Drugs: Shakedown from Car Stops	V206	6724	75.474	1	.000	.106
Drugs: Falsification	V209	6724	31.330	1	.000	.068
Drugs: Shakedown - Aggregate	V210	6724	99.877	1	.000	.122
Drugs: Stimulants	Stimul	6724	21.921	1	.000	.057
Drugs: Cannabis	Cannab	6724	8.800	1	.003	.036
Age Categorical	AgeCat	6724	108.469	10	.000	.127
Years of Service Categorical	YrsServC	6724	155.578	10	.000	.152
Metro or NonMetro County	CountyD	6724	15.672	1	.000	.048
Geographic Region	GeogReg	6724	65.296	3	.000	.099
Geographic Division	GeogDiv	6724	123.337	8	.000	.135
Rank by Function	RankFunc	6724	55.134	2	.000	.091
Victim Age Categorical	VictimAg	6724	90.534	9	.000	.116
Victim Age Difference	VicAgeDi	6724	157.015	103	.000	.153

Table 19. Logistic Regression Model Predicting Being Named a 42 USC §1983 Party-Defendant at Some Point ($N = 1,278$)

	<i>B</i>	<i>SE</i>	Wald	<i>p</i>	Exp(B)	95% CI for Exp(B)	
						<i>LL</i>	<i>UL</i>
Years of Service (V4)	0.067	0.010	43.606	<.001	1.069	1.048	1.091
Duty Status (V6)	1.086	0.187	33.762	<.001	2.962	2.054	4.273
Full-Time Sworn Personnel Categorical (V10)	0.071	0.030	5.498	.019	1.073	1.012	1.139
Murder & Nonnegligent Manslaughter (V36)	0.692	0.282	6.011	.014	1.998	1.149	3.475
Kidnapping/Abduction (V39)	0.753	0.272	7.669	.006	2.123	1.246	3.617
Victim Relationship to Offender (V85)	0.175	0.065	7.308	.007	1.191	1.049	1.352
Driving While Female Encounter (V99)	0.934	0.346	7.285	.007	2.544	1.291	5.011
Officer was Assigned to Another Position (V102)	0.854	0.334	6.544	.011	2.349	1.221	4.518
Officer's Supervisor was Disciplined / Reassigned (V105)	2.369	0.488	23.592	<.001	10.686	4.108	27.796
DUI in a Privately-owned Vehicle (V115)	-1.348	0.465	8.421	.004	0.260	0.104	0.645
Off-Duty: Identified Self as an Officer (V119)	1.060	0.301	12.374	<.001	2.885	1.599	5.208
Family Violence (V126)	0.737	0.285	6.688	.010	2.090	1.195	3.653
Cocaine (V139)	2.007	0.747	7.227	.007	7.440	1.722	32.140
42 USC §1981 Civil Defendant at Some Point (V175)	3.962	0.718	30.421	<.001	52.584	12.863	214.965
18 USC §242 Criminal Defendant at Some Point (V181)	1.837	0.639	8.264	.004	6.276	1.794	21.956
Most Serious Offense Charged (V183)	-0.019	0.004	23.805	<.001	0.981	0.974	0.989
- 2 Log Likelihood	1177.989						
Model Chi-Square	328.366			<.001			
Cox & Snell R^2	.227						
Nagelkerke R^2	.327						
ROC R^2	.486						
AUC	.743						
						95% CI for AUC	
						<i>LL</i>	<i>UL</i>
						.723	.764

Table 20. Sex-related Police Crime Arrest Cases, 2005-2011: Arrested Officers and Employing Agencies (*N* = 1,475)

	<i>n</i>	(%)		<i>n</i>	(%)		<i>n</i>	(%)
Sex			Officer Duty Status			Agency Type		
Male	1,467	(99.5)	On-Duty	682	(46.2)	Primary State Police	61	(4.1)
Female	8	(0.5)	Off-Duty	793	(53.8)	Sheriff's Office	280	(19.0)
Age			Rank			County Police Dept.	30	(2.0)
19-23	26	(1.8)	Officer	1,168	(79.2)	Municipal Police Dept.	1,040	(70.5)
24-27	133	(9.0)	Detective	53	(3.6)	Special Police Dept.	56	(3.8)
28-31	208	(14.1)	Corporal	31	(2.0)	Constable	4	(0.3)
32-35	221	(15.0)	Sergeant	110	(7.5)	Tribal Police Dept.	3	(0.2)
36-39	261	(17.6)	Lieutenant	37	(2.5)	Regional Police Dept.	1	(0.1)
40-43	201	(13.6)	Captain	9	(0.6)	Full-Time Sworn Officers		
44-47	163	(11.1)	Major	1	(0.1)	0	20	(1.3)
48-51	87	(5.9)	Colonel	0	(0.0)	1	12	(0.8)
52-55	49	(3.3)	Deputy Chief	7	(0.5)	2-4	85	(5.8)
56 or older	48	(3.3)	Chief	59	(4.0)	5-9	112	(7.6)
Missing	78	(5.3)	Function			10-24	145	(9.8)
Years of Service			Patrol & Street Level	1,221	(82.8)	25-49	165	(11.2)
0-2	204	(13.8)	Line/Field Supervisor	178	(12.1)	50-99	140	(9.5)
3-5	246	(16.7)	Management	76	(5.1)	100-249	178	(12.1)
6-8	163	(11.0)	Region of United States			250-499	144	(9.8)
9-11	168	(11.4)	Northeastern States	259	(17.6)	500-999	125	(8.5)
12-14	119	(8.1)	Midwestern States	242	(16.4)	1,000 or more	349	(23.6)
15-17	84	(5.7)	Southern States	658	(44.6)	Part-Time Sworn Officers		
18-20	91	(6.1)	Western States	316	(21.4)	0	1,031	(69.9)
21-23	38	(2.6)	Level of Rurality			1	64	(4.3)
24-26	44	(3.0)	Metropolitan County	1,229	(83.3)	2-4	162	(11.0)
27 or more years	38	(2.6)	Non-Metro County	246	(16.7)	5-9	99	(6.7)
Missing	280	(19.0)	Arresting Agency			10-24	77	(5.2)
Employing Agency	556	(37.7)	Employing Agency			25-49	28	(1.9)
Another Agency	919	(62.3)	Another Agency			50-99	10	(0.7)
						100-249	4	(0.3)
						250-499	0	(0.0)

Table 21. Most Serious Offense Charged in Sex-related Police Crime Arrest Cases, 2005-2011 (*N* = 1,475)

	<i>n</i>	(%)		<i>n</i>	(%)
Forcible Fondling	352	(23.9)	Burglary / Breaking & Entering	7	(0.5)
Forcible Rape	322	(21.8)	Disorderly Conduct	7	(0.5)
Statutory Rape	100	(6.8)	Arson	6	(0.4)
Unclassified Sex Crime	98	(6.6)	Unclassified Theft / Larceny	6	(0.4)
Forcible Sodomy	94	(6.4)	Drug / Narcotic violation	4	(0.3)
Pornography / Obscene Material	86	(5.8)	Incest	4	(0.3)
Intimidation	52	(3.5)	False Report / False Statement	4	(0.3)
Online Solicitation of a Child	44	(3.0)	Destroying / Tampering Evidence	3	(0.2)
Prostitution	42	(2.8)	Obstruction of Justice	3	(0.2)
Simple Assault	37	(2.5)	False Pretenses / Swindle	2	(0.1)
Indecent Exposure	37	(2.5)	Wire Fraud	2	(0.1)
Official Misconduct / Oppression	35	(2.4)	Murder / Nonnegligent Manslaughter	2	(0.1)
Aggravated Assault	25	(1.7)	Theft from Building	2	(0.1)
Bribery	19	(1.3)	Robbery	2	(0.1)
Kidnapping / Abduction	13	(0.9)	Liquor Law violation	2	(0.1)
Criminal Deprivation of Civil Rights	13	(0.9)	Peeping Tom	2	(0.1)
Extortion / Blackmail	12	(0.8)	Credit Card / ATM Fraud	1	(0.1)
Assisting or Promoting Prostitution	12	(0.8)	Stolen Property Offenses	1	(0.1)
Sexual Assault with an Object	10	(0.7)	Weapons Law violation	1	(0.1)
Other / Unclassified Offenses	10	(0.7)	Restraining Order / Protection Order violation	1	(0.1)

Table 22. Victim Characteristics in Sex-related Police Crime Arrest Cases, 2005-2011 (*N* = 1,475)

	<i>n</i>	(%)	(Valid %)		<i>n</i>	(%)	(Valid %)
Victim's Sex				Victim's Relationship			
Female	1,160	(78.6)	(89.0)	Current Spouse	10	(0.7)	(0.7)
Male	143	(9.7)	(11.0)	Former Spouse	5	(0.4)	(0.4)
Missing	172	(11.7)		Current Girlfriend or Boyfriend	15	(1.0)	(1.1)
Victim's Age				Former Girlfriend or Boyfriend	12	(0.8)	(0.9)
Birth-11	108	(7.3)	(13.3)	Child or Stepchild	59	(4.0)	(4.4)
12-13	118	(8.0)	(14.5)	Some Other Relative	55	(3.7)	(4.1)
14-15	202	(13.7)	(24.8)	Unrelated Child	527	(35.7)	(39.3)
16-17	139	(9.4)	(17.1)	Stranger or Acquaintance	658	(44.6)	(49.1)
18-19	54	(3.7)	(6.6)	Missing	134	(9.1)	
20-24	73	(4.9)	(8.9)	Victim's Law Enforcement Status			
25-32	64	(4.3)	(7.9)	Victim is Not a Police Officer	1,320	(89.5)	(98.2)
33-41	42	(2.8)	(5.2)	Victim is a Police Officer	24	(1.6)	(1.8)
42 or older	14	(0.9)	(1.7)	Missing	131	(8.9)	
Missing	661	(44.8)		Victim Adult or Child			
				Adult	721	(48.9)	(52.4)
				Child	656	(44.5)	(47.6)
				Missing	98	(6.6)	

Table 23. Bivariate Associations of Conviction in Sex-related Arrest Cases

Variable Label	Variable	<i>N</i>	χ^2	<i>df</i>	<i>p</i>	<i>V</i>
Year of Arrest	V2	986	22.294	6	.001	.150
Years of Service	V4	820	52.020	34	.025	.252
Gender	V5	986	4.061	1	.044	.064
Duty Status	V6	986	7.117	1	.008	.085
Rank	V7	986	23.227	8	.003	.153
Full-Time Sworn Personnel (categorical)	V10	986	19.604	10	.033	.141
State	V11	986	80.347	48	.002	.285
Part-Time Sworn Personnel (categorical)	V12	986	16.568	7	.020	.130
Urban / Rural Continuum	V13	986	16.956	8	.031	.131
Pornography	V49	986	11.451	1	.001	.108
Forcible Sodomy	V54	986	4.401	1	.036	.067
Indecent Exposure	V59	986	3.816	1	.051	.062
Drunkness	V68	986	4.061	1	.044	.064
Age of Victim	V83	541	86.980	50	.001	.401
Child Victim	V84	920	25.110	1	.000	.165
Victim's Relationship to the Offender	V85	905	36.740	7	.000	.201
28 U.S.C. §1441 Civil Case Removed	V179	986	4.365	1	.037	.067
18 U.S.C. §242 Criminal Defendant	V181	986	10.527	1	.001	.103
Job Lost	joblostbin	986	36.614	1	.000	.193
Geographic Region	geogreg	986	10.588	3	.014	.104
Geographic Division	geogdiv	986	19.175	8	.014	.139
Rank Function	rankfunc	986	10.143	2	.006	.101
Victim Age Categorical	vicagecat	986	21.231	9	.012	.147

Table 24. Sex-related Arrest Cases: Logistic Regression Model Predicting Conviction ($N = 447$)

	<i>B</i>	<i>SE</i>	Wald	<i>p</i>	Exp(B)	95% CI for Exp(B)	
						<i>LL</i>	<i>UL</i>
Years of Service	0.056	0.021	7.353	.007	1.058	1.016	1.102
Pornography / Obscene Material	1.737	0.769	5.107	.024	5.678	1.259	25.608
Child Victim	0.728	0.279	6.832	.009	2.071	1.200	3.575
Lost Job	1.661	0.293	32.044	< .001	5.266	2.963	9.360
- 2 Log Likelihood	354.228						
Model Chi-Square	50.179			<.001			
Cox & Snell R^2	.106						
Nagelkerke R^2	.178						
ROC R^2	.346						
AUC	.673					95% CI for AUC	
						<i>LL</i>	<i>UL</i>
						.621	.725

Table 25. Bivariate Associations of Job Loss in Sex-related Police Crime Arrest Cases

Variable Label	Variable	<i>N</i>	χ^2	<i>df</i>	<i>p</i>	<i>V</i>
Year of Arrest	V2	1,475	135.487	6	.000	.303
Age	V3	1,397	68.062	46	.019	.221
Years of Service	V4	1,195	62.775	36	.004	.229
Gender	V5	1,475	20.753	1	.000	.119
Duty Status	V6	1,475	5.692	1	.017	.062
Type of Agency	V9	1,475	15.908	7	.026	.104
Full-Time Sworn Personnel (categorical)	V10	1,475	41.867	10	.000	.168
State	V11	1,475	111.725	48	.000	.275
Part-Time Sworn Personnel (categorical)	V12	1,475	39.503	7	.000	.164
Urban / Rural Continuum	V13	1,475	20.333	8	.009	.117
Arresting Agency	V14	1,475	5.911	1	.015	.063
Bribery	V19	1,475	13.207	1	.000	.095
Kidnapping / Abduction	V39	1,475	5.104	1	.024	.059
Prostitution	V50	1,475	9.096	1	.003	.079
Forcible Fondling	V56	1,475	6.148	1	.013	.065
Incest	V57	1,475	5.991	1	.014	.064
Indecent Exposure	V59	1,475	7.600	1	.006	.072
Unclassified Sex Crime	V61	1,475	8.111	1	.004	.074
Criminal Deprivation of Civil Rights	V65	1,475	4.892	1	.027	.058
Internal Crime Against the Organization	V91	1,475	34.420	2	.000	.153
Official Capacity	V92	1,475	7.595	1	.006	.072
Violence-related	V96	1,475	6.956	1	.008	.069
Police Sexual Violence	V98	1,475	4.849	1	.028	.057
Driving While Female Encounter	V99	1,475	15.105	1	.000	.101
Suspended	V104	1,475	42.412	1	.000	.170
Crime Detected by Citizen Complaint	V108	1,475	9.246	1	.002	.079
Conviction	V109	986	36.614	1	.000	.193
Off-Duty: In Uniform	V120	1,475	5.478	1	.019	.061
Marijuana	V148	1,475	4.857	1	.028	.057
42 U.S.C. §1983 Civil Defendant	V176	1,475	9.706	1	.002	.081
42 U.S.C. §1985 Civil Defendant	V177	1,475	6.845	1	.009	.068
28 U.S.C. §1441 Civil Case Removed	V179	1,475	5.434	1	.020	.061
18 U.S.C. §242 Criminal Defendant	V181	1,475	7.627	1	.006	.072
Geographic Region	geogreg	1,475	21.667	3	.000	.121
Geographic Division	geogdiv	1,475	27.896	8	.000	.138

Table 26. Sex-related Arrest Cases: Logistic Regression Model Predicting Job Loss ($N = 801$)

	<i>B</i>	<i>SE</i>	Wald	<i>p</i>	Exp(B)	95% CI for Exp(B)	
						<i>LL</i>	<i>UL</i>
Year of Arrest	0.339	0.061	31.037	< .001	1.404	1.246	1.582
Age	-0.036	0.012	8.489	.004	0.965	0.942	0.988
Internal Crime Against the Organization	0.121	0.045	7.167	.007	1.129	1.033	1.234
Official Capacity	0.890	0.282	9.973	.002	2.435	1.402	4.231
Driving While Female Encounter	0.999	0.455	4.825	.028	2.715	1.114	6.620
Suspended	-0.942	0.255	13.651	< .001	0.390	0.236	0.642
Conviction	1.341	0.237	31.918	< .001	3.824	2.401	6.089
Marijuana	-1.929	0.693	7.740	.005	0.145	0.037	0.566
42 U.S.C. §1983 Civil Defendant at Some Point	0.798	0.254	9.879	.002	2.221	1.350	3.653
- 2 Log Likelihood	625.507						
Model Chi-Square	141.128			<.001			
Cox & Snell R^2	.162						
Nagelkerke R^2	.262						
ROC R^2	.544						
AUC	.772						
						95% CI for AUC	
						<i>LL</i>	<i>UL</i>
						.733	.810

Table 27. Bivariate Associations of Child Victims in Sex-related Arrest Cases

Variable Label	Variable	<i>N</i>	χ^2	<i>df</i>	<i>p</i>	<i>V</i>
Age	V3	1,311	125.721	46	.000	.310
Years of Service	V4	1,120	92.784	35	.000	.288
Duty Status	V6	1,377	323.355	1	.000	.485
Full-Time Sworn Personnel (categorical)	V10	1,377	65.462	10	.000	.218
State	V11	1,377	121.063	48	.000	.297
Urban to Rural Continuum	V13	1,377	48.962	8	.000	.189
Arresting Agency	V14	1,377	44.190	1	.000	.179
Aggravated Assault	V16	1,377	30.395	1	.000	.149
Simple Assault	V17	1,377	24.392	1	.000	.133
Intimidation	V18	1,377	41.325	1	.000	.173
Bribery	V19	1,377	46.090	1	.000	.183
Burglary	V20	1,377	20.342	1	.000	.122
Extortion	V26	1,377	11.053	1	.001	.090
Kidnapping / Abduction	V39	1,377	86.974	1	.000	.251
Unclassified Theft / Larceny	V47	1,377	3.983	1	.046	.054
Pornography	V49	1,377	99.843	1	.000	.269
Prostitution	V50	1,377	21.057	1	.000	.124
Forcible Rape	V53	1,377	25.396	1	.000	.136
Forcible Fondling	V56	1,377	37.176	1	.000	.164
Incest	V57	1,377	10.497	1	.001	.087
Statutory Rape	V58	1,377	179.498	1	.000	.361
Indecent Exposure	V59	1,377	13.792	1	.000	.100
On-Line Solicitation of a Child	V60	1,377	61.773	1	.000	.212
Unclassified Sex Crime	V61	1,377	14.145	1	.000	.101
Weapons Law violation	V63	1,377	7.014	1	.008	.071
Criminal Deprivation of Civil Rights	V65	1,377	27.903	1	.000	.142
Disorderly Conduct	V66	1,377	6.308	1	.012	.068
False Report / False Statement	V70	1,377	6.207	1	.013	.067
Obstruction of Justice	V74	1,377	5.408	1	.020	.063
Official Misconduct / Oppression	V75	1,377	161.527	1	.000	.342
Unclassified Offenses	V80	1,377	23.373	1	.000	.130
Gender of Victim	V81	1,296	51.951	1	.000	.200
Internal Crime Against the Organization	V91	1,377	72.810	2	.000	.230
Official Capacity	V92	1,377	330.080	1	.000	.490

Violence-related	V96	1,377	57.564	1	.000	.204
Profit-motivated	V97	1,377	9.394	1	.002	.083
Police Sexual Violence	V98	1,377	290.300	1	.000	.459
Driving While Female Encounter	V99	1,377	142.850	1	.000	.322
Discussion of Agency Scandal or Cover Up	V107	1,377	5.352	1	.021	.062
Method of Crime Detection	V108	1,377	28.531	1	.000	.144
Conviction	V109	920	25.110	1	.000	.165
Off-Duty: In Uniform	V120	1,377	6.308	1	.012	.068
Off-Duty: Showed Police Weapon	V121	1,377	13.870	1	.000	.100
Family Violence	V126	1,377	20.034	1	.000	.121
OIDV: Weapon: Personally Owned Gun	V157	1,377	4.566	1	.033	.058
OIDV: Weapon: Hands / Fists	V164	1,377	4.361	1	.037	.056
OIDV: Verbal Threats / Violent Ultimatums	V167	1,377	6.308	1	.012	.068
OIDV: Victim Injured, nonfatal	V173	1,377	6.194	1	.013	.067
42 U.S.C. §1983 Civil Defendant Some Point	V176	1,377	60.897	1	.000	.210
28 U.S.C. §1441 Civil Case Removed	V179	1,377	12.257	1	.000	.094
18 U.S.C. §242 Criminal Defendant	V181	1,377	11.053	1	.001	.090
Age Categorical	agecat	1,377	50.515	10	.000	.192
Years of Service Categorical	yrsservcat	1,377	31.988	10	.000	.152
Geographic Division	geogdiv	1,377	36.261	8	.000	.162

Table 28. Sex-related Arrest Cases: Logistic Regression Model Predicting Child Victims ($N = 722$)

	<i>B</i>	<i>SE</i>	Wald	<i>p</i>	Exp(B)	95% CI for Exp(B)	
						<i>LL</i>	<i>UL</i>
Duty Status	-1.798	0.315	32.509	< .001	0.166	0.089	0.307
Full-Time Sworn Personnel (categorical)	-0.195	0.054	13.134	< .001	0.823	0.741	0.915
Urban to Rural Continuum Code	-0.194	0.087	5.004	.025	0.824	0.695	0.976
Aggravated Assault	-2.688	0.771	12.155	< .001	0.068	0.015	0.308
Intimidation	-1.556	0.561	7.692	.006	0.211	0.070	0.634
Kidnapping / Abduction	-1.390	0.455	9.322	.002	0.249	0.102	0.608
Pornography / Obscene Material	1.357	0.652	4.336	.037	3.885	1.083	13.936
Forcible Fondling	1.245	0.259	23.100	< .001	3.474	2.091	5.774
Indecent Exposure	-1.357	0.517	6.880	.009	0.257	0.093	0.710
Unclassified Sex Crime	1.434	0.353	16.479	< .001	4.195	2.099	8.382
Weapons Law violation	-3.054	1.125	7.367	.007	0.047	0.005	0.428
Obstruction of Justice	-3.822	1.191	10.289	.001	0.022	0.002	0.226
Gender of Victim	1.816	0.452	16.148	< .001	6.144	2.535	14.896
Violence-related	-1.658	0.402	17.046	< .001	0.191	0.087	0.419
Police Sexual Violence	-0.986	0.312	10.008	.002	0.373	0.202	0.687
Driving While Female Encounter	-1.744	0.578	9.115	.003	0.175	0.056	0.542
Discussion of Agency Scandal or Cover Up	1.861	0.577	10.412	.001	6.427	2.076	19.900
Conviction	0.799	0.285	7.869	.005	2.223	1.272	3.883
Family Violence	0.941	0.399	5.557	.018	2.563	1.172	5.606
Geographic Division	0.101	0.047	4.596	.032	1.106	1.009	1.212
- 2 Log Likelihood	492.641						
Model Chi-Square	505.330			<.001			
Cox & Snell R^2	.503						
Nagelkerke R^2	.672						
ROC R^2	.840						
AUC	.920					95% CI for AUC	
						<i>LL</i>	<i>UL</i>
						.902	.938

Table 29. Bivariate Associations of Conviction in Police Sexual Violence Arrest Cases

Variable Label	Variable	<i>N</i>	χ^2	<i>df</i>	<i>p</i>	<i>V</i>
Year of Arrest	V2	431	18.185	6	.006	.205
Urban to Rural Continuum	V13	431	20.573	8	.008	.008
False Pretenses / Swindle	V27	431	4.021	1	.045	.097
Forcible Sodomy	V54	431	6.671	1	.010	.124
Forcible Fondling	V56	431	6.754	1	.009	.125
Statutory Rape	V58	431	3.966	1	.046	.096
Victim is a Police Officer	V82	430	4.112	1	.043	.098
Victim is a Child	V84	427	9.742	1	.002	.151
Victim's Relationship	V85	427	20.988	6	.002	.222
Violence-related	V96	431	4.955	1	.026	.107
Drugs: Personal Use / Using	V196	431	4.021	1	.045	.097
Job Lost Binary	joblostbin	431	22.139	1	.000	.227
Geographic Division	geogdiv	431	15.821	8	.045	.192

Table 30. Police Sexual Violence Arrest Cases: Logistic Regression Model Predicting Conviction ($N = 427$)

	<i>B</i>	<i>SE</i>	Wald	<i>p</i>	Exp(B)	95% CI for Exp(B)	
						<i>LL</i>	<i>UL</i>
Forcible Sodomy	1.146	0.495	5.368	.021	3.146	1.193	8.297
Forcible Fondling	-0.779	0.260	8.965	.003	0.459	0.276	0.764
Child Victim	1.321	0.389	11.529	.001	3.748	1.748	8.037
Lost Job	1.329	0.325	16.750	< .001	3.778	1.999	7.140
- 2 Log Likelihood	381.630						
Model Chi-Square	44.602			<.001			
Cox & Snell R^2	.099						
Nagelkerke R^2	.157						
ROC R^2	.422						
AUC	.711					95% CI for AUC	
						<i>LL</i>	<i>UL</i>
						.647	.774

Table 31. Bivariate Associations of Job Loss in Police Sexual Violence Arrest Cases

Variable Label	Variable	<i>N</i>	χ^2	<i>df</i>	<i>p</i>	<i>V</i>
Year of Arrest	V2	622	60.900	6	.000	.313
Years of Service	V4	495	61.583	29	.000	.353
Gender	V5	622	18.253	1	.000	.171
Type of Agency	V9	622	17.772	6	.007	.169
Full-Time Sworn (categorical)	V10	622	18.829	10	.042	.174
State	V11	622	78.683	45	.001	.356
Part-Time Sworn (categorical)	V12	622	17.903	7	.012	.170
Simple Assault	V17	622	4.288	1	.038	.083
Intimidation	V18	622	7.658	1	.006	.111
Bribery	V19	622	9.214	1	.002	.122
Burglary	V20	622	5.451	1	.020	.094
Kidnapping / Abduction	V39	622	6.004	1	.014	.098
Indecent Exposure	V59	622	3.742	1	.053	.078
Other / Unclassified Sex Crime	V61	622	6.219	1	.013	.100
Weapons Law violation	V63	622	6.685	1	.010	.104
Official Misconduct / Oppression	V75	622	7.616	1	.006	.111
All Other Offenses / Unclassified	V80	622	5.706	1	.017	.096
Internal Crime Against the Organization	V91	622	52.301	1	.000	.290
Alcohol-related	V94	622	4.667	1	.031	.087
Driving While Female Encounter	V99	622	12.156	1	.000	.140
Suspended	V104	622	23.630	1	.000	.195
Officer's Supervisor was Disciplined	V105	622	3.776	1	.052	.078
Conviction	V109	431	22.139	1	.000	.227
Years of Service Categorical	yrsservcat	622	25.372	10	.005	.202
Geographic Region	geogreg	622	12.336	3	.006	.141
Geographic Division	geogdiv	622	17.510	8	.025	.168
Rank by Function	rankfunc	622	8.663	2	.013	.118
Victim Age Categorical	vicagecat	622	22.063	9	.009	.188

Table 32. Police Sexual Violence Arrest Cases: Logistic Regression Model Predicting Job Loss ($N = 354$)

	<i>B</i>	<i>SE</i>	Wald	<i>p</i>	Exp(B)	95% CI for Exp(B)	
						<i>LL</i>	<i>UL</i>
Part-Time Sworn Personnel (categorical)	0.639	0.217	8.682	.003	1.894	1.238	2.896
Weapons Law violation	-2.504	1.137	4.846	.028	0.082	0.009	0.760
Internal Crime Against the Organization	0.260	0.051	25.790	< .001	1.297	1.173	1.433
Driving While Female Encounter	1.178	0.494	5.681	.017	3.249	1.233	8.560
Conviction	1.741	0.434	16.068	< .001	5.705	2.435	13.366
Years of Service (categorical)	-0.262	0.083	9.904	.002	0.770	0.654	0.906
- 2 Log Likelihood	201.017						
Model Chi-Square	64.762			<.001			
Cox & Snell R^2	.167						
Nagelkerke R^2	.317						
ROC R^2	.470						
AUC	.735					95% CI for AUC	
						<i>LL</i>	<i>UL</i>
						.651	.819

Table 33. Bivariate Associations of Conviction in Driving While Female Police Crime Arrest Cases

Variable Label	Variable	<i>N</i>	χ^2	<i>df</i>	<i>p</i>	<i>V</i>
Year of Arrest	V2	126	14.407	6	.025	.338
Full-Time Sworn Personnel (categorical)	V10	126	22.232	9	.008	.420
Burglary	V20	126	9.101	1	.003	.269
Drug / Narcotic violation	V23	126	4.514	1	.034	.189
Unclassified Theft / Larceny	V47	126	4.827	1	.028	.196
Sexual Assault with an Object	V55	126	6.081	1	.014	.220
Forcible Fondling	V56	126	5.277	1	.022	.205
Economically-motivated	V88	126	4.514	1	.034	.189
Against the Citizenry	V90	126	4.514	1	.034	.189
Internal Crime Against the Organization	V91	126	7.204	1	.007	.239
Alcohol-related	V94	126	9.895	1	.002	.280
Cocaine	V139	126	4.514	1	.034	.189
42 U.S.C. §1983	V176	126	3.728	1	.054	.172
Drugs: Using / Personal Use	V196	126	4.514	1	.034	.189
Job Loss (binary)	joblossbin	126	3.967	1	.046	.177
Stimulant	stimulant	126	4.514	1	.034	.189
Age Categorical	agecat	126	18.588	8	.017	.384
Rank Function	rankfunc	126	5.769	1	.016	.214

Table 34. Driving While Female Encounters Arrest Cases: Logistic Regression Model Predicting Conviction ($N = 126$)

	<i>B</i>	<i>SE</i>	Wald	<i>p</i>	Exp(B)	95% CI for Exp(B)	
						<i>LL</i>	<i>UL</i>
Sexual Assault with an Object	-2.050	1.029	3.969	.046	0.129	0.017	0.967
Forcible Fondling	-1.324	0.557	5.659	.017	0.266	0.089	0.792
Internal Crime Against the Organization	0.207	0.072	8.337	.004	1.230	1.069	1.416
Alcohol-related	-2.705	0.993	7.416	.006	0.067	0.010	0.468
42 U.S.C. §1983 Civil Defendant at Some Point	1.438	0.579	6.167	.013	4.214	1.354	13.113
- 2 Log Likelihood	88.550						
Model Chi-Square	31.206			<.001			
Cox & Snell R^2	.219						
Nagelkerke R^2	.358						
ROC R^2	.662						
AUC	.831						
						95% CI for AUC	
						<i>LL</i>	<i>UL</i>
						.741	.921

Table 35. Bivariate Associations of Job Loss in Driving While Female Arrest Cases

Variable Label	Variable	<i>N</i>	χ^2	<i>df</i>	<i>p</i>	<i>V</i>
Year of Arrest	V2	174	15.536	6	.016	.299
Age	V3	168	47.043	33	.054	.529
Years of Service	V4	144	42.173	22	.006	.541
Rank	V7	174	14.145	4	.007	.285
State	V11	174	53.896	33	.012	.557
Bribery	V19	174	6.714	1	.010	.196
Kidnapping / Abduction	V39	174	4.631	1	.031	.163
Forcible Rape	V53	174	4.293	1	.038	.157
Indecent Exposure	V59	174	12.402	1	.000	.267
Other / Unclassified Sex Crime	V61	174	5.870	1	.015	.184
Official Misconduct / Oppression	V75	174	5.792	1	.016	.182
Organizational versus Against Citizenry	V90	174	5.476	1	.019	.177
Internal versus Organizational	V91	174	13.514	1	.000	.279
Suspended	V104	174	4.094	1	.043	.153
Conviction	V109	126	3.967	1	.046	.177
Off-Duty: Identified Self as an Officer	V119	174	5.476	1	.019	.177
Victim Age Categorical	vicagecat	174	22.217	7	.002	.357
Victim Age Difference	vicagediff	174	51.795	28	.004	.546

Table 36. Driving While Female Encounters Arrest Cases: Logistic Regression Model Predicting Job Loss ($N = 105$)

	<i>B</i>	<i>SE</i>	Wald	<i>p</i>	Exp(B)	95% CI for Exp(B)	
						<i>LL</i>	<i>UL</i>
Internal Crime Against the Organization	0.357	0.141	6.441	.011	1.429	1.085	1.883
Victim Age Difference	-0.072	0.031	5.258	.022	0.931	0.875	0.990
- 2 Log Likelihood	41.223						
Model Chi-Square	15.344			<.001			
Cox & Snell R^2	.136						
Nagelkerke R^2	.326						
ROC R^2	.532						
AUC	.766					95% CI for AUC	
						<i>LL</i>	<i>UL</i>
						.671	.860

Table 37. Alcohol-related Police Crime Arrest Cases, 2005-2011: Arrested Officers and Employing Agencies (N = 1,405)

	<i>n</i>	(%)		<i>n</i>	(%)		<i>n</i>	(%)
Sex			Officer Duty Status			Agency Type		
Male	1,314	(93.5)	On-Duty	170	(12.1)	Primary State Police	74	(5.3)
Female	91	(6.5)	Off-Duty	1,235	(87.9)	Sheriff's Office	214	(15.2)
Age			Rank			County Police Dept.	54	(3.8)
19-23	41	(2.9)	Officer	1,051	(74.8)	Municipal Police Dept.	1,028	(73.2)
24-27	152	(10.8)	Detective	87	(6.2)	Special Police Dept.	24	(1.7)
28-31	175	(12.5)	Corporal	23	(1.6)	Constable	3	(0.2)
32-35	172	(12.2)	Sergeant	139	(9.9)	Tribal Police Dept.	7	(0.5)
36-39	216	(15.4)	Lieutenant	37	(2.6)	Regional Police Dept.	1	(0.1)
40-43	172	(12.2)	Captain	15	(1.1)	Full-Time Sworn Officers		
44-47	144	(10.3)	Major	4	(0.3)	0	1	(0.1)
48-51	66	(4.7)	Colonel	1	(0.1)	1	6	(0.4)
52-55	30	(2.1)	Deputy Chief	14	(1.0)	2-4	53	(3.8)
56 or older	21	(1.5)	Chief	34	(2.4)	5-9	53	(3.8)
Missing	216	(15.4)	Function			10-24	143	(10.2)
Years of Service			Patrol & Street Level	1,138	(81.0)	25-49	130	(9.3)
0-2	167	(11.9)	Line/Field Supervisor	199	(14.2)	50-99	170	(12.1)
3-5	198	(14.1)	Management	68	(4.8)	100-249	210	(14.9)
6-8	139	(9.9)	Region of United States			250-499	127	(9.0)
9-11	133	(9.5)	Northeastern States	309	(22.0)	500-999	113	(8.0)
12-14	114	(8.1)	Midwestern States	358	(25.5)	1,000 or more	399	(28.4)
15-17	82	(5.8)	Southern States	548	(39.0)	Part-Time Sworn Officers		
18-20	78	(5.5)	Western States	190	(13.5)	0	1,082	(77.0)
21-23	46	(3.3)	Level of Rurality			1	37	(2.6)
24-26	29	(2.1)	Metropolitan County	1,212	(86.3)	2-4	104	(7.4)
27 or more years	27	(1.9)	Non-Metro County	193	(13.7)	5-9	80	(5.7)
Missing	392	(27.9)	Arresting Agency			10-24	69	(4.9)
Employing Agency	396	(28.2)	Employing Agency			25-49	20	(1.4)
Another Agency	1,009	(71.8)	Another Agency			50-99	12	(0.9)
						100-249	1	(0.1)
						250-499	0	(0.0)

Table 38. Most Serious Offense Charged in Alcohol-related Police Crime Arrest Cases, 2005-2011 (*N* = 1,405)

	<i>n</i>	(%)		<i>n</i>	(%)
Driving Under the Influence	817	(58.1)	Obstructing Justice	5	(0.4)
Simple Assault	149	(10.6)	Burglary / Breaking & Entering	4	(0.3)
Aggravated Assault	103	(7.3)	Drug / Narcotic violation	5	(0.4)
Weapons Law violation	47	(3.3)	Extortion / Blackmail	4	(0.3)
Forcible Fondling	27	(1.9)	Statutory Rape	4	(0.3)
Disorderly Conduct	27	(1.9)	Indecent Exposure	4	(0.3)
Murder & Nonnegligent Manslaughter	26	(1.9)	Arson	3	(0.2)
Forcible Rape	26	(1.9)	False Pretenses / Swindle	3	(0.2)
Destruction of Property / Vandalism	23	(1.6)	Reckless Endangerment	3	(0.2)
Drunkenness	22	(1.6)	Impersonation	2	(0.1)
Liquor Law violation	19	(1.3)	Sexual Assault with an Object	2	(0.1)
All Other / Unclassified Offenses	16	(1.1)	Official Misconduct / Official Oppression	2	(0.1)
Negligent Manslaughter	14	(1.0)	Theft from Building	1	(0.1)
Intimidation	11	(0.7)	All Other / Unclassified Larceny	1	(0.1)
Hit & Run	9	(0.6)	Prostitution	1	(0.1)
False Report / False Statement	6	(0.4)	Robbery	1	(0.1)
Forcible Sodomy	5	(0.4)	Criminal Civil Rights violation	1	(0.1)
Unclassified Sex Crime	5	(0.4)	Evidence: Destroying / Tampering	1	(0.1)
Family Offenses, nonviolent	5	(0.4)	Trespass of Real Property	1	(0.1)

Table 39. Victim Characteristics in Alcohol-related Police Crime Arrest Cases, 2005-2011 (*N* = 1,405)

	<i>n</i>	(%)	(Valid %)		<i>n</i>	(%)	(Valid %)
Victim's Sex				Victim's Relationship			
Female	263	(18.7)	(52.1)	Current Spouse	42	(3.0)	(7.6)
Male	242	(17.2)	(47.9)	Former Spouse	5	(0.4)	(0.9)
Missing	900	(64.1)		Current Girlfriend or Boyfriend	45	(3.2)	(8.1)
Victim's Age				Former Girlfriend or Boyfriend	7	(0.5)	(1.3)
Birth-11	14	(1.0)	(5.0)	Child or Stepchild	19	(1.4)	(3.4)
12-13	12	(0.9)	(4.3)	Some Other Relative	6	(0.4)	(1.1)
14-15	20	(1.4)	(7.1)	Unrelated Child	47	(3.3)	(8.5)
16-17	17	(1.2)	(6.0)	Stranger or Acquaintance	382	(27.2)	(69.1)
18-19	23	(1.6)	(8.1)	Missing	852	(60.6)	
20-24	53	(3.8)	(18.7)	Victim's Law Enforcement Status			
25-32	66	(4.7)	(23.3)	Victim is Not a Police Officer	500	(35.6)	(89.6)
33-41	29	(2.1)	(10.2)	Victim is a Police Officer	58	(4.1)	(10.4)
42 or older	49	(3.5)	(17.3)	Missing	847	(60.3)	
Missing	1,122	(79.9)		Victim Adult or Child			
				Adult	495	(35.2)	(87.8)
				Child	69	(4.9)	(12.2)
				Missing	841	(59.9)	

Table 40: Police DUI Arrest Cases: Incident Events

	<i>n</i>	(%)
DUI in Privately-Owned Vehicle	836	(87.1)
DUI Traffic Accident	492	(51.2)
DUI Traffic Accident with Injuries	231	(24.1)
Refused BAC Test	195	(20.3)
DUI Traffic Accident: Officer Fled Scene	103	(10.7)
Officer in Possession of Firearm while DUI	83	(8.6)
Refused Field Sobriety Tests	81	(8.4)
DUI in Take-Home Police Vehicle	78	(8.1)
Off-Duty: Identified Self as Police Officer	77	(8.0)
DUI Traffic Accident: Officer Charged with Hit & Run	76	(7.9)
Officer Resisted Arrest	44	(4.6)
DUI <i>Actually</i> On-Duty in Police Vehicle	42	(4.4)
DUI Traffic Accident: Fatality Resulting	39	(4.1)
DUI Traffic Accident: Flipped their Car	33	(3.4)
DUI in Police Vehicle while Out of Jurisdiction	28	(2.9)
Off-Duty: Officer's Employing Agency Requires 24/7 Availability	23	(2.4)
DUI Traffic Accident: Driving in Wrong Direction	17	(1.8)
Off-Duty: Flashed Badge	16	(1.7)
DUI Traffic Accident: Driving a Motorcycle	15	(1.6)
Off-Duty: Displayed Police Weapon	14	(1.5)
DUI Traffic Accident: Officer Denied Driving	12	(1.3)
Off-Duty: Family Violence	10	(1.0)
DUI Traffic Accident: While Evading	9	(0.9)
DUI Traffic Accident: Flipped Victim's Car	4	(0.4)
Off-Duty: In Police Uniform	2	(0.2)
Off-Duty: Made an Arrest	2	(0.2)
Off-Duty: Intervened in Existing Dispute Per Policy	1	(0.1)

Table 41. Police DUI Arrest Cases: Drug-related (N = 49)

	<i>n</i>	(%)
Specific Drugs:		
Other Depressants (Depressant)	15	(30.6)
Oxycodone (Narcotic)	8	(16.3)
Cocaine (Stimulant)	5	(10.2)
Hydrocodone (Narcotic)	4	(8.2)
Other Narcotics (Narcotic)	4	(8.2)
Benzodiazepines (Depressant)	4	(8.2)
Amphetamine / Methamphetamine (Stimulant)	3	(6.1)
Marijuana (Cannabis)	3	(6.1)
Hydromorphone (Narcotic)	2	(4.1)
Other Stimulants (Stimulant)	2	(4.1)
Morphine (Narcotic)	1	(2.0)
Codeine (Narcotic)	1	(2.0)
MDMA & Analogs (Hallucinogen)	1	(2.0)
Other Anabolic Steroids (Anabolic Steroid)	1	(2.0)
Arrested Officer and Agencies:		
Officer is Male	46	(93.9)
On-Duty at Time of DUI Offense	16	(32.7)
Arresting Agency is Not Officer's Employer	34	(69.4)

Note. Categories are not mutually exclusive. Sum of (%) column \neq 100

Table 42. Bivariate Associations of Conviction in Alcohol-related Police Crime Arrest Cases

Variable Label	Variable	<i>N</i>	χ^2	<i>df</i>	<i>p</i>	<i>V</i>
Rank	V7	654	20.366	8	.009	.176
State	V11	654	95.625	48	.000	.382
Arresting Agency	V14	654	5.294	1	.021	.090
Simple Assault	V17	654	7.182	1	.007	.105
Property Destruction / Vandalism	V22	654	4.327	1	.038	.081
Forcible Fondling	V56	654	3.681	1	.055	.075
Driving Under the Influence	V67	654	11.679	1	.001	.134
Drunkenness	V68	654	4.477	1	.034	.083
Hit and Run	V72	654	3.987	1	.046	.078
Liquor Law violation	V73	654	6.721	1	.010	.101
Child Victim	V84	339	4.004	1	.045	.109
Victim's Relationship to the Officer	V85	331	23.297	7	.002	.265
Sex-related	V95	654	3.913	1	.048	.077
Driving While Female Encounter	V99	654	6.187	1	.013	.097
Officer was Demoted	V103	654	4.653	1	.031	.084
DUI-related Traffic Accident	V110	654	17.885	1	.000	.165
Injuries in a DUI-related Traffic Accident	V111	654	11.293	1	.001	.131
DUI in a Personally-owned Vehicle	V115	654	12.756	1	.000	.140
Off-Duty Ordinance On-Call 24/7	V118	654	3.612	1	.057	.074
Family Violence	V126	654	10.441	1	.001	.126
OIDV: Hands / Fist	V164	654	21.157	1	.000	.180
OIDV: Victim Injured, nonfatal	V173	654	13.340	1	.000	.143
Job Lost	joblostbin	654	12.462	1	.000	.138
Geographic Region	geogreg	654	11.270	3	.010	.131
Geographic Division	geogdiv	654	19.323	8	.013	.172

Table 43. Alcohol-related Police Crime Arrest Cases: Logistic Regression Model Predicting Conviction ($N = 330$)

	<i>B</i>	<i>SE</i>	Wald	<i>p</i>	Exp(B)	95% CI for Exp(B)	
						<i>LL</i>	<i>UL</i>
Arresting Agency is Not Arrested Officer's Employer	0.577	0.291	3.924	.048	1.781	1.006	3.153
Sex-related	1.110	0.455	5.952	.015	3.035	1.244	7.406
Driving-While-Female Encounter	-2.655	0.832	10.182	.001	0.070	0.014	0.359
DUI in a Personally-Owned-Vehicle	1.286	0.386	11.078	.001	3.619	1.697	7.719
OIDV: Weapon: Hands / Fist	-1.015	0.368	7.590	.006	0.362	0.176	0.746
Lost Job	0.937	0.288	10.601	.001	2.551	1.452	4.483
- 2 Log Likelihood	322.629						
Model Chi-Square	7.486			<.001			
Cox & Snell R^2	.156						
Nagelkerke R^2	.229						
ROC R^2	.376						
AUC	.688						
						95% CI for AUC	
						<i>LL</i>	<i>UL</i>
						.641	.734

Table 44. Bivariate Associations of Job Loss in Alcohol-related Arrest Cases

Variable Label	Variable	<i>N</i>	χ^2	<i>df</i>	<i>p</i>	<i>V</i>
Duty Status	V6	1,405	26.456	1	.000	.137
Full-Time Sworn Personnel (categorical)	V10	1,405	48.473	10	.000	.186
State	V11	1,405	106.935	50	.000	.276
Part-Time Sworn Personnel (categorical)	V12	1,405	29.408	7	.000	.145
Urban-Rural County Continuum	V13	1,405	32.022	8	.000	.151
Aggravated Assault	V16	1,405	8.017	1	.005	.076
Bribery	V19	1,405	4.919	1	.027	.059
Extortion / Blackmail	V26	1,405	8.209	1	.004	.076
Murder & Nonnegligent Manslaughter	V36	1,405	10.863	1	.001	.088
Negligent Manslaughter	V37	1,405	6.527	1	.011	.068
Kidnapping / Abduction	V39	1,405	14.689	1	.000	.102
Pornography / Obscene Material	V49	1,405	4.300	1	.038	.055
Forcible Rape	V53	1,405	20.642	1	.000	.121
Forcible Sodomy	V54	1,405	9.988	1	.002	.084
Forcible Fondling	V56	1,405	9.468	1	.002	.082
Statutory Rape	V58	1,405	8.395	1	.004	.077
Unclassified Sex Crime	V61	1,405	19.762	1	.000	.119
Weapons Law violation	V63	1,405	5.803	1	.016	.064
Driving Under the Influence	V67	1,405	52.293	1	.000	.193
Destroying / Tampering Evidence	V69	1,405	4.398	1	.036	.056
False Report / False Statement	V70	1,405	4.148	1	.042	.054
Liquor Law violation	V73	1,405	8.634	1	.003	.078
Official Misconduct	V75	1,405	6.270	1	.012	.067
Victim is a Police Officer	V82	558	5.634	1	.018	.100
Child Victim	V84	564	8.325	1	.004	.121
Victim's Relationship to Arrested Officer	V85	553	15.616	7	.029	.168
Organizational versus Against Citizenry	V90	1,405	23.750	1	.000	.130
Internal Crime Against the Organization	V91	1,405	21.321	2	.000	.123
Official Capacity	V92	1,405	40.030	1	.000	.169
Sex-related	V95	1,405	55.140	1	.000	.198
Violence-related	V96	1,405	39.284	1	.000	.167
Profit-motivated	V97	1,405	6.527	1	.011	.068
Police Sexual Violence	V98	1,405	40.277	1	.000	.169
Driving While Female Encounter	V99	1,405	5.700	1	.017	.064

Officer was Reassigned	V102	1,405	13.956	1	.000	.100
Officer was Demoted	V103	1,405	5.065	1	.024	.060
Officer's Supervisor was Disciplined	V105	1,405	8.477	1	.004	.078
Citizen Complaint as Method of Detection	V108	1,405	15.326	1	.000	.104
Conviction	V109	654	12.462	1	.000	.138
DUI in Personally-owned Vehicle	V115	1,405	17.964	1	.000	.113
Off-Duty: Agency has 24/7 On-Call Policy	V118	1,405	13.702	1	.000	.099
Off-Duty: In Uniform	V120	1,405	4.919	1	.027	.059
OIDV: Protection Order filed Against Officer	V171	1,405	5.316	1	.021	.062
42 U.S.C. §1983 Civil Defendant Sometime	V176	1,405	9.680	1	.002	.083
42 U.S.C. §1985 Civil Defendant Sometime	V177	1,405	9.651	1	.002	.083
28 U.S.C. §1441 Civil Case Removed	V179	1,405	5.189	1	.023	.061
Age (categorical)	agecat	1,405	39.806	10	.000	.168
Years of Service (categorical)	yrsvcat	1,405	31.374	10	.001	.149
Metropolitan vs. Non-Metro County	codichot	1,405	18.301	1	.000	.114
Geographic Division	geogdiv	1,405	25.037	8	.002	.133
Rank Function	rankfunc	1,405	6.496	2	.039	.068
Victim Age (categorical)	vicagecat	1,405	59.634	9	.000	.206
Victim Age Difference	vicagediff	1,405	125.538	67	.000	.299

Table 45. Alcohol-related Police Crime Arrest Cases, 2005-2011: Logistic Regression Model Predicting Job Loss ($N = 327$)

	<i>B</i>	<i>SE</i>	Wald	<i>p</i>	Exp(B)	95% CI for Exp(B)	
						<i>LL</i>	<i>UL</i>
Duty Status	1.066	0.473	5.091	.024	2.904	1.150	7.333
Sex-related	1.253	0.389	10.357	.001	3.499	1.632	7.503
Violence-related	0.866	0.310	7.802	.005	2.377	1.295	4.364
Officer was Reassigned to Another Position	-1.893	0.711	7.093	.008	0.151	0.037	0.607
Citizen Complaint as Method of Crime Detection	-1.075	0.303	12.566	< .001	0.341	0.188	0.618
Conviction	0.965	0.295	10.660	.001	2.624	1.470	4.682
28 U.S.C. §1441 Civil Case Removed to Federal Court	1.879	0.787	5.699	.017	6.549	1.400	30.639
- 2 Log Likelihood	360.536						
Model Chi-Square	68.251			<.001			
Cox & Snell R^2	.188						
Nagelkerke R^2	.258						
ROC R^2	.322						
AUC	.661						
						95% CI for AUC	
						<i>LL</i>	<i>UL</i>
						.620	.702

Table 46. Bivariate Associations of Conviction in DUI Arrest Cases

Variable Label	Variable	<i>N</i>	χ^2	<i>df</i>	<i>p</i>	<i>V</i>
Duty Status	V6	378	5.917	1	.015	.125
State	V11	378	85.253	46	.000	.475
Liquor Law violation	V73	378	7.734	1	.005	.143
Official Capacity	V92	378	6.255	1	.012	.129
Officer was Reassigned	V102	378	6.748	1	.009	.134
Officer was Demoted	V103	378	3.712	1	.054	.099
DUI-related Traffic Accident	V110	378	8.850	1	.003	.153
Injuries in a DUI-related Traffic Accident	V111	378	5.972	1	.015	.126
DUI in a Take-Home Police Vehicle	V113	378	5.060	1	.024	.116
DUI Refused BAC Test	V117	378	6.210	1	.013	.128
Off-Duty: Agency has 24/7 On-Call Policy	V118	378	5.782	1	.016	.124
Oxycodone	V133	378	4.051	1	.044	.104
Anabolic Steroids (excluding Testosterone)	V152	378	4.051	1	.044	.104
OIDV: Weapon: Verbal Threats	V167	378	4.051	1	.044	.104
OIDV: Victim Injured, nonfatal	V173	378	4.051	1	.044	.104
DUI Traffic Accident: Officer Denied Driving	V225	378	7.734	1	.005	.143
DUI in a Police Vehicle	duipveh	378	4.929	1	.026	.114
Geographic Division	geogdiv	378	25.595	8	.001	.260
Geographic Region	geogreg	378	18.376	3	.000	.220
Job Lost	joblostbin	378	6.222	1	.013	.128
Narcotics	narcotics	378	4.051	1	.044	.104
Anabolic Steroids	steroids	378	4.051	1	.044	.104

Table 47. Police DUI Arrest Cases: Logistic Regression Model Predicting Conviction ($N = 378$)

	<i>B</i>	<i>SE</i>	Wald	<i>p</i>	Exp(B)	95% CI for Exp(B)	
						<i>LL</i>	<i>UL</i>
Liquor Law violation	-2.893	1.181	6.000	.014	0.055	0.005	0.561
Official Capacity	-0.949	0.363	6.842	.009	0.387	0.190	0.788
DUI-related Traffic Accident	0.861	0.283	9.239	.002	2.366	1.358	4.123
DUI Refused BAC Test	-0.775	0.308	6.313	.012	0.461	0.252	0.843
DUI Traffic Accident: Officer Denied Driving	-2.858	1.200	5.670	.017	0.057	0.005	0.603
Job Loss	0.892	0.310	8.283	.004	2.440	1.329	4.480
- 2 Log Likelihood	334.792						
Model Chi-Square	41.842			<.001			
Cox & Snell R^2	.105						
Nagelkerke R^2	.166						
ROC R^2	.410						
AUC	.705						
						95% CI for AUC	
						<i>LL</i>	<i>UL</i>
						.639	.771

Table 48. Bivariate Associations of Job Loss in DUI Arrest Cases

Variable Label	Variable	<i>N</i>	χ^2	<i>df</i>	<i>p</i>	<i>V</i>
Duty Status	V6	960	6.657	1	.010	.083
Full-Time Sworn Personnel (categorical)	V10	960	29.056	10	.001	.174
State	V11	960	107.344	50	.000	.334
Part-Time Sworn Personnel (categorical)	V12	960	24.362	7	.001	.159
Urban to Rural Continuum	V13	960	31.714	8	.000	.182
Murder and Nonnegligent Manslaughter	V36	960	6.222	1	.013	.081
Kidnapping / Abduction	V39	960	4.346	1	.037	.067
Organizational vs. Against Citizenry	V90	960	4.555	1	.033	.069
Internal Crime Against the Organization	V91	960	7.764	2	.021	.090
Official Capacity	V92	960	17.856	1	.000	.136
Violence-related	V96	960	14.195	1	.000	.122
Officer was Reassigned	V102	960	5.850	1	.016	.078
Discussion of Agency Scandal	V107	960	9.773	1	.002	.101
Conviction	V109	378	6.222	1	.013	.128
DUI-related Traffic Accident	V110	960	6.759	1	.009	.084
Injuries in DUI-related Traffic Accident	V111	960	9.618	1	.002	.100
DUI On-Duty in Police Vehicle	V112	960	6.912	1	.009	.085
Off-Duty: Agency has 24/7 On-Call Policy	V118	960	8.080	1	.004	.092
Off-Duty: In Police Uniform	V120	960	4.346	1	.037	.067
DUI Traffic Accident: Driving in Wrong Direction	V221	960	16.158	1	.000	.130
DUI Traffic Accident: Fatality	V222	960	12.230	3	.007	.113
DUI in a Police Vehicle	DUIpveh	960	10.788	1	.001	.106
Age (categorical)	agecat	960	32.467	10	.000	.184
Years of Service (categorical)	yrsservcat	960	33.388	10	.000	.186
Metro vs. Non-Metro County	codichot	960	9.812	1	.002	.101
Geographic Region	geogreg	960	14.578	3	.002	.123
Geographic Division	geogdiv	960	38.273	8	.000	.200
Victim Age (categorical)	vicagecat	960	21.306	8	.006	.149
Victim Age Difference	vicagediff	960	80.423	54	.011	.289

Table 49. Police DUI Arrest Cases, 2005-2011: Logistic Regression Model Predicting Job Loss (N = 378)

	<i>B</i>	<i>SE</i>	Wald	<i>p</i>	Exp(B)	95% CI for Exp(B)	
						<i>LL</i>	<i>UL</i>
Full-Time Sworn Personnel (categorical)	-0.149	0.050	8.878	.003	0.862	0.781	0.950
Murder & Nonnegligent Manslaughter	1.254	0.634	3.909	.048	3.506	1.011	12.156
Official Capacity	1.076	0.332	10.525	.001	2.934	1.531	5.623
Violence-related	0.902	0.339	7.068	.008	2.465	1.268	4.794
Conviction	0.857	0.299	8.202	.004	2.357	1.311	4.238
Off-Duty: Employing Agency Requires 24/7 Availability	-2.254	1.047	4.638	.031	0.105	0.013	0.817
DUI Traffic Accident: Driving in Wrong Direction	2.149	1.081	3.951	.047	8.576	1.030	71.382
Years of Service (categorical)	0.043	0.021	4.278	.039	1.043	1.002	1.086
- 2 Log Likelihood	444.563						
Model Chi-Square	69.892			<.001			
Cox & Snell R^2	.169						
Nagelkerke R^2	.227						
ROC R^2	.436						
AUC	.718						
						95% CI for AUC	
						<i>LL</i>	<i>UL</i>
						.666	.770

Table 50. Drug-related Police Crime Arrest Cases, 2005-2011: Arrested Officers and Employing Agencies (*N* = 739)

	<i>n</i>	(%)		<i>n</i>	(%)		<i>n</i>	(%)
Sex			Officer Duty Status			Agency Type		
Male	701	(94.9)	On-Duty	444	(60.1)	Primary State Police	23	(3.1)
Female	38	(5.1)	Off-Duty	295	(39.9)	Sheriff's Office	139	(18.8)
Age			Rank			County Police Dept.	25	(3.4)
19-23	5	(0.7)	Officer	559	(75.6)	Municipal Police Dept.	527	(71.3)
24-27	53	(7.2)	Detective	70	(9.5)	Special Police Dept.	20	(2.7)
28-31	130	(17.6)	Corporal	7	(0.9)	Constable	4	(0.5)
32-35	129	(17.5)	Sergeant	45	(6.1)	Tribal Police Dept.	1	(0.2)
36-39	136	(18.4)	Lieutenant	22	(3.0)	Regional Police Dept.	0	(0.0)
40-43	84	(11.4)	Captain	5	(0.7)	Full-Time Sworn Officers		
44-47	72	(9.7)	Major	1	(0.1)	0	1	(0.1)
48-51	37	(5.0)	Colonel	0	(0.0)	1	8	(1.1)
52-55	21	(2.8)	Deputy Chief	3	(0.4)	2-4	24	(3.3)
56 or older	17	(2.3)	Chief	27	(3.7)	5-9	33	(4.5)
Missing	55	(7.4)	Function			10-24	73	(9.9)
Years of Service			Patrol & Street Level	629	(85.1)	25-49	84	(11.4)
0-2	72	(9.7)	Line/Field Supervisor	74	(10.0)	50-99	84	(11.4)
3-5	116	(15.7)	Management	36	(4.9)	100-249	58	(7.8)
6-8	87	(11.8)	Region of United States			250-499	80	(10.8)
9-11	76	(10.3)	Northeastern States	154	(20.9)	500-999	58	(7.8)
12-14	64	(8.7)	Midwestern States	145	(19.6)	1,000 or more	236	(31.9)
15-17	50	(6.8)	Southern States	346	(46.8)	Part-Time Sworn Officers		
18-20	37	(5.0)	Western States	94	(12.7)	0	551	(74.6)
21-23	21	(2.8)	Level of Rurality			1	28	(3.8)
24-26	8	(1.1)	Metropolitan County	611	(82.7)	2-4	47	(6.4)
27 or more years	21	(2.8)	Non-Metro County	128	(17.3)	5-9	48	(6.5)
Missing	187	(25.3)	Arresting Agency			10-24	49	(6.6)
			Employing Agency			25-49	11	(1.5)
			Another Agency			50-99	4	(0.5)
						100-249	1	(0.1)
						250-499	0	(0.0)

Table 51. Most Serious Offense Charged in Drug-related Police Crime Arrest Cases, 2005-2011 (N = 739)

	<i>n</i>	(%)		<i>n</i>	(%)
Drug / Narcotic violation	308	(41.7)	Forcible Rape	8	(1.1)
Robbery	60	(8.1)	Simple Assault	7	(0.9)
Driving Under the Influence	38	(5.1)	Intimidation	7	(0.9)
All Other Larceny	33	(4.5)	Stolen Property Offenses	7	(0.9)
Theft from a Building	28	(3.8)	Evidence: Destroying / Tampering	6	(0.8)
Burglary / Breaking and Entering	26	(3.5)	Arson	5	(0.7)
All Other Offenses	24	(3.2)	Murder and Nonnegligent Manslaughter	4	(0.6)
Weapons Law violation	22	(3.0)	Kidnapping / Abduction	4	(0.6)
False Pretenses / Swindle	19	(2.6)	Impersonation	3	(0.4)
Extortion / Blackmail	15	(2.0)	Theft from a Motor Vehicle	3	(0.4)
Official Misconduct / Oppression / Violation of Oath	15	(2.0)	Destruction of Property / Vandalism	2	(0.3)
Aggravated Assault	14	(1.9)	Sexual Assault with an Object	2	(0.3)
Obstruction of Justice	13	(1.8)	Other Sex Crime	2	(0.3)
False Statement / False Report	11	(1.5)	Statutory Rape	1	(0.1)
Embezzlement	10	(1.4)	Online Solicitation of a Child	1	(0.1)
Forcible Fondling	10	(1.4)	Disorderly Conduct	1	(0.1)
Civil Rights violation	10	(1.4)	Hit & Run	1	(0.1)
Bribery	9	(1.2)	Wiretapping, illegal	1	(0.1)
Counterfeiting / Forgery	9	(1.2)			

Table 52. Specific Drugs in Drug-related Police Crime Arrest Cases, 2005-2011 (N = 739)

	<i>n</i>	(%)		<i>n</i>	(%)
Specific Drugs			Drug Classes		
Cocaine (Stimulant)	233	(31.5)	Stimulants	308	(41.7)
Marijuana (Cannabis)	177	(24.0)	Narcotics	197	(26.7)
Oxycodone (Narcotic)	89	(12.0)	Cannabis	177	(24.0)
Hydrocodone (Narcotic)	69	(9.3)	Depressants	45	(6.1)
Crack (Stimulant)	58	(7.8)	Anabolic Steroids	44	(6.0)
Amphetamine / Methamphetamine (Stimulant)	53	(7.2)	Hallucinogens	23	(3.1)
Heroin (Narcotic)	50	(6.8)			
Narcotics (other)	29	(3.9)	Cases with Multiple Types of Drug Classes Present		
Anabolic Steroids (not testosterone)	29	(3.9)	0 Drug Classes	133	(18.0)
Depressants (other)	26	(3.5)	1 Drug Class	466	(63.1)
Benzodiazapines (Depressant)	19	(2.6)	2 Drug Classes	105	(14.2)
Testosterone (Anabolic Steroid)	17	(2.3)	3 Drug Classes	22	(3.0)
MDMA & Analogs (Hallucinogen)	11	(1.5)	4 Drug Classes	13	(1.8)
Morphine (Narcotic)	8	(1.1)			
Phencyclidine & Analogs (Hallucinogen)	8	(1.1)	Cases with Multiple Specific Drugs Present		
Hydromorphone (Narcotic)	5	(0.7)	0 Specific Drugs	131	(17.7)
Stimulants (other)	4	(0.5)	1 Specific Drug	415	(56.2)
Hallucinogens (other)	4	(0.5)	2 Specific Drugs	136	(18.4)
Codeine (Narcotic)	2	(0.3)	3 Specific Drugs	35	(4.7)
Gamma Hydroxybutyric Acide (Depressant)	2	(0.3)	4 Specific Drugs	10	(1.4)
			5 Specific Drugs	11	(1.5)
			6 Specific Drugs	1	(0.1)

Note. Categories are not mutually exclusive. Sum of (%) columns ≠ 100

Table 53. Victim Characteristics in Drug-related Police Crime Arrest Cases, 2005-2011 (N = 739)

	<i>n</i>	(%)	(Valid %)		<i>n</i>	(%)	(Valid %)
Victim's Sex				Victim's Relationship			
Female	52	(7.0)	(47.7)	Current Spouse	6	(0.8)	(4.4)
Male	57	(7.7)	(52.3)	Former Spouse	0	(0.0)	(0.0)
Missing	630	(85.3)		Current Girlfriend or Boyfriend	3	(0.4)	(2.2)
Victim's Age				Former Girlfriend or Boyfriend	1	(0.1)	(0.7)
Birth-11	1	(0.1)	(2.6)	Child or Stepchild	2	(0.3)	(1.4)
12-13	4	(0.5)	(10.5)	Some Other Relative	2	(0.3)	(1.4)
14-15	7	(1.0)	(18.4)	Unrelated Child	12	(1.6)	(8.7)
16-17	1	(0.1)	(2.6)	Stranger or Acquaintance	112	(15.2)	(81.2)
18-19	4	(0.5)	(10.5)	Missing	601	(81.3)	
20-24	8	(1.1)	(21.1)	Victim's Law Enforcement Status			
25-32	5	(0.7)	(13.2)	Victim is Not a Police Officer	136	(18.4)	(97.1)
33-41	3	(0.4)	(7.9)	Victim is a Police Officer	4	(0.5)	(2.9)
42 or older	5	(0.7)	(13.2)	Missing	599	(81.1)	
Missing	701	(94.9)		Victim Adult or Child			
				Adult	129	(17.5)	(90.2)
				Child	14	(1.9)	(9.8)
				Missing	596	(80.6)	

Table 54. Patterns of Drug-related Corruption in Police Crime Arrest Cases, 2005-2011 (N = 739)

	<i>n</i>	(%)		<i>n</i>	(%)
Drug Selling / Dealing / Trafficking	299	(40.5)	Other Types of Police Crime Present in Drug Cases		
Drug Personal Use	235	(31.8)	Profit-motivated Police Crime	438	(59.3)
Facilitation of the Drug Trade	172	(23.3)	Violence-related Police Crime	132	(17.9)
Theft / Shakedown	171	(23.1)	Alcohol-related Police Crime	38	(5.1)
<i>Street-Level Dealer (n = 75, 10.1%)</i>			Sex-related Police Crime	37	(5.0)
<i>Warrantless Searches (n = 69, 9.3%)</i>					
<i>Car Stops & Drug Couriers (n = 58, 7.8%)</i>			Drug Cases with Multiple Types of Police Crime		
<i>Off-Duty Robberies (n = 35, 4.7%)</i>			1 Type of Police Crime Present (just Drug-related)	226	(30.6)
<i>Illegitimate Raids / Searches (n = 33, 4.5%)</i>			2 Types of Police Crime Present	390	(52.8)
<i>Calls for Service / Radio Runs (n = 16, 2.2%)</i>			3 Types of Police Crime Present	114	(15.4)
Theft from Police Evidence Room	60	(8.1)	4 Types of Police Crime Present	9	(1.2)
Falsification	58	(7.8)			
Forged Prescription	33	(4.5)			
Planting Evidence	33	(4.5)			
Sexually-motivated Drug Corruption	25	(3.4)			
Cases with Multiple Patterns of Drug Corruption					
0 Drug Corruption Patterns Present	59	(8.0)			
1 Drug Corruption Pattern Present	316	(42.8)			
2 Drug Corruption Patterns Present	192	(26.0)			
3 Drug Corruption Patterns Present	72	(9.7)			
4 Drug Corruption Patterns Present	56	(7.6)			
5 Drug Corruption Patterns Present	35	(4.7)			
6 Drug Corruption Patterns Present	6	(0.8)			
7 Drug Corruption Patterns Present	3	(0.4)			

Note. Categories are not mutually exclusive. Sum of (%) column \neq 100

Table 55. CART Analysis Patterns of Drug-related Police Corruption (*N* = 739)

	Splitting Variable	Node 1 Variable(s)	Node 2 Variable(s)	AUC	95% CI	
					LL	UL
Specific Drugs						
Theft/Shakedown - Car Stops & Drug Couriers	Cocaine	Heroin/Marijuana	Crack	.774	.705	.843
Theft/Shakedown - Warrantless Search/Seizures	Marijuana	Cocaine	Heroin/Crack	.769	.714	.824
Theft/Shakedown - Street-Level Dealer	Cocaine	Hydrocodone/Marijuana	Amphetamine/Crack	.792	.740	.844
Drug Use	Hydrocodone	Oxycodone	Testosterone	.701	.660	.724
Drug Trafficking	Cocaine	Heroin/Marijuana	Testosterone	.685	.646	.725
Facilitation of the Drug Trade	Cocaine	Heroin/Marijuana	Marijuana	.737	.697	.777
Drug Classes						
Theft/Shakedown - Car Stops & Drug Couriers	Stimulants	Cannabis/Depressants	Narcotics/Hallucinogens	.753	.685	.821
Theft/Shakedown - Warrantless Search/Seizures	Cannabis	Narcotics/Stimulants	Anabolic Steroids/Narcotics/Hallucinogens	.753	.695	.812
Theft/Shakedown - Street-Level Dealer	Cannabis	Narcotics/Stimulants	Anabolic Steroids/Hallucinogens	.755	.697	.814
Drug Trafficking	Stimulants	Cannabis/Anabolic Steroids*	Hallucinogens/Narcotics	.696	.658	.734
Drug Use	Narcotics	Stimulants	Anabolic Steroids/Hallucinogens	.675	.632	.717
Facilitation of the Drug Trade	Stimulants	Cannabis	Depressants	.654	.608	.699

*Anabolic steroids other than testosterone

Table 56. Bivariate Associations of Conviction in Drug-related Police Crime Arrest Cases, 2005-2011

Variable Label	Variable	<i>N</i>	χ^2	<i>df</i>	<i>p</i>	<i>V</i>
State	V11	562	65.220	43	.016	.341
Arresting Agency	V14	562	13.219	1	.000	.153
Burglary / Breaking and Entering	V20	562	4.328	1	.037	.088
Drug / Narcotic Violation	V23	562	5.962	1	.015	.103
Extortion / Blackmail	V26	562	3.870	1	.049	.083
Gambling: Betting / Wagering	V32	562	6.310	1	.012	.106
Weapons Law Violation	V63	562	4.694	1	.030	.091
Obstruction of Justice	V74	562	5.436	1	.020	.098
Victim Relationship to the Arrested Officer	V85	129	15.398	6	.017	.345
Profit-motivated	V97	562	15.513	1	.000	.166
Police Sexual Violence	V98	562	5.024	1	.025	.095
Arrested Officer was Reassigned	V102	562	9.568	1	.002	.130
Officer was Suspended	V104	562	17.595	1	.000	.177
DUI: Refused BAC Test	V117	562	7.156	1	.007	.113
Family Violence	V126	562	9.044	1	.003	.127
Other Depressants	V138	562	4.289	1	.038	.087
Cocaine	V139	562	8.535	1	.003	.123
OIDV: Weapon: Hands Fists	V164	562	9.146	1	.002	.128
OIDV: Weapon: Other Body Parts	V165	562	4.489	1	.034	.089
OIDV: Victim Injured, Nonfatal	V173	562	6.758	1	.009	.110
Drugs: Personal Use / Using Drugs	V196	562	3.762	1	.052	.082
Drugs: Selling / Dealing / Trafficking	V197	562	15.265	1	.000	.165
Drugs: Shakedown from Car Stops	V206	562	4.878	1	.027	.093
Job Lost binary	joblossb	562	12.267	1	.000	.148
Drugs: Stimulants	stimulant	562	9.442	1	.002	.130
Metropolitan vs. NonMetro County	codichot	562	5.843	1	.016	.102
Victim Age Categorical	vicagecat	562	47.832	9	.000	.292
Victim Age Difference	vicagediff	562	63.847	25	.000	.337

Table 57. Drug-related Police Crime Arrest Cases: Logistic Regression Model Predicting Conviction ($N = 129$)

	<i>B</i>	<i>SE</i>	Wald	<i>p</i>	Exp(B)	95% CI for Exp(B)	
						<i>LL</i>	<i>UL</i>
Obstruction of Justice	-1.703	0.751	5.141	.023	0.182	0.042	0.794
Victim Relationship to Arrested Officer	0.471	0.171	7.545	.006	1.601	1.144	2.240
Suspended from Job	-2.061	0.699	8.687	.003	0.127	0.032	0.501
Lost Job	1.521	0.606	6.302	.012	4.575	1.396	14.996
Victim Age Categorical	-0.096	0.040	5.795	.016	0.909	0.840	0.982
- 2 Log Likelihood	86.361						
Model Chi-Square	34.589			<.001			
Cox & Snell R^2	.235						
Nagelkerke R^2	.387						
ROC R^2	.698						
AUC	.849						
						95% CI for AUC	
						<i>LL</i>	<i>UL</i>
						.761	.937

Table 58. Bivariate Associations of Job Loss in Drug-related Police Crime Arrest Cases, 2005-2011

Variable Label	Variable	N	χ^2	df	p	V
Year of Arrest	V2	739	56.885	6	.000	.277
Age	V3	739	62.818	45	.041	.303
Duty Status	V6	739	12.598	1	.000	.131
Full-Time Sworn Personnel	V10	739	26.219	10	.003	.188
Arresting Agency	V14	739	7.304	1	.007	.099
Counterfeiting / Forgery	V21	739	4.142	1	.042	.075
Drug / Narcotic Violation	V23	739	4.854	1	.028	.081
Theft from a Building	V43	739	4.684	1	.030	.080
Theft / All Other Larceny	V47	739	4.227	1	.040	.076
Pornography / Obscene Material	V49	739	16.780	1	.000	.151
Weapons Law Violation	V63	739	13.652	1	.000	.136
Driving Under the Influence	V67	739	19.044	1	.000	.161
Drunkenness	V68	739	7.152	1	.007	.090
Trespass of Real Property	V78	739	7.152	1	.007	.098
Official Capacity	V92	739	18.828	1	.000	.160
Alcohol-related	V94	739	21.590	1	.000	.171
Profit-motivated	V97	739	13.973	1	.000	.138
Reassigned	V102	739	20.894	1	.000	.168
Suspended	V104	739	25.124	1	.000	.184
Supervisor was Disciplined	V105	739	11.138	1	.001	.123
Chief is Under Scrutiny	V106	739	8.228	1	.004	.106
Officer was Convicted	V109	739	12.267	1	.000	.148
DUI-related Traffic Accident	V110	739	4.555	1	.033	.079
DUI On-Duty in a Police Vehicle	V112	739	8.471	1	.004	.107
DUI in Police Vehicle Outside Jurisdiction	V114	739	7.152	1	.007	.098
Off-Duty: Identified Self as an Officer	V119	739	4.533	1	.033	.078
DUI in Possession of a Firearm	V128	739	4.818	1	.028	.081
Heroin	V129	739	7.998	1	.005	.104
Other Hallucinogens	V147	739	3.969	1	.046	.073
28 USC § 1441 Civil Action Removed	V179	739	5.019	1	.025	.082
18 USC § 242 Criminal Deprivation of Rights	V181	739	4.709	1	.030	.080
Drugs: Selling / Dealing / Trafficking	V197	739	7.430	1	.006	.100
Drugs: Forged Prescription	V198	739	15.890	1	.000	.147
Drugs: facilitating Drug Trade	V201	739	10.467	1	.001	.119
Drugs: Shakedowns from Car Stops	V206	739	4.636	1	.031	.079
Drugs: Theft from Evidence Room	V208	739	10.110	1	.001	.117
Drugs: Falsification	V209	739	4.163	1	.041	.075
Drugs: Narcotics	Narcotic	739	6.864	1	.009	.096
DUI in a Police Vehicle	DUI in Pol	739	7.843	1	.005	.103
Metropolitan County vs. Nonmetro County	CoDichot	739	4.470	1	.034	.078
Victim Age Difference	VicAgeDif	739	39.386	26	.045	.231

Table 59. Drug-related Police Crime Arrest Cases, 2005-2011: Logistic Regression Model Predicting Job Loss ($N = 535$)

	<i>B</i>	<i>SE</i>	Wald	<i>p</i>	Exp(B)	95% CI for Exp(B)	
						<i>LL</i>	<i>UL</i>
Year of Officer's Arrest	0.544	0.075	52.053	< .001	1.723	1.486	1.997
Counterfeiting / Forgery	-1.718	0.818	4.405	.036	0.179	0.036	0.893
Alcohol-related Police Crime	-1.341	0.455	8.668	.003	0.262	0.107	0.639
Officer's Chief is Under Scrutiny as a Result of Arrest	-0.989	0.413	5.738	.017	0.372	0.166	0.836
Conviction on Any Offense Charged	0.917	0.314	8.538	.003	2.503	1.353	4.631
28 U.S.C. §1441 Civil Rights Case Removed	1.895	0.532	12.678	< .001	6.654	2.344	18.886
Falsification in a Drug-related Criminal Case	-1.183	0.405	8.521	.004	0.306	0.138	0.678
Narcotics	1.452	0.390	13.882	< .001	4.272	1.990	9.169
Non-Metropolitan County	0.946	0.397	5.694	.017	2.576	1.184	5.603
- 2 Log Likelihood	440.566						
Model Chi-Square	131.461			<.001			
Cox & Snell R^2	.218						
Nagelkerke R^2	.332						
ROC R^2	.634						
AUC	.817						
						95% CI for AUC	
						<i>LL</i>	<i>UL</i>
						.776	.859

Table 60. Violence-related Police Crime Arrest Cases, 2005-2011: Arrested Officers and Employing Agencies (*N* = 3,328)

	<i>n</i>	(%)		<i>n</i>	(%)		<i>n</i>	(%)
Sex			Officer Duty Status			Agency Type		
Male	3,194	(96.0)	On-Duty	1,173	(35.2)	Primary State Police	118	(3.5)
Female	134	(4.0)	Off-Duty	2,155	(64.8)	Sheriff's Office	523	(15.7)
Age			Rank			County Police Dept.	90	(2.7)
19-23	74	(2.2)	Officer	2,656	(79.8)	Municipal Police Dept.	2,504	(75.2)
24-27	305	(9.2)	Detective	141	(4.2)	Special Police Dept.	77	(2.3)
28-31	489	(14.7)	Corporal	64	(1.9)	Constable	6	(0.2)
32-35	513	(15.4)	Sergeant	269	(8.1)	Tribal Police Dept.	9	(0.3)
36-39	542	(16.3)	Lieutenant	69	(2.1)	Regional Police Dept.	1	(0.0)
40-43	441	(13.3)	Captain	21	(0.6)	Full-Time Sworn Officers		
44-47	288	(8.7)	Major	3	(0.1)	0	24	(0.7)
48-51	149	(4.5)	Colonel	0	(0.0)	1	31	(0.9)
52-55	75	(2.3)	Deputy Chief	16	(0.5)	2-4	130	(3.9)
56 or older	67	(2.0)	Chief	89	(2.7)	5-9	190	(5.7)
Missing	385	(11.6)	Function			10-24	311	(9.3)
Years of Service			Patrol & Street Level	2,797	(84.0)	25-49	338	(10.2)
0-2	398	(12.0)	Line/Field Supervisor	402	(12.1)	50-99	317	(9.5)
3-5	514	(15.4)	Management	129	(3.9)	100-249	399	(12.0)
6-8	350	(10.5)	Region of United States			250-499	329	(9.9)
9-11	296	(8.9)	Northeastern States	715	(21.5)	500-999	272	(8.2)
12-14	262	(7.9)	Midwestern States	664	(20.0)	1,000 or more	987	(29.7)
15-17	193	(5.8)	Southern States	1,386	(41.6)	Part-Time Sworn Officers		
18-20	174	(5.2)	Western States	563	(16.9)	0	2,489	(74.8)
21-23	68	(2.0)	Level of Rurality			1	90	(2.7)
24-26	57	(1.7)	Metropolitan County	2,880	(86.5)	2-4	282	(8.5)
27 or more years	60	(1.8)	Non-Metro County	448	(13.5)	5-9	207	(6.2)
Missing	956	(28.7)	Arresting Agency			10-24	165	(5.0)
Employing Agency	1,228	(36.9)	Employing Agency	1,228	(36.9)	25-49	63	(1.9)
Another Agency	2,100	(63.1)	Another Agency	2,100	(63.1)	50-99	26	(0.8)
						100-249	5	(0.2)
						250-499	1	(0.0)

Table 61. Most Serious Offense Charged in Violence-related Police Crime Arrest Cases, 2005-2011 (*N* = 3,328)

	<i>n</i>	(%)		<i>n</i>	(%)
Simple Assault	870	(26.4)	Statutory Rape	24	(0.7)
Aggravated Assault	570	(17.1)	Obstruction of Justice	18	(0.5)
Forcible Fondling	352	(10.6)	Restraining Order violation	17	(0.5)
Forcible Rape	322	(9.7)	False Report / False Statement	14	(0.4)
Intimidation	200	(6.0)	Bribery	12	(0.4)
Murder / Nonnegligent Manslaughter	104	(3.1)	Vehicle Hit & Run	12	(0.4)
Unclassified / All Other Offenses	99	(3.0)	Sexual Assault with an Object	10	(0.3)
Forcible Sodomy	94	(2.8)	Drug / Narcotic violation	9	(0.3)
Robbery	92	(2.8)	Unclassified / All Other Larceny	8	(0.2)
Civil Rights violation (criminal)	61	(1.8)	Extortion / Blackmail	7	(0.2)
Weapons Law violation	57	(1.7)	False Pretenses / Swindle	5	(0.2)
Disorderly Conduct	55	(1.7)	Indecent Exposure	5	(0.2)
Unclassified / Other Sex Crime	47	(1.4)	Family Offenses, nonviolent	4	(0.1)
Negligent Manslaughter	43	(1.3)	Pornography / Obscene Material	3	(0.1)
Burglary / Breaking & Entering	38	(1.1)	Prostitution	3	(0.1)
Official Misconduct / Official Oppression	38	(1.1)	Drunkenness	3	(0.1)
Arson	32	(1.0)	Trespass of Real Property	3	(0.1)
Driving Under the Influence	32	(1.0)	Incest	2	(0.1)
Kidnapping / Abduction	30	(0.9)	Impersonation	1	(0.0)
Destruction of Property / Vandalism	24	(0.7)	Online Solicitation of a Child	1	(0.0)

Table 62. Victim Characteristics in Violence-related Police Crime Arrest Cases, 2005-2011 (*N* = 3,328)

	<i>n</i>	(%)	(Valid %)		<i>n</i>	(%)	(Valid %)
Victim's Sex				Victim's Relationship			
Female	1,841	(55.3)	(62.1)	Current Spouse	336	(10.1)	(10.9)
Male	1,124	(33.8)	(37.9)	Former Spouse	59	(1.8)	(1.9)
Missing	363	(10.9)		Current Girlfriend or Boyfriend	195	(5.9)	(6.4)
Victim's Age				Former Girlfriend or Boyfriend	118	(3.5)	(3.8)
Birth-11	163	(4.9)	(11.1)	Child or Stepchild	159	(4.8)	(5.2)
12-13	112	(3.4)	(7.7)	Some Other Relative	84	(2.5)	(2.7)
14-15	174	(5.2)	(11.9)	Unrelated Child	451	(13.6)	(14.7)
16-17	134	(4.0)	(9.1)	Stranger or Acquaintance	1,668	(50.1)	(54.3)
18-19	96	(2.9)	(6.6)	Missing	258	(7.8)	
20-24	180	(5.4)	(12.3)	Victim's Law Enforcement Status			
25-32	252	(7.6)	(17.2)	Victim is Not a Police Officer	2,912	(87.5)	(93.8)
33-41	187	(5.6)	(12.8)	Victim is a Police Officer	194	(5.8)	(6.2)
42 or older	165	(5.0)	(11.3)	Missing	3,106	(93.3)	
Missing	1,865	(56.0)		Victim Adult or Child			
				Adult	2,416	(72.6)	(78.1)
				Child	676	(20.3)	(21.9)
				Missing	3,092	(7.1)	

Table 63. Bivariate Associations of Conviction in Violence-related Arrest Cases

Variable Label	Variable	<i>N</i>	χ^2	<i>df</i>	<i>p</i>	<i>V</i>
Year of Arrest	V2	1,984	28.951	6	.000	.121
Gender	V5	1,984	3.830	1	.050	.044
Rank	V7	1,984	21.647	8	.006	.104
Full-Time Sworn Personnel (categorical)	V10	1,984	31.265	10	.001	.126
State	V11	1,984	98.550	49	.000	.223
Part-Time Sworn Personnel (categorical)	V12	1,984	15.057	7	.035	.087
Aggravated Assault	V16	1,984	11.233	1	.001	.075
Simple Assault	V17	1,984	69.186	1	.000	.187
Bribery	V19	1,984	8.886	1	.003	.067
Burglary	V20	1,984	7.994	1	.005	.063
Drug / Narcotic violation	V23	1,984	14.321	1	.000	.085
Extortion / Blackmail	V26	1,984	13.069	1	.000	.081
Murder & Nonnegligent Manslaughter	V36	1,984	5.960	1	.015	.055
Kidnapping / Abduction	V39	1,984	3.587	1	.058	.043
Pornography / Obscene Material	V49	1,984	13.069	1	.000	.081
Robbery	V52	1,984	20.997	1	.000	.103
Forcible Rape	V53	1,984	16.238	1	.000	.090
Forcible Sodomy	V54	1,984	23.453	1	.000	.109
Forcible Fondling	V56	1,984	36.773	1	.000	.136
Statutory Rape	V58	1,984	5.342	1	.021	.052
Stolen Property Offenses	V62	1,984	4.077	1	.043	.045
Weapons Law violation	V63	1,984	6.206	1	.013	.056
Criminal Deprivation of Civil Rights	V65	1,984	6.702	1	.010	.058
Driving Under the Influence	V67	1,984	9.695	1	.002	.070
Family Offenses, nonviolent	V71	1,984	7.876	1	.005	.063
Gender of Victim	V81	1,798	6.885	1	.009	.062
Victim Age	V83	962	96.014	73	.037	.316
Child Victim	V84	1,864	23.214	1	.000	.112
Victim's Relationship to Arrested Officer	V85	1,855	77.089	7	.000	.204
Internal Crime Against the Organization	V91	1,984	14.666	2	.001	.086
Drug-related	V93	1,984	20.845	1	.000	.103
Alcohol-related	V94	1,984	4.524	1	.033	.048
Sex-related	V95	1,984	85.756	1	.000	.208
Profit-motivated	V97	1,984	33.007	1	.000	.129

Police Sexual Violence	V98	1,984	38.540	1	.000	.139
Driving While Female Encounter	V99	1,984	11.554	1	.001	.076
Suspension	V104	1,984	9.249	1	.002	.068
DUI-related Traffic Accident	V110	1,984	8.644	1	.003	.066
Injuries in a DUI-related Traffic Accident	V111	1,984	7.891	1	.005	.063
DUI in a Privately-owned Vehicle	V115	1,984	8.452	1	.004	.065
DUI Refused BAC Test	V117	1,984	4.589	1	.032	.048
Off-Duty: Agency has 24/7 On-Call Policy	V118	1,984	4.485	1	.034	.048
Off-Duty: Intervened in Existing Dispute	V125	1,984	3.944	1	.047	.045
Family Violence	V126	1,984	38.595	1	.000	.139
Hydrocodone	V131	1,984	4.077	1	.043	.045
Cocaine	V139	1,984	21.445	1	.000	.104
Marijuana	V148	1,984	16.049	1	.000	.090
OIDV: Weapon: Hands / Fist	V164	1,984	50.787	1	.000	.160
OIDV: Weapon: Miscellaneous Objects	V166	1,984	3.739	1	.053	.043
OIDV: Weapon: Verbal Threats	V167	1,984	4.901	1	.027	.050
OIDV: Confiscated Gun was Returned	V169	1,984	10.465	1	.001	.073
OIDV: Protection Order Filed	V171	1,984	4.372	1	.037	.047
OIDV: Victim Injured, nonfatal	V173	1,984	55.748	1	.000	.168
OIDV: Victim Injured, fatal	V174	1,984	7.641	1	.006	.062
42 U.S.C. §1981 Civil Defendant	V175	1,984	3.673	1	.055	.043
42 U.S.C. §1997 Civil / Plaintiff is Prisoner	V178	1,984	4.268	1	.039	.046
Drugs: Selling / Dealing / Trafficking	V197	1,984	17.235	1	.000	.093
Drugs: Sexually-motivated Drug Crime	V199	1,984	6.931	1	.008	.059
Drugs: Facilitating Drug Trade	V201	1,984	6.642	1	.010	.058
Drugs: Shakedown from Street Dealers	V202	1,984	16.055	1	.000	.090
Drugs: Shakedown from Warrantless Search	V204	1,984	14.022	1	.000	.084
Drugs: Shakedown from Car Stops	V206	1,984	18.611	1	.000	.097
Drugs: Shakedown from Off-Duty Robbery	V207	1,984	9.980	1	.002	.071
Drugs: Theft from Police Evidence Room	V208	1,984	3.944	1	.047	.045
Drugs: Shakedowns (aggregate)	V210	1,984	25.915	1	.000	.114
Job Lost	joblostbin	1,984	254.985	1	.000	.358
Narcotics	narcotics	1,984	4.935	1	.026	.050
Stimulants	stimulants	1,984	21.792	1	.000	.105
Cannabis	cannabis	1,984	16.049	1	.000	.090
Age (categorical)	agecat	1,984	33.356	10	.000	.130

Years of Service (categorical)	yrsercat	1,984	40.562	10	.000	.143
Geographic Region	geogreg	1,984	8.678	3	.034	.066
Geographic Division	geogdiv	1,984	20.397	8	.009	.101
Rank Function	rankfunc	1,984	9.786	2	.007	.070
Victim Age (categorical)	vicagecat	1,984	27.714	9	.001	.118

Table 64. Violence-related Police Crime Arrest Cases: Logistic Regression Model Predicting Conviction ($N = 954$)

	<i>B</i>	<i>SE</i>	Wald	<i>p</i>	Exp(B)	95% CI for Exp(B)	
						<i>LL</i>	<i>UL</i>
Full-Time Sworn Personnel (categorical)	-0.086	0.031	7.915	.005	0.917	0.864	0.974
Burglary / Breaking & Entering	2.526	1.097	5.307	.021	12.506	1.458	107.281
Pornography / Obscene Material	2.206	1.048	4.433	.035	9.079	1.165	70.781
Forcible Sodomy	0.997	0.422	5.592	.018	2.711	1.186	6.197
Criminal Deprivation of Civil Rights	1.370	0.469	8.543	.003	3.934	1.570	9.858
Sex-related	0.626	0.626	0.181	.001	1.870	1.310	2.668
DUI in a Personally-Owned Vehicle	2.560	1.071	5.713	.017	12.936	1.585	105.554
OIDV Victim Injured, fatal	1.995	0.650	9.432	.002	7.351	2.058	26.257
Job Loss	1.726	0.165	108.819	< .001	5.619	4.063	7.772
Years of Service (categorical)	0.047	0.014	11.794	.001	1.049	1.021	1.077
- 2 Log Likelihood	948.456						
Model Chi-Square	256.077			<.001			
Cox & Snell R^2	.235						
Nagelkerke R^2	.328						
ROC R^2	.482						
AUC	.741					95% CI for AUC	
						<i>LL</i>	<i>UL</i>
						.718	.764

Table 65. Bivariate Associations of Job Loss in Violence-related Arrest Cases

Variable Label	Variable	<i>N</i>	χ^2	<i>df</i>	<i>p</i>	<i>V</i>
Year of Arrest	V2	3,328	146.477	6	.000	.210
Age	V3	2,943	67.607	50	.049	.152
Years of Service	V4	2,372	55.941	38	.030	.154
Gender	V5	3,328	8.369	1	.004	.050
Duty Status	V6	3,328	91.844	1	.000	.166
Rank	V7	3,328	18.818	8	.016	.075
Type of Agency	V9	3,328	25.826	7	.001	.088
Full-Time Sworn Personnel (categorical)	V10	3,328	55.100	10	.000	.129
State	V11	3,328	141.569	49	.000	.206
Part-Time Sworn Personnel (categorical)	V12	3,328	39.679	8	.000	.109
Urban to Rural Continuum	V13	3,328	42.904	8	.000	.114
Aggravated Assault	V16	3,328	10.964	1	.001	.057
Simple Assault	V17	3,328	128.940	1	.000	.197
Bribery	V19	3,328	35.502	1	.000	.103
Burglary	V20	3,328	4.699	1	.030	.038
Drug / Narcotic violation	V23	3,328	14.424	1	.000	.066
Impersonation	V29	3,328	4.526	1	.033	.037
Kidnapping / Abduction	V39	3,328	25.636	1	.000	.088
Theft from a Building	V43	3,328	5.433	1	.020	.040
Pornography / Obscene Material	V49	3,328	7.899	1	.005	.049
Robbery	V52	3,328	19.475	1	.000	.076
Forcible Rape	V53	3,328	62.366	1	.000	.137
Forcible Sodomy	V54	3,328	17.201	1	.000	.072
Sexual Assault with an Object	V55	3,328	7.626	1	.006	.048
Forcible Fondling	V56	3,328	137.226	1	.000	.203
Statutory Rape	V58	3,328	13.894	1	.000	.065
On-Line Solicitation of a Child	V60	3,328	4.786	1	.029	.038
Unclassified Sex Crimes	V61	3,328	54.740	1	.000	.128
Stolen Property Offenses	V62	3,328	7.249	1	.007	.047
Criminal Deprivation of Civil Rights	V65	3,328	20.843	1	.000	.079
Disorderly Conduct	V66	3,328	34.355	1	.000	.102
Evidence: Destroying / Tampering	V69	3,328	4.641	1	.031	.037
Official Misconduct	V75	3,328	21.145	1	.000	.080
Victim Gender	V81	2,965	12.413	1	.000	.065

Victim is a Police Officer	V82	3,106	3.870	1	.049	.035
Victim Age	V83	1,463	100.641	76	.031	.262
Child Victim	V84	3,092	38.888	1	.000	.112
Victim's Relationship to Arrested Officer	V85	3,070	153.358	7	.000	.224
Organizational vs. Against Citizenry	V90	3,328	7.809	1	.005	.048
Internal Crime Against the Organization	V91	3,328	18.888	2	.000	.075
Official Capacity	V92	3,328	83.335	1	.000	.158
Drug-related	V93	3,328	9.875	1	.002	.054
Sex-related	V95	3,328	284.771	1	.000	.293
Profit-motivated	V97	3,328	21.423	1	.000	.080
Police Sexual Violence	V98	3,328	151.504	1	.000	.213
Driving While Female Encounter	V99	3,328	71.090	1	.000	.146
Officer was Reassigned	V102	3,328	46.978	1	.000	.119
Officer was Demoted	V103	3,328	6.491	1	.011	.044
Officer was Suspended	V104	3,328	58.545	1	.000	.133
Officer's Supervisor was Disciplined	V105	3,328	9.467	1	.002	.053
Officer's Chief is Under Scrutiny	V106	3,328	15.225	1	.000	.068
Crime Detected by Citizen Complaint	V108	3,328	7.273	1	.007	.047
Conviction	V109	1,984	254.985	1	.000	.358
DUI: Officer Resisted Arrest	V127	3,328	3.808	1	.051	.034
Off-Duty: Showed a Police Weapon	V121	3,328	12.422	1	.000	.061
Family Violence	V126	3,328	122.943	1	.000	.192
Heroin	V129	3,328	5.433	1	.020	.040
Hydrocodone	V131	3,328	7.249	1	.007	.047
Oxycodone	V133	3,328	6.521	1	.011	.044
Cocaine	V139	3,328	3.944	1	.047	.034
Marijuana	V148	3,328	7.722	1	.005	.048
OIDV: Weapon: Hands / Fist	V164	3,328	54.925	1	.000	.128
OIDV: Weapon: Other Body Parts	V165	3,328	4.143	1	.042	.035
OIDV: Weapon: Misc. Objects	V166	3,328	12.252	1	.000	.061
OIDV: Gun was Confiscated	V168	3,328	7.830	1	.005	.049
OIDV: Confiscated Gun was Later Returned	V169	3,328	5.264	1	.022	.040
OIDV: Protection Order Filed	V171	3,328	4.365	1	.037	.036
OIDV: Victim Injured, nonfatal	V173	3,328	32.927	1	.000	.099
OIDV: Victim Injured, fatal	V174	3,328	4.269	1	.039	.036
42 U.S.C. §1981 Civil Defendant	V175	3,328	8.082	1	.004	.049

42 U.S.C. §1983 Civil Defendant	V176	3,328	15.066	1	.000	.067
42 U.S.C. §1997 Civil Plaintiff is a Prisoner	V178	3,328	5.053	1	.025	.039
28 U.S.C. §1441 Civil Case Removed	V179	3,328	28.434	1	.000	.092
18 U.S.C. §242 Criminal Defendant	V181	3,328	46.552	1	.000	.118
Drugs: Using / Personal Use	V196	3,328	9.336	1	.002	.053
Drugs: Selling / Dealing / Trafficking	V197	3,328	17.818	1	.000	.073
Drugs: Shakedown from Car Stops	V206	3,328	9.421	1	.002	.053
Drugs: Shakedown from Off-Duty Robbery	V207	3,328	8.384	1	.004	.050
Drugs: Shakedown (aggregate)	V210	3,328	5.489	1	.019	.041
Narcotics	narcotic	3,328	11.855	1	.001	.060
Depressants	depress	3,328	4.526	1	.033	.037
Stimulants	stimulant	3,328	6.935	1	.008	.046
Cannabis	cannabis	3,328	7.722	1	.005	.048
Age (categorical)	agecat	3,328	91.126	10	.000	.165
Years of Service (categorical)	yrsvcat	3,328	90.546	10	.000	.165
Metro versus Non-Metro County	codichot	3,328	13.177	1	.000	.063
Geographic Region	geogreg	3,328	48.162	3	.000	.120
Geographic Division	geogdiv	3,328	53.265	8	.000	.127
Victim Age (categorical)	vicagecat	3,328	49.257	9	.000	.122
Victim Age Difference	vicagediff	3,328	140.586	99	.004	.206

Table 66. Violence-related Police Crime Arrest Cases: Logistic Regression Model Predicting Job Loss ($N = 692$)

	<i>B</i>	<i>SE</i>	Wald	<i>p</i>	Exp(B)	95% CI for Exp(B)	
						<i>LL</i>	<i>UL</i>
Year of Arrest	0.411	0.059	49.043	< .001	1.509	1.345	1.693
Victim Gender	-0.572	0.260	4.858	.028	0.564	0.339	0.939
Victim's Relationship to the Arrested Officer	0.219	0.062	12.561	< .001	1.244	1.103	1.404
Official Capacity	-0.672	0.253	7.029	.008	0.511	0.311	0.839
Police Sexual Violence	1.352	0.351	14.843	< .001	3.864	1.943	7.685
Officer was Reassigned to Another Position	-1.224	0.503	5.930	.015	0.294	0.110	0.787
Officer was Suspended	-1.462	0.291	25.230	< .001	0.232	0.131	0.410
Conviction	1.943	0.219	78.621	< .001	6.978	4.542	10.721
28 U.S.C. §1441 Civil Case Removed to Federal Court	1.215	0.383	10.079	.001	3.370	1.592	7.136
Cannabis	-2.841	0.852	11.105	.001	0.058	0.011	0.310
Age (categorical)	-0.105	0.052	4.046	.044	0.900	0.813	0.997
- 2 Log Likelihood	617.555						
Model Chi-Square	250.874			<.001			
Cox & Snell R^2	.304						
Nagelkerke R^2	.425						
ROC R^2	.536						
AUC	.768						
						95% CI for AUC	
						<i>LL</i>	<i>UL</i>
						.744	.791

Table 67. Bivariate Associations of Conviction in Officer-involved Domestic Violence Arrest Cases

Variable Label	Variable	<i>N</i>	χ^2	<i>df</i>	<i>p</i>	<i>V</i>
Year of Arrest	V2	497	15.413	6	.017	.176
State	V11	497	80.273	46	.001	.402
Simple Assault	V17	497	29.509	1	.000	.244
Burglary	V20	497	3.927	1	.048	.089
Property Destruction / Vandalism	V22	497	9.992	1	.002	.142
Murder and Nonnegligent Manslaughter	V36	497	14.147	1	.000	.169
Pornography / Obscene Material	V49	497	5.826	1	.016	.108
Forcible Rape	V53	497	11.871	1	.001	.155
Forcible Sodomy	V54	497	4.626	1	.031	.096
Forcible Fondling	V56	497	24.159	1	.000	.220
Obstruction of Justice	V74	497	7.533	1	.006	.123
Official Misconduct	V75	497	7.521	1	.006	.123
Child Victim	V84	486	13.968	1	.000	.170
Victim's Relationship to Arrested Officer	V85	480	27.127	7	.000	.238
Sex-related	V95	497	34.222	1	.000	.262
OIDV: Weapon: Personally-owned Gun	V157	497	7.379	1	.007	.122
OIDV: Weapon: Hands / Fist	V164	497	14.263	1	.000	.169
OIDV: Weapon: Other Body Parts	V165	497	14.351	1	.000	.170
OIDV: Confiscated Gun was Returned	V169	497	5.982	1	.014	.110
OIDV: Officer Violated Protection Order	V172	497	4.603	1	.032	.096
OIDV: Victim Injured, nonfatal	V173	497	17.631	1	.000	.188
OIDV: Victim Injured, fatal	V174	497	15.862	1	.000	.179
Lost Job	joblost	497	62.928	1	.000	.356
Geographic Region	geogreg	497	19.175	3	.000	.196
Geographic Division	geogdiv	497	24.938	8	.002	.224
Victim Age (categorical)	vicagecat	497	28.296	9	.001	.239

Table 68. Officer-involved Domestic Violence Arrest Cases: Logistic Regression Model Predicting Conviction ($N = 480$)

	<i>B</i>	<i>SE</i>	Wald	<i>p</i>	Exp(B)	95% CI for Exp(B)	
						<i>LL</i>	<i>UL</i>
Destruction of Property / Vandalism	2.176	0.682	10.178	.001	8.807	2.314	33.516
Obstruction of Justice	2.950	1.106	7.118	.008	19.115	2.188	167.003
Victim's Relationship to the Arrested Officer	0.133	0.058	5.141	.023	1.142	1.018	1.280
Sex-related	1.526	0.326	21.909	< .001	4.602	2.428	8.720
OIDV: Weapon: Personally-owned Gun	0.809	0.401	4.074	.044	2.246	1.024	4.927
OIDV: Officer Violated an Order of Protection	1.547	0.599	6.663	.010	4.699	1.451	15.213
OIDV: Victim Injured, nonfatal	-0.587	0.228	6.620	.010	0.556	0.356	0.870
OIDV: Victim Injured, fatal	2.048	0.660	9.622	.002	7.752	2.125	28.278
Job Loss	1.385	0.226	37.730	< .001	3.996	2.568	6.216
Geographic Region	-0.287	0.110	6.764	.009	0.751	0.605	0.932
- 2 Log Likelihood	497.342						
Model Chi-Square	163.272			<.001			
Cox & Snell R^2	.288						
Nagelkerke R^2	.386						
ROC R^2	.640						
AUC	.820						
						95% CI for AUC	
						<i>LL</i>	<i>UL</i>
						.782	.858

Table 69. Bivariate Associations of Job Loss in Officer-involved Domestic Violence Arrest Cases

Variable Label	Variable	<i>N</i>	χ^2	<i>df</i>	<i>p</i>	<i>V</i>
Year of Arrest	V2	961	41.162	6	.000	.207
Duty Status	V6	961	4.876	1	.027	.071
Full-Time Sworn Personnel (categorical)	V10	961	31.600	10	.000	.181
State	V11	961	81.166	49	.003	.291
Part-Time Sworn Personnel (categorical)	V12	961	15.748	8	.046	.128
Urban to Rural County Continuum	V13	961	19.372	8	.013	.142
Simple Assault	V17	961	25.197	1	.000	.162
Murder & Nonnegligent Manslaughter	V36	961	12.668	1	.000	.115
Kidnapping / Abduction	V39	961	8.129	1	.004	.092
Pornography / Obscene Material	V49	961	7.008	1	.008	.085
Forcible Rape	V53	961	22.061	1	.000	.152
Forcible Fondling	V56	961	39.122	1	.000	.202
Indecent Exposure	V59	961	4.567	1	.033	.069
Unclassified Sex Crime	V61	961	10.256	1	.001	.103
Stolen Property Offenses	V62	961	6.706	1	.010	.084
Official Misconduct	V75	961	7.309	1	.007	.087
Unclassified / All Other Offenses	V80	961	11.681	1	.001	.110
Child Victim	V84	929	18.080	1	.000	.140
Victim's Relationship to Arrested Officer	V85	910	26.984	7	.000	.172
Official Capacity	V92	961	4.583	1	.032	.069
Drug-related	V93	961	5.677	1	.017	.077
Sex-related	V95	961	51.384	1	.000	.231
Police Sexual Violence	V98	961	6.706	1	.010	.084
Officer was Reassigned	V102	961	11.172	1	.001	.108
Officer was Suspended	V104	961	14.446	1	.000	.123
Officer was Convicted	V109	497	62.928	1	.000	.356
Unclassified / Other Depressants	V138	961	5.024	1	.025	.072
OIDV: Weapon: Other Body Parts	V165	961	25.743	1	.000	.164
OIDV: Weapon: Verbal Threats	V167	961	5.311	1	.021	.074
OIDV: Officer Violated Protection Order	V172	961	4.389	1	.036	.068
OIDV: Victim Injured, fatal	V173	961	15.351	1	.000	.126
28 U.S.C. §1441 Civil Case Removed	V179	961	4.908	1	.027	.071
Drugs: Sexually-motivated Drug Crime	V199	961	5.024	1	.025	.072
Depressants	depress	961	5.024	1	.025	.072

Age (categorical)	agecat	961	31.396	10	.000	.181
Metro vs. Non-Metro County	codichot	961	7.658	1	.006	.089
Geographic Region	geogreg	961	12.289	3	.006	.113
Geographic Division	geogdiv	961	30.704	8	.000	.179
Victim Age (categorical)	vicagecat	961	38.094	9	.000	.199
Victim Age Difference	vicagediff	961	85.555	65	.045	.298

Table 70. Officer-involved Domestic Violence Arrest Cases: Logistic Regression Model Predicting Job Loss ($N = 486$)

	<i>B</i>	<i>SE</i>	Wald	<i>p</i>	Exp(B)	95% CI for Exp(B)	
						<i>LL</i>	<i>UL</i>
Year of Arrest	0.420	0.067	38.770	< .001	1.521	1.333	1.736
Duty Status	1.848	0.714	6.704	.010	6.347	1.567	25.710
State	-0.018	0.007	5.742	.017	0.982	0.968	0.997
Rurality Continuum (categorical)	0.248	0.089	7.826	.005	1.282	1.077	1.525
Simple Assault	-0.711	0.228	9.712	.002	0.491	0.314	0.768
Suspended	-0.673	0.254	7.006	.008	0.510	0.310	0.840
Conviction	1.689	0.231	53.587	< .001	5.414	3.445	8.510
OIDV: Weapon: Other Body Parts (not hands or fist)	0.946	0.352	7.215	.007	2.576	1.291	5.138
28 U.S.C. §1441 Civil Case Removed to Federal Court	1.150	0.432	7.101	.008	3.159	1.356	7.360
- 2 Log Likelihood	525.053						
Model Chi-Square	146.577			<.001			
Cox & Snell R^2	.260						
Nagelkerke R^2	.348						
ROC R^2	.600						
AUC	.800						
						95% CI for AUC	
						<i>LL</i>	<i>UL</i>
						.762	.839

Table 71. Profit-motivated Police Crime Arrest Cases, 2005-2011: Arrested Officers and Employing Agencies (*N* = 1,591)

	<i>n</i>	(%)		<i>n</i>	(%)		<i>n</i>	(%)
Sex			Officer Duty Status			Agency Type		
Male	1,497	(94.1)	On-Duty	1,093	(68.7)	Primary State Police	62	(3.9)
Female	94	(5.9)	Off-Duty	498	(31.3)	Sheriff's Office	251	(15.8)
Age			Rank			County Police Dept.	66	(4.2)
19-23	24	(1.5)	Officer	1,132	(71.2)	Municipal Police Dept.	1,162	(73.0)
24-27	137	(8.6)	Detective	111	(7.0)	Special Police Dept.	42	(2.6)
28-31	207	(13.0)	Corporal	25	(1.6)	Constable	7	(0.4)
32-35	233	(14.6)	Sergeant	141	(8.9)	Tribal Police Dept.	1	(0.1)
36-39	244	(15.3)	Lieutenant	42	(2.6)	Regional Police Dept.	0	(0.0)
40-43	231	(14.5)	Captain	18	(1.1)	Full-Time Sworn Officers		
44-47	144	(9.1)	Major	5	(0.3)	0	7	(0.4)
48-51	90	(5.7)	Colonel	2	(0.1)	1	16	(1.0)
52-55	48	(3.0)	Deputy Chief	18	(1.1)	2-4	67	(4.2)
56 or older	62	(3.9)	Chief	97	(6.1)	5-9	77	(4.9)
Missing	171	(10.8)	Function			10-24	176	(11.1)
Years of Service			Patrol & Street Level	1,243	(78.1)	25-49	152	(9.6)
0-2	148	(9.3)	Line/Field Supervisor	208	(13.1)	50-99	167	(10.5)
3-5	197	(12.4)	Management	140	(8.8)	100-249	169	(10.6)
6-8	162	(10.2)	Region of United States			250-499	161	(10.1)
9-11	155	(9.7)	Northeastern States	362	(22.8)	500-999	104	(6.5)
12-14	126	(7.9)	Midwestern States	329	(20.7)	1,000 or more	495	(31.1)
15-17	104	(6.5)	Southern States	726	(45.6)	Part-Time Sworn Officers		
18-20	111	(7.0)	Western States	174	(10.9)	0	1,209	(76.)
21-23	55	(3.5)	Level of Rurality			1	46	(2.9)
24-26	25	(1.6)	Metropolitan County	1,312	(82.5)	2-4	104	(6.5)
27 or more years	43	(2.7)	Non-Metro County	279	(17.5)	5-9	111	(7.0)
Missing	465	(29.2)	Arresting Agency			10-24	94	(5.9)
Employing Agency	510	(32.1)	Employing Agency			25-49	19	(1.2)
Another Agency	1,081	(67.9)	Another Agency			50-99	6	(0.3)
						100-249	1	(0.1)
						250-499	1	(0.1)

Table 72. Most Serious Offense Charged in Profit-motivated Police Crime Arrest Cases, 2005-2011 (N = 1,591)

	<i>n</i>	(%)		<i>n</i>	(%)
Unclassified Theft / Larceny	255	(16.0)	Wire Fraud	9	(0.6)
False Pretenses / Swindle	199	(12.5)	Gambling: Operating / Promoting	9	(0.6)
Drug / Narcotic violation	189	(11.9)	Simple Assault	7	(0.4)
Robbery	103	(6.4)	Motor Vehicle Theft	7	(0.4)
Theft from Building	92	(5.8)	Credit Card Fraud / ATM Fraud	6	(0.4)
Extortion / Blackmail	85	(5.3)	Murder & Nonnegligent Manslaughter	5	(0.3)
Embezzlement	77	(4.8)	Assisting or Promoting Prostitution	4	(0.3)
Burglary / Breaking & Entering	72	(4.5)	Evidence: Destroying / Tampering	4	(0.3)
Bribery	56	(3.5)	Gambling: Betting / Wagering	3	(0.2)
All Other Offenses	49	(3.1)	Theft of Motor Vehicle Parts / Accessories	3	(0.2)
False Report / False Statement	46	(2.9)	Kidnapping / Abduction	2	(0.1)
Weapons Law violation	40	(2.5)	Unclassified Sex Crime	2	(0.1)
Counterfeiting / Forgery	39	(2.5)	Welfare Fraud	1	(0.1)
Stolen Property Offenses	38	(2.4)	Pocket-Picking	1	(0.1)
Shoplifting	31	(1.9)	Theft from a Coin-operated Machine	1	(0.1)
Official Misconduct / Oppression / Violation of Oath	29	(1.8)	Prostitution	1	(0.1)
Civil Rights violation	26	(1.6)	Forcible Sodomy	1	(0.1)
Intimidation	21	(1.3)	Forcible Fondling	1	(0.1)
Theft from Motor Vehicle	21	(1.3)	Bad Checks	1	(0.1)
Arson	16	(1.0)	Disorderly Conduct	1	(0.1)
Impersonation	14	(0.9)	Family Offenses, nonviolent	1	(0.1)
Obstruction of Justice	11	(0.7)	Liquor Law violation	1	(0.1)
Aggravated Assault	10	(0.6)	Wiretapping, illegal	1	(0.1)

Table 73. Victim Characteristics in Profit-motivated Police Crime Arrest Cases, 2005-2011 (*N* = 1,591)

	<i>n</i>	(%)	(Valid %)		<i>n</i>	(%)	(Valid %)
Victim's Sex				Victim's Relationship			
Female	71	(4.4)	(26.7)	Current Spouse	1	(0.1)	(0.3)
Male	195	(83.3)	(73.3)	Former Spouse	4	(0.3)	(1.1)
Missing	1,325	(16.7)		Current Girlfriend or Boyfriend	1	(0.1)	(0.3)
Victim's Age				Former Girlfriend or Boyfriend	6	(0.4)	(1.6)
Birth-11	0	(0.0)	(0.0)	Child or Stepchild	0	(0.0)	(0.0)
12-13	1	(0.1)	(2.2)	Some Other Relative	5	(0.3)	(1.3)
14-15	0	(0.0)	(0.0)	Unrelated Child	6	(0.4)	(1.6)
16-17	2	(0.1)	(4.3)	Stranger or Acquaintance	350	(21.9)	(93.8)
18-19	1	(0.1)	(2.2)	Missing	1,218	(76.5)	
20-24	9	(0.6)	(19.5)	Victim's Law Enforcement Status			
25-32	11	(0.7)	(24.0)	Victim is Not a Police Officer	358	(22.5)	(96.8)
33-41	9	(0.6)	(19.5)	Victim is a Police Officer	12	(0.8)	(3.2)
42 or older	13	(0.8)	(28.3)	Missing	1,221	(76.7)	
Missing	1,545	(97.0)		Victim Adult or Child			
				Adult	374	(23.5)	(98.2)
				Child	7	(0.4)	(1.8)
				Missing	1,210	(76.1)	

Table 74. Bivariate Associations of Conviction in Profit-motivated Police Crime Arrest Cases

Variable Label	Variable	<i>N</i>	χ^2	<i>df</i>	<i>p</i>	<i>V</i>
Year	V2	1,105	23.832	6	.001	.147
Age	V3	1,010	85.828	49	.001	.292
Years of Service	V4	799	62.423	39	.010	.280
Type of Agency	V9	1,105	14.237	6	.027	.114
State	V11	1,105	88.251	47	.000	.283
Part-Time Sworn Personnel (categorical)	V12	1,105	21.871	8	.005	.141
Urban to Rural Continuum Code	V13	1,105	43.579	8	.000	.199
Arresting Agency	V14	1,105	22.569	1	.000	.143
Burglary	V20	1,105	5.262	1	.022	.069
Drug / Narcotic violation	V23	1,105	28.447	1	.000	.160
Embezzlement	V25	1,105	7.204	1	.007	.081
Extortion / Blackmail	V26	1,105	5.654	1	.017	.072
Pocket-Picking	V40	1,105	4.790	1	.029	.066
Shoplifting	V42	1,105	7.668	1	.006	.083
Weapons Law violation	V63	1,105	5.992	1	.014	.074
Civil Rights violation	V65	1,105	5.402	1	.020	.070
Victim's Relationship to the Offender	V85	266	25.017	6	.000	.307
Organizational vs. Against Citizenry	V90	1,105	5.729	1	.017	.072
Drug-related Police Crime	V93	1,105	23.074	1	.000	.145
Violence-related Police Crime	V96	1,105	4.100	1	.043	.061
Officer was Reassigned	V102	1,105	18.365	1	.000	.129
Officer was Suspended	V104	1,105	22.939	1	.000	.144
Officer's Supervisor was Disciplined	V105	1,105	6.340	1	.012	.076
Officer's Chief is Under Scrutiny	V106	1,105	4.178	1	.041	.061
Family Violence	V126	1,105	9.353	1	.002	.092
Oxycodone	V133	1,105	5.048	1	.025	.068
Cocaine	V139	1,105	19.749	1	.000	.134
Marijuana	V148	1,105	4.436	1	.035	.063
OIDV: Weapon: Dept-issued Gun	V156	1,105	4.790	1	.029	.066
OIDV: Weapon: Hands / Fist	V164	1,105	4.790	1	.029	.066
OIDV: Weapon: Miscellaneous Objects	V166	1,105	4.790	1	.029	.066
OIDV: Weapon: Verbal Threats	V167	1,105	9.588	1	.002	.093
OIDV: Protection Order was Filed	V171	1,105	9.588	1	.002	.093
OIDV: Victim Injured, nonfatal	V173	1,105	14.395	1	.000	.114

18 U.S.C. §242 Criminal Defendant	V181	1,105	6.282	1	.012	.075
Drugs: Trafficking	V197	1,105	20.696	1	.000	.137
Drugs: Facilitation of Drug Trade	V201	1,105	11.065	1	.001	.100
Drugs: Shakedown from Car Stops	V206	1,105	6.252	1	.012	.075
Drugs: Shakedown from Off-Duty Robberies	V207	1,105	3.988	1	.046	.060
Drugs: Shakedown (aggregate)	V210	1,105	7.766	1	.005	.084
Lost Job	joblossb	1,105	82.094	1	.000	.273
Narcotics	narcotics	1,105	6.347	1	.012	.076
Stimulants	stimulant	1,105	18.068	1	.000	.128
Cannabis	cannabis	1,105	4.436	1	.035	.063
Age (categorical)	agecat	1,105	44.496	10	.000	.201
Geographic Region	geogreg	1,105	12.647	3	.005	.107
Geographic Division	geogdiv	1,105	16.063	8	.041	.121
Victim Age (categorical)	vicagecat	1,105	21.614	6	.001	.140
Victim Age Difference	vicagediff	1,105	39.147	21	.009	.188

Table 75. Profit-motivated Police Crime Arrest Cases: Logistic Regression Model Predicting Conviction ($N = 197$)

	<i>B</i>	<i>SE</i>	Wald	<i>p</i>	Exp(B)	95% CI for Exp(B)	
						<i>LL</i>	<i>UL</i>
Type of Agency	0.519	0.224	5.381	.020	1.681	1.084	2.606
State	0.070	0.020	12.566	< .001	1.073	1.032	1.115
Part-time Sworn Personnel (categorical)	-0.318	0.160	3.931	.047	0.728	0.532	0.996
Violence-related	1.666	0.732	5.177	.023	5.292	1.260	22.234
Officer's Chief is Under Scrutiny	-3.293	1.398	5.549	.018	0.037	0.002	0.575
Drugs: Shakedown / Theft from Off-duty Robbery	-4.517	2.035	4.927	.026	0.011	0.000	0.589
Drugs: Any Shakedown / Theft)	4.702	1.648	8.141	.004	110.177	4.358	2785.279
Job Lost	3.187	0.679	22.041	< .001	24.216	6.401	91.605
Victim Age Categorical	-0.357	0.123	8.439	.004	0.700	0.550	0.890
- 2 Log Likelihood	133.494						
Model Chi-Square	82.984			<.001			
Cox & Snell R^2	.344						
Nagelkerke R^2	.516					95% CI for AUC	
ROC R^2	.186					<i>LL</i>	<i>UL</i>
AUC	.593					.547	.639

Table 76. Bivariate Associations of Job Loss in Profit-motivated Police Crime Arrest Cases

Variable Label	Variable	<i>N</i>	χ^2	<i>df</i>	<i>p</i>	<i>V</i>
Year	V2	1,591	155.340	6	.000	.312
Years of Service	V4	1,126	56.457	39	.035	.224
Gender	V5	1,591	7.232	1	.007	.067
Rank	V7	1,591	23.219	9	.006	.121
Type of Agency	V9	1,591	13.075	6	.042	.091
Full-Time Sworn Personnel (categorical)	V10	1,591	33.267	10	.000	.145
State	V11	1,591	126.335	47	.000	.282
Urban to Rural Continuum	V13	1,591	21.745	8	.005	.117
Arresting Agency	V14	1,591	4.878	1	.027	.055
Arson	V15	1,591	5.204	1	.023	.057
Drug / Narcotic violation	V23	1,591	17.469	1	.000	.105
Credit Card / ATM Fraud	V28	1,591	5.860	1	.015	.061
Wire Fraud	V31	1,591	6.423	1	.011	.064
Gambling: Operating / Promoting	V33	1,591	6.619	1	.010	.065
Robbery	V52	1,591	4.630	1	.031	.054
Weapons Law violation	V63	1,591	7.182	1	.007	.067
Civil Rights violation	V65	1,591	15.304	1	.000	.098
Obstruction of Justice	V74	1,591	6.705	1	.010	.065
Victim is a Police Officer	V82	370	4.516	1	.034	.110
Internal versus Organizational	V91	1,591	14.997	1	.000	.097
Official Capacity	V92	1,591	7.175	1	.007	.067
Drug-related Police Crime	V93	1,591	16.389	1	.000	.101
Officer was Reassigned	V102	1,591	23.675	1	.000	.122
Officer was Suspended	V104	1,591	87.439	1	.000	.234
Officer's Supervisor was Disciplined	V105	1,591	15.083	1	.000	.097
Officer's Chief is Under Scrutiny	V106	1,591	4.366	1	.037	.052
Discussion of Agency Scandal	V107	1,591	9.010	1	.003	.075
Conviction	V109	1,105	82.094	1	.000	.273
Heroin	V129	1,591	8.764	1	.003	.074
Hydrocodone	V131	1,591	5.765	1	.016	.060
Oxycodone	V133	1,591	5.827	1	.016	.061
Other Narcotics	V135	1,591	4.499	1	.034	.053
28 U.S.C. §1441 Civil Rights Case Removed	V179	1,591	3.922	1	.048	.050

18 U.S.C. §242 Criminal Defendant	V181	1,591	20.538	1	.000	.114
Drugs: Using / Personal Use	V196	1,591	6.163	1	.013	.062
Drugs: Selling / Trafficking	V197	1,591	11.652	1	.001	.086
Drugs: Facilitation of Drug Trade	V201	1,591	9.870	1	.002	.079
Drugs: Shakedowns from Car Stops	V206	1,591	4.095	1	.043	.051
Drugs: Theft from Police Evidence Room	V208	1,591	5.085	1	.024	.057
Narcotics	narcotics	1,591	18.086	1	.000	.107
Depressants	depress	1,591	4.761	1	.029	.055
Age Categorical	agecat	1,591	49.034	10	.000	.176
Years of Service Categorical	yrsservcat	1,591	28.444	10	.002	.134
Metropolitan versus Nonmetro County	countydic	1,591	8.468	1	.004	.073
Geographic Region	geogreg	1,591	17.057	3	.001	.104
Geographic Division	geogdiv	1,591	33.167	8	.000	.144
Rank by Function	rankfunc	1,591	15.232	2	.000	.098

Table 77. Profit-motivated Police Crime Arrest Cases: Logistic Regression Model Predicting Job Loss ($N = 206$)

	<i>B</i>	<i>SE</i>	Wald	<i>p</i>	Exp(B)	95% CI for Exp(B)	
						<i>LL</i>	<i>UL</i>
Internal Crime Against the Organization	0.381	0.093	16.830	< .001	1.464	1.220	1.756
Official Capacity	2.302	0.781	8.692	.003	9.995	2.163	46.179
Discussion of an Agency Scandal or Cover Up	-2.597	0.824	9.922	.002	0.075	0.015	0.375
Conviction	2.404	0.633	14.413	< .001	11.070	3.200	38.301
Drugs: Selling / Dealing / Trafficking	3.839	1.235	9.666	.002	46.459	4.132	522.381
Geographic Division	0.528	0.152	12.104	.001	1.695	1.259	2.283
Obstruction of Justice	-2.741	1.073	6.530	.011	0.065	0.008	0.528
- 2 Log Likelihood	99.126						
Model Chi-Square	111.933			<.001			
Cox & Snell R^2	.419						
Nagelkerke R^2	.654					95% CI for AUC	
ROC R^2	.336					<i>LL</i>	<i>UL</i>
AUC	.668					.626	.711

Table 78. 200 Largest State & Local Law Enforcement Agencies in Study: Rates of Officers Arrested, 2005-2011 (Sorted by # Full-Time Sworn Personnel)

Agency	County	State	# of Full-Time Sworn Personnel	Per Agency	Per 1,000 Officers	Per 100,000 Population
New York City Police Department	New York	NY	36023	196	5.44	2.40
Chicago Police Department	Cook	IL	13354	83	6.22	1.60
Los Angeles Police Department	Los Angeles	CA	9727	30	3.08	0.31
Los Angeles County Sheriff's Office	Los Angeles	CA	9461	14	1.48	0.14
California Highway Patrol	Sacramento	CA	7202	13	1.81	0.03
Philadelphia Police Department	Philadelphia	PA	6624	66	9.96	4.33
Cook County Sheriff's Office	Cook	IL	5655	8	1.41	0.15
Houston Police Department	Harris	TX	5053	35	6.93	0.86
New York State Police	Albany	NY	4847	5	1.03	0.03
New York State Courts Officers	New York	NY	4500	1	0.22	0.01
Pennsylvania State Police	Dauphin	PA	4458	26	5.83	0.20
Washington Metropolitan Police Department	DC	DC	3742	29	7.75	4.82
Texas Department of Public Safety	Travis	TX	3529	6	1.70	0.02
Dallas Police Department	Dallas	TX	3389	39	11.51	1.65
Phoenix Police Department	Maricopa	AZ	3388	17	5.02	0.45
Miami-Dade (County) Police Department	Miami-Dade	FL	3093	25	8.08	1.00
New Jersey State Police	Mercer	NJ	3053	13	4.26	0.15
Baltimore Police Department	Baltimore City	MD	2990	55	18.39	8.86
Las Vegas Metro Police Department	Clark	NV	2942	8	2.72	0.41
Nassau County Police Department	Nassau	NY	2732	6	2.20	0.45
Suffolk County Police Department	Suffolk	NY	2622	6	2.29	0.40
Harris County Sheriff's Office	Harris	TX	2558	3	1.17	0.07
Massachusetts State Police	Middlesex	MA	2310	10	4.33	0.15
Detroit Police Department	Wayne	MI	2250	23	10.22	1.26
Boston Police Department	Suffolk	MA	2181	14	6.42	1.94
Riverside County Sheriff's Office	Riverside	CA	2147	11	5.12	0.50
Illinois State Police	Sangamon	IL	2105	10	4.75	0.08
San Antonio Police Department	Bexar	TX	2020	30	14.85	1.75
Milwaukee Police Department	Milwaukee	WI	1987	73	36.74	7.70
San Diego Police Department	San Diego	CA	1951	12	6.15	0.39
San Francisco Police Department	San Francisco	CA	1940	7	3.61	0.87
Honolulu (City & County) Police Department	Honolulu	HI	1934	26	13.44	2.73

Baltimore County Police Department	Baltimore	MD	1910	4	2.09	0.50
Columbus Police Department	Franklin	OH	1886	9	4.77	0.77
Virginia State Police	Chesterfield	VA	1873	3	1.60	0.04
North Carolina State Highway Patrol	Wake	NC	1827	8	4.38	0.08
San Bernardino County Sheriff's Office	San Bernardino	CA	1797	11	6.12	0.54
Orange County Sheriff-Coroner Department	Orange	CA	1794	14	7.80	0.47
Michigan State Police	Ingham	MI	1732	9	5.20	0.09
Atlanta Police Department	Fulton	GA	1719	22	12.80	2.39
Charlotte - Mecklenburg Police Department	Mecklenburg	NC	1672	20	11.96	2.17
Port Authority of New York & New Jersey Police	Hudson	NJ	1667	1	0.60	0.01
Jacksonville Sheriff's Office	Duval	FL	1662	12	7.22	1.39
Broward County Sheriff's Office	Broward	FL	1624	16	9.85	0.92
Cleveland Police Department	Cuyahoga	OH	1616	27	16.71	2.11
Florida Highway Patrol	Leon	FL	1606	14	8.72	0.07
Indianapolis Police	Marion	IN	1582	33	20.86	3.65
Prince George's County Police Department	Prince Georges	MD	1578	19	12.04	2.20
Ohio State Highway Patrol	Franklin	OH	1560	4	2.56	0.03
Memphis Police Department	Shelby	TN	1549	46	29.70	4.96
Denver Police Department	Denver	CO	1525	13	8.52	2.17
Austin Police Department	Travis	TX	1515	10	6.60	0.98
Fort Worth Police Department	Tarrant	TX	1489	20	13.43	1.11
Palm Beach County Sheriff's Office	Palm Beach	FL	1447	12	8.29	0.91
Maryland State Police	Baltimore	MD	1440	9	6.25	0.16
New Orleans Police Department	Orleans	LA	1425	63	44.21	18.32
Kansas City Police Department	Jackson	MO	1421	5	3.52	0.74
Fairfax County Police Department	Fairfax	VA	1419	7	4.93	0.65
Sacramento County Sheriff's Office	Sacramento	CA	1409	6	4.26	0.42
Orange County Sheriff's Office	Orange	FL	1398	16	11.44	1.40
San Jose Police Department	Santa Clara	CA	1382	9	6.51	0.51
St. Louis (city) Police Dept	St. Louis City	MO	1351	10	7.40	3.13
San Diego County Sheriff's Office	San Diego	CA	1322	7	5.30	0.23
Indiana State Police	Marion	IN	1315	4	3.04	0.06
Nashville Metro Police Department	Davidson	TN	1315	18	13.69	2.87
Newark Police	Essex	NJ	1310	8	6.11	1.02
Seattle Police Department	King	WA	1283	9	7.01	0.47
Arizona Department of Public Safety	Maricopa	AZ	1244	3	2.41	0.05

Connecticut State Police	Middlesex	CT	1227	4	3.26	0.11
Hillsborough County Sheriff's Office	Hillsborough	FL	1223	10	8.18	0.81
Louisiana State Police	E. Baton Rouge	LA	1215	2	1.65	0.04
Montgomery County Police Department	Montgomery	MD	1206	16	13.27	1.65
Louisville Metro Police Department	Jefferson	KY	1197	16	13.37	2.16
Washington State Patrol	Thurston	WA	1132	2	1.77	0.03
El Paso Police Department	El Paso	TX	1132	15	13.25	1.87
Miami Police Department	Miami-Dade	FL	1104	14	12.68	0.56
Cincinnati Police Department	Hamilton	OH	1082	10	9.24	1.25
DeKalb County Police Department	DeKalb	GA	1074	13	12.10	1.88
Wayne County Sheriff's Office	Wayne	MI	1062	1	0.94	0.05
Georgia Department of Public Safety	Fulton	GA	1048	1	0.95	0.01
Oklahoma City Police Department	Oklahoma	OK	1046	12	11.47	1.67
Tucson Police Department	Pima	AZ	1032	6	5.81	0.61
Albuquerque Police Department	Bernalillo	NM	1020	13	12.75	1.96
Tampa Police Department	Hillsborough	FL	980	3	3.06	0.24
Long Beach Police Department	Los Angeles	CA	968	4	4.13	0.04
South Carolina Highway Patrol	Richland	SC	967	10	10.34	0.22
Tennessee Department of Safety	Davidson	TN	942	4	4.25	0.06
Alameda County Sheriff's Office	Alameda	CA	928	2	2.16	0.13
Portland Police Bureau	Multnomah	OR	928	10	10.78	1.36
Minneapolis Police Department	Hennepin	MN	902	18	19.96	1.56
Jersey City Police	Hudson	NJ	900	12	13.33	1.89
Pittsburgh Police Department	Allegheny	PA	891	21	23.57	1.72
Kentucky State Police	Franklin	KY	882	3	3.40	0.07
Pinellas County Sheriff's Office	Pinellas	FL	863	8	9.27	0.87
Mesa Police Department	Maricopa	AZ	831	2	2.41	0.05
Fresno Police Department	Fresno	CA	828	7	8.45	0.75
Tulsa Police Department	Tulsa	OK	826	11	13.32	1.82
Oklahoma Department of Public Safety	Oklahoma	OK	825	5	6.06	0.13
Jefferson Parish Sheriff's Office	Jefferson	LA	825	12	14.55	2.77
Birmingham Police Department	Jefferson	AL	816	8	9.80	1.21
Virginia Beach Police Department	VA Beach City	VA	813	9	11.07	2.05
Buffalo Police Department	Erie	NY	793	4	5.04	0.44
St. Louis County Police Dept	St. Louis	MO	781	2	2.56	0.20
Oakland Police Department	Alameda	CA	773	3	3.88	0.20

Norfolk Police Department	Norfolk City	VA	772	14	18.13	5.77
Maricopa County Sheriff's Office	Maricopa	AZ	766	2	2.61	0.05
Alabama Department of Public Safety	Montgomery	AL	763	2	2.62	0.04
Orlando Police Department	Orange	FL	757	8	10.57	0.70
Ventura County Sheriff's Office	Ventura	CA	755	1	1.32	0.12
Richmond Police Department	Richmond City	VA	752	7	9.31	3.43
Omaha Police Dept	Douglas	NE	747	6	8.03	1.16
Colorado State Patrol	Jefferson	CO	742	4	5.39	0.08
Marion County Sheriff's Office	Marion	IN	740	7	9.46	0.77
Denver County Sheriff's Office	Denver	CO	739	5	6.77	0.83
King County Sheriff's Office	King	WA	721	5	6.93	0.26
Rochester Police Department	Monroe	NY	703	3	4.27	0.40
Raleigh Police Department	Wake	NC	702	8	11.40	0.89
Sacramento Police Department	Sacramento	CA	701	5	7.13	0.35
New York State Metro Transportation Auth. Police	New York	NY	694	2	2.88	0.02
Gwinnett County Police Department	Gwinnett	GA	682	4	5.87	0.50
Contra Costa County Sheriff's Office	Contra Costa	CA	679	1	1.47	0.10
Iowa Department of Public Safety	Polk	IA	669	2	2.99	0.07
Colorado Springs Police Department	El Paso	CO	668	5	7.49	0.80
Wichita Police Department	Sedgwick	KS	662	2	3.02	0.40
Delaware State Police	Kent	DE	658	3	4.56	0.33
Yonkers Police Department	Westchester	NY	641	2	3.12	0.21
Toledo Police Department	Lucas	OH	640	12	18.75	2.72
Anne Arundel County Police Department	Anne Arundel	MD	633	3	4.74	0.56
Baton Rouge Police Department	E. Baton Rouge	LA	630	6	9.52	1.36
Collier County Sheriff's Office	Collier	FL	628	6	9.55	1.87
Aurora Police Department	Arapahoe	CO	627	6	9.57	1.05
Florida Fish & Wildlife Conservation Commission	Leon	FL	626	4	6.39	0.02
Lee County Sheriff's Office	Lee	FL	621	7	11.27	1.13
Arlington Police Department	Tarrant	TX	610	3	4.92	0.17
Polk County Sheriff's Office	Polk	FL	600	13	21.67	2.16
St. Paul Police Department	Ramsey	MN	598	8	13.38	1.57
Mississippi Highway Safety Patrol	Hinds	MS	594	6	10.10	0.20
Greensboro Police Department	Guilford	NC	593	5	8.43	1.02
Calcasieu Parish Sheriff's Office	Calcasieu	LA	592	1	1.69	0.52
Cobb County Police Department	Cobb	GA	590	5	8.47	0.73

Pima County Sheriff's Dept.	Pima	AZ	554	1	1.81	0.10
Henrico County Division of Police	Henrico	VA	554	4	7.22	1.30
Prince William County Police Department	Prince William	VA	546	3	5.49	0.75
Savannah-Chatham Metropolitan Police Dept	Chatham	GA	534	6	11.24	2.26
Gwinnett County Sheriff's Office	Gwinnett	GA	531	3	5.65	0.37
Minnesota State Patrol	Ramsey	MN	530	4	7.55	0.08
Passaic County Sheriff's Office	Passaic	NJ	530	6	11.32	1.20
New Mexico State Police	Santa Fe	NM	528	13	24.62	0.63
Bexar County Sheriff's Office	Bexar	TX	526	5	9.51	0.29
Arkansas State Police	Pulaski	AR	525	2	3.81	0.07
Milwaukee County Sheriff's Office	Milwaukee	WI	524	7	13.36	0.74
Little Rock Police Department	Pulaski	AR	520	2	3.85	0.52
Fulton County Sheriff's Office	Fulton	GA	516	4	7.75	0.43
Shelby County Sheriff's Office	Shelby	TN	516	8	15.50	0.86
Mobile Police Department	Mobile	AL	515	4	7.77	0.97
Tulare County Sheriff's Office	Tulare	CA	513	3	5.85	0.68
Kern County Sheriff's Office	Kern	CA	512	11	21.48	1.31
Richland County Sheriff's Office	Richland	SC	512	3	5.86	0.78
Shreveport Police Department	Caddo	LA	511	12	23.48	4.71
St. Petersburg Police Department	Pinellas	FL	510	6	11.76	0.65
Winston-Salem Police Department	Forsyth	NC	508	3	5.91	0.86
Orleans Parish Sheriff's Office (Criminal Division)	Orleans	LA	505	4	7.92	1.16
Montgomery Police Department	Montgomery	AL	500	6	12.00	2.62
Fairfax County Sheriff's Office	Fairfax	VA	499	3	6.01	0.28
Brevard County Sheriff's Office	Brevard	FL	497	2	4.02	0.37
Paterson Police	Passaic	NJ	497	3	6.04	0.60
Monmouth County Sheriff's Office	Monmouth	NJ	494	1	2.02	0.16
Durham Police Department	Durham	NC	494	9	18.22	3.36
Nebraska State Patrol	Lancaster	NE	491	1	2.04	0.05
Syracuse Police Department	Onondaga	NY	489	3	6.13	0.64
Pasco County Sheriff's Office	Pasco	FL	485	4	8.25	0.86
District of Columbia Protective Services Police	DC	DC	484	1	2.07	0.17
Providence Police Department	Providence	RI	483	7	14.49	1.12
Fort Lauderdale Police Department	Broward	FL	482	6	12.45	0.34
Worcester Police Department	Worcester	MA	482	5	10.37	0.63
Jackson Police Department	Hinds	MS	480	9	18.75	3.67

Manatee County Sheriff's Office	Manatee	FL	476	4	8.40	1.24
Utah Department of Public Safety	Salt Lake	UT	475	2	4.21	0.07
Chesterfield County Police Department	Chesterfield	VA	475	1	2.11	0.32
Akron Police Department	Summit	OH	472	8	16.95	1.48
North Las Vegas Police Department	Clark	NV	471	2	4.25	0.10
Springfield Police Department	Hampden	MA	464	9	19.40	1.94
Fresno County Sheriff's Office	Fresno	CA	461	1	2.17	0.11
Knox County Sheriff's Office	Knox	TN	456	1	2.19	0.23
Maryland Transportation Authority Police	Baltimore	MD	456	1	2.19	0.02
Franklin County Sheriff's Office	Franklin	OH	455	2	4.40	0.17
El Paso County Sheriff's Office	El Paso	CO	454	1	2.20	0.16
Dane County Sheriff's Office	Dane	WI	454	2	4.41	0.41
Santa Clara County Sheriff's Office	Santa Clara	CA	450	1	2.22	0.06
Volusia County Sheriff's Office	Volusia	FL	450	4	8.89	0.81
School District of Philadelphia Police	Philadelphia	PA	450	1	2.22	0.07
Richmond County Sheriff's Office	Richmond	GA	449	5	11.14	2.49
Dallas County Sheriff's Office	Dallas	TX	449	1	2.23	0.04
Loudoun County Sheriff's Office	Loudoun	VA	448	2	4.46	0.64
Corpus Christi Police Department	Nueces	TX	448	3	6.70	0.88
Fort Wayne Police	Allen	IN	447	4	8.95	1.13
Will County Sheriff's Office	Will	IL	445	1	2.25	0.15
Leon County Sheriff's Office	Leon	FL	443	3	6.77	1.09
Washington Metro Area Transit Auth. Police	DC	DC	442	2	4.52	0.33
Madison Police Department	Dane	WI	437	1	2.29	0.20

Table 79. Nonmetropolitan State & Local Law Enforcement Agencies in Study: Rates of Officers Arrested, 2005-2011 (Sorted Alphabetically)

Agency	County	State	# of Full-Time Sworn Personnel	Per Agency	Per 1,000 Officers	Per 100,000 Population
Accomack County Sheriff's Office	Accomack	VA	27	1	37.04	3.02
Ada Police Department	Pontotoc	OK	42	1	23.81	2.67
Alamogordo Department of Public Safety	Otero	NM	71	1	14.08	1.57
Albert Lea Police Department	Freeborn	MN	29	1	34.48	3.20
Algood Police Department	Putnam	TN	11	1	90.91	1.38
Alice Police Department	Jim Wells	TX	37	1	27.03	2.45
Allegan County Sheriff's Office	Allegan	MI	59	1	16.95	0.90
Allendale Police Department	Allendale	SC	10	2	200.00	19.20
Allenstown Police Department	Merrimack	NH	10	1	100.00	0.68
Alma Police Department	Bacon	GA	10	1	100.00	9.01
Andalusia Police Dept.	Covington	AL	30	1	33.33	2.65
Andrews Police Department	Georgetown	SC	9	1	111.11	1.66
Appalachian State University Police Dept	Watauga	NC	25	1	40.00	1.96
Appling County Sheriff's Office	Appling	GA	14	1	71.43	5.48
Arcade Police Department	Jackson	GA	9	1	111.11	1.65
Aspen Police Department	Pitkin	CO	23	2	86.96	11.66
Assumption Parish Sheriff's Office	Assumption	LA	50	2	40.00	8.54
Athena Police Department	Umatilla	OR	2	1	500.00	1.32
Atwater Police Department	Kandiyohi	MN	1	1	1000.00	2.37
Auburn Police Department	Cayuga	NY	70	1	14.29	1.25
Austin Police Department	Mower	MN	31	1	32.26	2.55
Bainbridge Police Department	Decatur	GA	40	2	50.00	7.18
Barre Police Department	Washington	VT	18	1	55.56	1.68
Bartlesville Police Department	Washington	OK	54	4	74.07	7.85
Baxter County Sheriff's Office	Baxter	AR	32	1	31.25	2.41
Beardstown Police Dept	Cass	IL	9	1	111.11	7.33
Beeville Police Department	Bee	TX	23	1	43.48	3.14
Belle Police Department	Maries	MO	3	1	333.33	10.90
Belpre Police Department	Washington	OH	9	1	111.11	1.62
Bennettsville Police Department	Marlboro	SC	36	1	27.78	3.46
Benzie County Sheriff's Office	Benzie	MI	13	1	76.92	5.71
Berea Police Department	Madison	KY	30	1	33.33	1.21

Berlin Borough Police Department	Somerset	PA	1	1	1000.00	1.29
Berlin Heights Police Department	Erie	OH	1	1	1000.00	1.30
Big Horn County Sheriff's Office	Big Horn	MT	8	1	125.00	7.77
Big Spring Police Department	Howard	TX	40	1	25.00	2.86
Bingen-White Salmon Police Department	Klickitat	WA	6	1	166.67	4.92
Birchwood Police Department	Washburn	WI	2	1	500.00	6.28
Bishopville Police Department	Lee	SC	16	1	62.50	5.20
Bismarck Police Department	St. Francois	MO	3	1	333.33	1.53
Black Mountain Police Department	Buncombe	NC	18	1	55.56	2.22
Black River Falls Police Department	Jackson	WI	7	1	142.86	4.89
Blackford County Sheriff's Office	Blackford	IN	8	1	125.00	7.83
Bloomville Police Department	Seneca	OH	0	1		1.76
Blountstown Police Dept.	Calhoun	FL	8	1	125.00	6.84
Blue Lake Police Department	Humboldt	CA	4	1	250.00	0.74
Bluefield Police Department	Mercer	WV	21	1	47.62	1.61
Bogalusa Police Department	Washington	LA	37	1	27.03	2.12
Bolivar County Sheriff's Office	Bolivar	MS	18	1	55.56	2.93
Bolivar Police Department	Hardeman	TN	21	1	47.62	3.67
Boone Police Department	Watauga	NC	38	1	26.32	1.96
Boswell Police Department	Choctaw	OK	2	1	500.00	6.58
Bowman Police Department	Orangeburg	SC	3	3	1000.00	3.24
Braselton Police Department	Jackson	GA	12	1	83.33	1.65
Bridgeport Police Department	Jackson	AL	6	1	166.67	1.88
Brownwood Police Department	Brown	TX	38	2	52.63	5.25
Bunkie Police Department	Avoyelles	LA	12	1	83.33	2.38
Burr Oak Police Department	St. Joseph	MI	1	1	1000.00	1.63
Butler County Sheriff's Office	Butler	AL	9	3	333.33	14.32
Butler Township Police Department	Schuykill	PA	4	1	250.00	0.67
Butte - Silver Bow County Sheriff's Office	Silver Bow	MT	45	2	44.44	5.85
Byron Police Dept	Ogle	IL	7	1	142.86	1.87
BYU-Idaho Police Department	Madison	ID	10	1	100.00	2.66
Caddo Police Department	Bryan	OK	3	1	333.33	2.36
Calhoun County Sheriff's Office	Calhoun	FL	18	1	55.56	6.84
Calhoun Police Department	Gordon	GA	44	1	22.73	1.81
Campbell County Sheriff's Office	Campbell	WY	58	1	17.24	2.17
Canton Police Dept	Fulton	IL	23	1	43.48	2.70

Canton Village Police Department	St. Lawrence	NY	8	1	125.00	0.89
Caribou Police Department	Aroostook	ME	14	1	71.43	1.39
Carlisle Police Department	Nicholas	KY	5	1	200.00	14.02
Carter County Sheriff's Office	Carter	MO	3	2	666.67	31.92
Caruthersville Police Department	Pemiscot	MO	21	2	95.24	10.93
Central Michigan University Police Department	Isabella	MI	21	1	47.62	1.42
Chaffee Police Department	Scott	MO	5	1	200.00	2.55
Chandler Police Department	Henderson	TX	8	1	125.00	1.27
Cherokee County Sheriff's Office	Cherokee	SC	48	2	41.67	3.61
Cherokee Police Department	Alfalfa	OK	2	1	500.00	17.72
Chesterfield County Sheriff's Office	Chesterfield	SC	41	1	24.39	2.14
Chilhowie Police Department	Smyth	VA	6	4	666.67	12.42
Chillicothe Police Department	Ross	OH	47	1	21.28	1.28
Clarksdale Police Department	Coahoma	MS	35	1	28.57	3.82
Clay County Sheriff's Office	Clay	AR	7	1	142.86	6.22
Clayton County Sheriff's Office	Clayton	IA	12	1	83.33	5.52
Clearlake Police Department	Lake	CA	21	1	47.62	1.55
Clewiston Police Department	Hendry	FL	20	2	100.00	5.11
Clovis Police Department	Curry	NM	53	3	56.60	6.20
Clyde Police Department	Sandusky	OH	14	1	71.43	1.64
Cochran Police Department	Bleckley	GA	14	3	214.29	22.97
Coeburn Police Department	Wise	VA	7	1	142.86	2.41
Columbiana County Sheriff's Office	Columbiana	OH	22	2	90.91	1.85
Columbus Police Department	Lowndes	MS	62	1	16.13	1.67
Columbus Police Department	Colorado	TX	10	1	100.00	4.79
Columbus Police Department	Polk	NC	6	1	166.67	4.88
Columbus Police Department	Luna	NM	4	1	250.00	3.98
Commerce Police Department	Jackson	GA	24	1	41.67	1.65
Commerce Police Department	Ottawa	OK	5	1	200.00	3.14
Concord Police Department	Merrimack	NH	77	1	12.99	0.68
Conneaut Police Department	Ashtabula	OH	19	1	52.63	0.99
Cookeville Police Department	Putnam	TN	70	2	28.57	2.77
Cooter Police Department	Pemiscot	MO	1	1	1000.00	5.47
Corbin Police Department	Whitley	KY	19	1	52.63	2.81
Corinth Police Department	Alcorn	MS	39	1	25.64	2.70
Cortland Police Department	Cortland	NY	44	1	22.73	2.03

Craig Police Department	Moffat	CO	22	1	45.45	7.25
Crescent City Police Department	Putnam	FL	5	1	200.00	1.34
Creston Police Department	Union	IA	10	2	200.00	15.96
Cross County Sheriff's Office	Cross	AR	17	1	58.82	5.60
Crossett Police Department	Ashley	AR	15	1	66.67	4.58
Crystal City Police Department	Zavala	TX	11	4	363.64	34.26
Cullman County Sheriff's Office	Cullman	AL	78	1	12.82	1.24
Custer County Sheriff's Office	Custer	OK	12	1	83.33	3.64
Dale County Sheriff's Office	Dale	AL	0	1		1.99
Danville (City) Sheriff's Office	Danville City	VA	69	3	43.48	6.97
Danville Police Department	Pittsylvania	VA	126	1	7.94	1.57
Daviess County Sheriff's Office	Daviess	IN	19	1	52.63	3.16
DeKalb County Sheriff's Office	DeKalb	AL	34	1	29.41	1.41
Del Norte County Sheriff's Office	Del Norte	CA	30	2	66.67	6.99
Del Rio Police Department	Val Verde	TX	65	1	15.38	2.05
Delavan Police Department	Walworth	WI	19	1	52.63	0.98
Delhi Police Department	Richland	LA	5	1	200.00	4.83
Delhi Village Police Department	Delaware	NY	4	1	250.00	2.08
Demopolis Police Department	Marengo	AL	19	1	52.63	4.76
Denton Police Department	Caroline	MD	13	1	76.92	3.02
Deridder Police Department	Beauregard	LA	24	1	41.67	2.80
Dewitt Police Department	Clinton	IA	10	1	100.00	2.04
Dillon Police Department	Dillon	SC	25	1	40.00	3.12
Dillon Police Department	Summit	CO	9	1	111.11	3.57
Dixon Police Department	Pulaski	MO	5	1	200.00	1.91
Dodge City Police Department	Ford	KS	49	1	20.41	2.95
Douglas County Sheriff's Office	Douglas	NV	100	1	10.00	2.13
Dunn Police Department	Harnett	NC	37	1	27.03	0.87
Durand Police Department	Shiawassee	MI	5	1	200.00	1.42
Durango Police Department	La Plata	CO	50	1	20.00	1.95
Durant Police Department	Bryan	OK	36	1	27.78	2.36
Duval County Sheriff's Office	Duval	TX	18	1	55.56	8.49
Earlville Police Dept	La Salle	IL	3	1	333.33	0.88
East Brewton Police Department	Escambia	AL	6	1	166.67	2.61
Eastman Police Department	Dodge	GA	11	1	90.91	4.59
Eatonton Police Department	Putnam	GA	16	1	62.50	4.71

Edenton Police Department	Chowan	NC	12	3	250.00	20.28
Elgin Police Department	Grant	ND	1	1	1000.00	41.77
Elkin Police Department	Surry	NC	17	1	58.82	1.36
Elko County Sheriff's Office	Elko	NV	57	1	17.54	2.05
Elmore Police Department	Ottawa	OH	4	1	250.00	2.41
Emery County Sheriff's Office	Emery	UT	26	2	76.92	18.22
Emmet County Sheriff's Office	Emmet	MI	23	1	43.48	3.06
Ephrata Police Department	Grant	WA	15	1	66.67	1.12
Errol Police Department	Coos	NH	0	1		3.03
Estill County Sheriff's Office	Estill	KY	5	1	200.00	6.82
Eunice Police Department	St. Landry	LA	32	5	156.25	6.00
Eunice Police Department	Lea	NM	8	1	125.00	1.54
Eureka Police Department	Humboldt	CA	46	1	21.74	0.74
Fair Bluff Police Department	Columbus	NC	3	1	333.33	1.72
Fairfax Police Department	Allendale	SC	6	1	166.67	9.60
Fairland Police Department	Ottawa	OK	4	1	250.00	3.14
Fairmont Police Department	Robeson	NC	13	1	76.92	0.75
Farmville Police Department	Prince Edward	VA	27	1	37.04	4.28
Fayette County Sheriff's Office	Fayette	OH	22	3	136.36	10.33
Fayette Police Department	Fayette	AL	12	1	83.33	5.80
Ferriday Police Department	Concordia	LA	10	1	100.00	4.80
Ferry County Sheriff's Office	Ferry	WA	10	1	100.00	13.24
Flemingsburg Police Department	Fleming	KY	7	1	142.86	6.97
Florala Police Department	Covington	AL	6	1	166.67	2.65
Floyd County Sheriff's Office	Floyd	IA	11	1	90.91	6.13
Forest City Police Department	Winnebago	IA	9	1	111.11	9.20
Forks Police Department	Clallam	WA	9	1	111.11	1.40
Fort Dodge Police Department	Webster	IA	37	1	27.03	2.63
Fort Gibson Police Department	Muskogee	OK	11	1	90.91	1.41
Fort Madison Police Department	Lee	IA	17	1	58.82	2.79
Fort Payne Police Department	DeKalb	AL	34	1	29.41	1.41
Foster Township Police Department	McKean	PA	4	1	250.00	2.30
Frankfort Police Department	Franklin	KY	65	1	15.38	2.03
Franklin County Sheriff's Office	Franklin	IN	12	1	83.33	4.33
Franklin Police Dept	Franklin	NE	2	1	500.00	31.01
Freedom Police Department	Carroll	NH	3	1	333.33	2.09

Fremont County Sheriff's Office	Fremont	IA	7	1	142.86	13.44
Frisco Police Department	Summit	CO	13	1	76.92	3.57
Fryeburg Police Department	Oxford	ME	5	1	200.00	1.73
Gaffney Police Department	Cherokee	SC	37	2	54.05	3.61
Gage County Sheriff's Office	Gage	NE	12	1	83.33	4.48
Galesburg Police Dept	Knox	IL	53	1	18.87	1.89
Gallatin County Sheriff's Office	Gallatin	IL	3	1	333.33	17.89
Gallup Police Department	McKinley	NM	62	1	16.13	1.40
Gatlinburg Police Department	Sevier	TN	45	1	22.22	1.11
Geneva Township Police Department	Walworth	WI	6	1	166.67	0.98
Georgetown County Sheriff's Office	Georgetown	SC	78	1	12.82	1.66
Gillette Police Department	Campbell	WY	45	1	22.22	2.17
Glendive Police Department	Dawson	MT	9	1	111.11	11.15
Gold Beach Police Department	Curry	OR	4	1	250.00	4.47
Graham County Sheriff's Office	Graham	AZ	23	1	43.48	2.69
Grambling State University Police Dept.	Lincoln	LA	9	2	222.22	4.28
Grand Rapids Police Department	Wood	WI	5	1	200.00	1.34
Grand Traverse County Sheriff's Office	Grand Traverse	MI	64	2	31.25	2.30
Grant County Sheriff's Office	Grant	IN	45	1	22.22	1.43
Grant County Sheriff's Office	Grant	OK	5	1	200.00	22.09
Grants Police Department	Cibola	NM	14	1	71.43	3.67
Great Bend Police Department	Barton	KS	30	1	33.33	3.61
Greenbrier County Sheriff's Office	Greenbrier	WV	30	1	33.33	2.82
Greene County Sheriff's Office	Greene	AR	15	1	66.67	2.38
Greene County Sheriff's Office	Greene	AL	11	1	90.91	11.06
Greensburg Police	Decatur	IN	18	1	55.56	3.89
Greenville Police Department	Washington	MS	96	2	20.83	3.91
Griggs County Sheriff's Office	Griggs	ND	3	1	333.33	41.32
Guadalupe County Sheriff's Office	Guadalupe	NM	3	1	333.33	21.34
Halifax County Sheriff's Office	Halifax	VA	29	1	34.48	2.76
Hamburg Police Department	Fremont	IA	1	1	1000.00	13.44
Hampton County Sheriff's Office	Hampton	SC	26	1	38.46	4.74
Hanceville Police Department	Cullman	AL	9	1	111.11	1.24
Hannahville Tribal Police Department	Menominee	MI	11	1	90.91	4.16
Hardeman County Sheriff's Office	Hardeman	TN	22	1	45.45	3.67
Harrison County Sheriff's Office	Harrison	TX	45	1	22.22	1.52

Harrodsburg Police Department	Mercer	KY	16	1	62.50	4.69
Haskell Police Department	Muskogee	OK	5	1	200.00	1.41
Haskell Police Department	Haskell	TX	3	1	333.33	16.95
Hastings Police Dept	Adams	NE	36	2	55.56	6.38
Haynesville Police Dept	Claiborne	LA	7	1	142.86	5.82
Haywood County Sheriff's Office	Haywood	TN	22	1	45.45	5.32
Hegins Township Police Department	Schuylkill	PA	2	1	500.00	0.67
Helen Police Department	White	GA	10	1	100.00	3.68
Helena/West Helena Police Department	Phillips	AR	30	4	133.33	18.38
Hemingway Police Department	Williamsburg	SC	4	1	250.00	2.91
Hempstead County Sheriff's Office	Hempstead	AR	13	1	76.92	4.42
Hendry County Sheriff's Office	Hendry	FL	67	1	14.93	2.55
Hennessey Police Department	Kingfisher	OK	3	1	333.33	6.65
Henry County Sheriff's Office	Henry	VA	112	14	125.00	25.85
Hermann Police Department	Gasconade	MO	7	1	142.86	6.57
Hockley County Sheriff's Office	Hockley	TX	11	2	181.82	8.72
Holly Hill Police Department	Orangeburg	SC	7	1	142.86	1.08
Holmes County Sheriff's Office	Holmes	OH	33	1	30.30	2.36
Holt County Sheriff's Office	Holt	NE	5	1	200.00	9.58
Homer City Borough Police Department	Indiana	PA	2	1	500.00	1.13
Hooksett Police Department	Merrimack	NH	28	1	35.71	0.68
Hornell Police Department	Steuben	NY	22	1	45.45	1.01
Humboldt Police Department	Gibson	TN	26	2	76.92	4.03
Hunter Police Department	Greene	NY	2	1	500.00	2.03
Huron Police Department	Beadle	SD	24	1	41.67	5.75
Indiana Borough Police Department	Indiana	PA	22	1	45.45	1.13
Inman Police Department	McPherson	KS	2	1	500.00	3.43
Ishpeming Police Department	Marquette	MI	10	1	100.00	1.49
Jackson County Sheriff's Office	Jackson	FL	61	1	16.39	2.01
Jackson County Sheriff's Office	Jackson	TN	14	3	214.29	25.78
Jaffrey Police Department	Cheshire	NH	10	1	100.00	1.30
Jamestown Police Department	Chautauqua	NY	62	2	32.26	1.48
Jennings Police Department	Jefferson Davis	LA	24	1	41.67	3.17
Jim Wells County Sheriff's Office	Jim Wells	TX	27	1	37.04	2.45
Juneau County Sheriff's Office	Juneau	WI	45	1	22.22	3.75
Juneau Police Dept.	Juneau	AK	44	1	22.73	3.20

Kahoka Police Department	Clark	MO	3	1	333.33	6.58
Kalispell Police Department	Flathead	MT	36	1	27.78	1.10
Kauai (County) Police Department	Kauai	HI	125	3	24.00	4.47
Kaw Nation Tribal Police	Kay	OK	6	1	166.67	2.15
Kendallville Police	Noble	IN	18	1	55.56	2.10
Kenton Police Department	Obion	TN	5	1	200.00	3.14
Keokuk County Sheriff's Office	Keokuk	IA	4	1	250.00	9.51
Kermit Police Department	Winkler	TX	10	1	100.00	14.06
Kerrville Police Department	Kerr	TX	51	1	19.61	2.02
Ketchikan Police Dept.	Ketchikan Gateway	AK	22	1	45.45	7.42
Kingfisher County Sheriff's Office	Kingfisher	OK	8	1	125.00	6.65
Kings Mountain Police Department	Cleveland	NC	30	2	66.67	2.04
Kingsland Police Dept	Camden	GA	43	1	23.26	1.98
Kingsville Police Department	Kleberg	TX	45	1	22.22	3.12
Kitty Hawk Police Department	Dare	NC	17	1	58.82	2.95
Klamath Falls Police Department	Klamath	OR	39	1	25.64	1.51
La Salle County Sheriff's Office	La Salle	IL	36	1	27.78	0.88
La Salle County Sheriff's Office	La Salle	TX	10	3	300.00	43.57
LaGrange Police Department	Troup	GA	83	1	12.05	1.49
Lake County Sheriff's Office	Lake	CA	61	2	32.79	3.09
Lake County Sheriff's Office	Lake	CO	9	2	222.22	27.36
Lake County Sheriff's Office	Lake	SD	5	1	200.00	8.93
Lakeport Police Department	Lake	CA	12	1	83.33	1.55
Lamesa Police Department	Dawson	TX	16	1	62.50	7.23
Lamoure Police Department	LaMoure	ND	1	1	1000.00	24.16
Lancaster Police Department	Garrard	KY	10	1	100.00	5.91
Lander University Public Safety	Greenwood	SC	10	1	100.00	1.44
Las Vegas Police Department	San Miguel	NM	27	1	37.04	3.40
Lawrence County Sheriff's Office	Lawrence	IN	25	1	40.00	2.17
Lawrence Township Police Department	Clearfield	PA	9	1	111.11	1.22
Lebanon Police Department	Grafton	NH	35	1	28.57	1.12
Lebanon Police Department	Laclede	MO	30	1	33.33	2.81
Lee County Sheriff's Office	Lee	NC	47	1	21.28	1.73
Lee County Sheriff's Office	Lee	SC	28	1	35.71	5.20
Leesville Police Department	Vernon	LA	28	1	35.71	1.91
Leland Police Department	Washington	MS	18	1	55.56	1.96

Lenawee County Sheriff's Office	Lenawee	MI	44	1	22.73	1.00
Lenoir County Sheriff's Office	Lenoir	NC	58	2	34.48	3.36
Level Plains Police Department	Dale	AL	5	1	200.00	1.99
Lewis County Sheriff's Office	Lewis	MO	5	1	200.00	9.79
Lincoln County Sheriff's Office	Lincoln	OR	65	1	15.38	2.17
Lincoln Parish Sheriff's Office	Lincoln	LA	46	1	21.74	2.14
Lockhart Police Department	Covington	AL	1	1	1000.00	2.65
Lumberton Police Department	Robeson	NC	73	1	13.70	0.75
Luna County Sheriff's Office	Luna	NM	30	1	33.33	3.98
Madill Police Department	Marshall	OK	12	1	83.33	6.31
Madison County Sheriff's Office	Madison	MO	8	1	125.00	8.18
Mahanoy City Borough Police Department	Schuylkill	PA	4	1	250.00	0.67
Malakoff Police Department	Henderson	TX	4	1	250.00	1.27
Manitowoc Police Department	Manitowoc	WI	64	2	31.25	2.46
Marble Falls Police Department	Burnet	TX	27	1	37.04	2.34
Marble Head Police Department	Ottawa	OH	4	1	250.00	2.41
Marion County Sheriff's Office	Marion	WV	27	1	37.04	1.77
Marion Police Department	Marion	SC	24	1	41.67	3.02
Marion Police Department	Smyth	VA	18	1	55.56	3.10
Marion Township Police Department	Waushara	WI	1	1	1000.00	4.08
Marksville Police Department	Avoyelles	LA	20	1	50.00	2.38
Marlboro County Sheriff's Office	Marlboro	SC	25	2	80.00	6.91
Marlow Police Department	Stephens	OK	10	1	100.00	2.22
Marshallville Police Dept.	Macon	GA	4	1	250.00	6.78
Martin County Sheriff's Office	Martin	NC	34	1	29.41	4.08
Marvell Police Department	Phillips	AR	3	1	333.33	4.60
Mason City Police Department	Cerro Gordo	IA	46	1	21.74	2.26
Mason County Sheriff's Office	Mason	WV	21	3	142.86	10.98
McArthur Police Department	Vinton	OH	4	1	250.00	7.44
McDowell County Sheriff's Office	McDowell	NC	40	1	25.00	2.22
McDowell County Sheriff's Office	McDowell	WV	15	1	66.67	4.52
McIntosh County Sheriff's Office	McIntosh	OK	17	2	117.65	9.88
McKinley County Sheriff's Office	McKinley	NM	35	1	28.57	1.40
Medina Police Department	Gibson	TN	11	1	90.91	2.01
Meigs Police Department	Thomas	GA	3	1	333.33	2.24
Meridian Police Department	Lauderdale	MS	99	3	30.30	3.74

Meyersdale Borough Police Department	Somerset	PA	2	1	500.00	1.29
Miami Police Department	Ottawa	OK	30	1	33.33	3.14
Middlesex County Sheriff's Office	Middlesex	VA	17	1	58.82	9.12
Middletown Police	Henry	IN	5	1	200.00	2.02
Miller County Sheriff's Office	Miller	MO	16	1	62.50	4.04
Millersburg Police Department	Holmes	OH	10	1	100.00	2.36
Mineral Wells Police Department	Palo Pinto	TX	30	2	66.67	7.11
Minocqua Police Department	Oneida	WI	9	1	111.11	2.78
Missouri University of Science & Tech Police Dept	Phelps	MO	11	1	90.91	2.21
Moab Police Department	Grand	UT	15	1	66.67	10.84
Moberly Police Department	Randolph	MO	32	1	31.25	3.93
Monroe County Sheriff's Office	Monroe	FL	189	3	15.87	4.10
Monroe County Sheriff's Office	Monroe	WI	23	1	43.48	2.24
Monroeville Police Department	Huron	OH	4	1	250.00	1.68
Montague County Sheriff's Office	Montague	TX	10	1	100.00	5.07
Montezuma Police Department	Macon	GA	11	2	181.82	13.57
Monticello Police	White	IN	12	1	83.33	4.06
Montpelier Police Department	Bear Lake	ID	5	1	200.00	16.71
Mora County Sheriff's Office	Mora	NM	5	1	200.00	20.49
Morrow County Sheriff's Office	Morrow	OR	14	1	71.43	8.95
Mounds Police Dept	Pulaski	IL	1	2	2000.00	32.46
Mount Airy Police Department	Surry	NC	38	1	26.32	1.36
Mount Pleasant Police Department	Titus	TX	29	1	34.48	3.09
Murphy Police Department	Cherokee	NC	7	1	142.86	3.64
Murray Police Department	Calloway	KY	31	1	32.26	2.69
Muscatine Police Department	Muscatine	IA	39	1	25.64	2.34
Muskogee County Sheriff's Office	Muskogee	OK	37	1	27.03	1.41
Muskogee Police Department	Muskogee	OK	90	4	44.44	5.63
Nashville Police Department	Berrien	GA	15	1	66.67	5.19
Natchez Police Dept.	Adams	MS	48	4	83.33	12.39
Natchitoches Parish Sheriff's Office	Natchitoches	LA	45	1	22.22	2.53
Navajo Nation Tribal Dept of Law Enforcement	Apache	AZ	393	3	7.63	4.19
Nebraska City Police Dept	Otoe	NE	15	2	133.33	12.71
New Athens Police Department	Harrison	OH	0	1		6.30
New Castle (city) Police Department	Lawrence	PA	35	1	28.57	1.10
New Castle Police	Henry	IN	35	1	28.57	2.02

New Castle Police Department	Garfield	CO	7	1	142.86	1.77
New Lisbon Police Department	Juneau	WI	4	1	250.00	3.75
New Martinsville Police Department	Wetzel	WV	10	1	100.00	6.03
New Milford Police Department	Litchfield	CT	46	1	21.74	0.53
New York City Dept of Env. Protection Police	Westchester	NY	168	1	5.95	1.29
Newaygo County Sheriff's Office	Newaygo	MI	25	1	40.00	2.06
Newbury Police Department	Merrimack	NH	3	1	333.33	0.68
Newport Police Department	Sullivan	NH	14	1	71.43	2.29
Nicholas County Sheriff's Office	Nicholas	KY	1	1	1000.00	14.02
Nogales Police Department	Santa Cruz	AZ	60	2	33.33	4.22
North Kingsville Police Department	Ashtabula	OH	5	1	200.00	0.99
Norton Police Department	Norton	KS	6	1	166.67	17.63
Norwich Police Department	Chenango	NY	19	1	52.63	1.98
Nye County Sheriff's Office	Nye	NV	108	3	27.78	6.83
Oakdale Police Department	Allen	LA	20	1	50.00	3.88
Oakwood Police Department	Paulding	OH	1	1	1000.00	5.10
Ocean Shores Police Department	Grays Harbor	WA	14	1	71.43	1.37
Ogdensburg Police Department	St. Lawrence	NY	25	1	40.00	0.89
Oglesby Police Dept	La Salle	IL	8	1	125.00	0.88
Oglethorpe Police Department	Macon	GA	5	1	200.00	6.78
Okanogan County Sheriff's Office	Okanogan	WA	30	1	33.33	2.43
Olean Police Department	Cattaraugus	NY	32	1	31.25	1.25
Olney Police Department	Young	TX	5	1	200.00	5.39
Onley Police Department	Accomack	VA	4	1	250.00	3.02
Ontario Police Department	Malheur	OR	22	1	45.45	3.19
Opelousas Police Department	St. Landry	LA	58	1	17.24	1.20
Orangeburg County Sheriff's Office	Orangeburg	SC	92	1	10.87	1.08
Orangeburg Public Safety	Orangeburg	SC	72	3	41.67	3.24
Oregon County Sheriff's Office	Oregon	MO	5	2	400.00	18.38
Osceola County Sheriff's Office	Osceola	MI	18	1	55.56	4.25
Osceola Police Department	Clarke	IA	9	1	111.11	10.77
Otero County Sheriff's Office	Otero	NM	30	1	33.33	1.57
Page County Sheriff's Office	Page	VA	49	1	20.41	4.16
Palatka Police Department	Putnam	FL	37	1	27.03	1.34
Paris Police Department	Lamar	TX	54	1	18.52	2.01
Pauls Valley Police Department	Garvin	OK	13	1	76.92	3.63

Pearson Police Department	Atkinson	GA	5	1	200.00	11.94
Pelham Police Department	Mitchell	GA	14	1	71.43	4.26
Perry County Sheriff's Office	Perry	IL	12	1	83.33	4.47
Perryville Police Department	Boyle	KY	1	1	1000.00	3.52
Petroleum County Sheriff's Office	Petroleum	MT	1	1	1000.00	202.43
Philadelphia Police Department	Neshoba	MS	27	1	37.04	3.37
Phillips County Sheriff's Office	Phillips	AR	16	1	62.50	4.60
Pineland Police Department	Sabine	TX	2	1	500.00	9.23
Pineview Police Department	Wilcox	GA	1	1	1000.00	10.80
Pink Hill Police Department	Lenoir	NC	2	1	500.00	1.68
Plainview Police Department	Hale	TX	34	1	29.41	2.76
Platteville Police Department	Grant	WI	20	1	50.00	1.95
Plattsburgh Police Department	Clinton	NY	47	1	21.28	1.22
Pocahontas County Sheriff's Office	Pocahontas	WV	5	1	200.00	11.47
Polk County Police Department	Polk	GA	35	3	85.71	7.23
Polk County Sheriff's Office	Polk	GA	27	2	74.07	4.82
Poplar Bluff Police Department	Butler	MO	43	1	23.26	2.34
Port Barre Police Dept	St. Landry	LA	7	1	142.86	1.20
Port Jefferson Police Department	Shelby	OH	0	1		2.02
Powell County Sheriff's Office	Powell	MT	10	1	100.00	14.23
Princeton Police Department	Mercer	WV	17	2	117.65	3.21
Providence Police Department	Webster	KY	7	1	142.86	7.34
Pulaski County Sheriff's Office	Pulaski	IL	11	2	181.82	32.46
Putnam County Sheriff's Office	Putnam	TN	58	2	34.48	2.77
Quincy Police Department	Grant	WA	12	1	83.33	1.12
Rainsville Police Department	DeKalb	AL	11	1	90.91	1.41
Randolph County Sheriff's Office	Randolph	IL	13	1	76.92	2.99
Ranger Police Department	Eastland	TX	5	1	200.00	5.38
Ravalli County Sheriff's Office	Ravalli	MT	29	1	34.48	2.49
Ravenna Police Dept	Buffalo	NE	3	1	333.33	2.17
Red Springs Police Department	Robeson	NC	16	1	62.50	0.75
Richland Police Dept	Pulaski	MO	5	1	200.00	1.91
Richmond Police Department	Madison	KY	65	1	15.38	1.21
Ridgeville Police	Randolph	IN	2	1	500.00	3.82
Ridgeville Police Department	Dorchester	SC	2	1	500.00	2.57
Rio Arriba County Sheriff's Office	Rio Arriba	NM	22	1	45.45	2.48

Ripley Police Department	Jackson	WV	9	1	111.11	3.42
Robbins Police Department	Moore	NC	5	1	200.00	1.13
Robeson County Sheriff's Office	Robeson	NC	128	3	23.44	2.24
Rochelle Police Department	Wilcox	GA	4	1	250.00	10.80
Rockmart Police Department	Polk	GA	18	1	55.56	2.41
Roodhouse Police Dept	Greene	IL	4	1	250.00	7.20
Roosevelt County Sheriff's Office	Roosevelt	MT	11	1	90.91	9.59
Roseboro Police Department	Sampson	NC	5	2	400.00	3.15
Rosebud Sioux Tribal Police	Todd	SD	27	1	37.04	10.40
Rosedale Police Department	Bolivar	MS	5	1	200.00	2.93
Roswell Police Department	Chaves	NM	80	2	25.00	3.05
Routt County Sheriff's Office	Routt	CO	22	1	45.45	4.25
Royston Police Department	Franklin	GA	15	1	66.67	4.53
Ruidoso Police Department	Lincoln	NM	26	1	38.46	4.88
Russellville Police Department	Franklin	AL	25	2	80.00	6.31
Rutland Police Department.	Rutland	VT	41	1	24.39	1.62
Saline County Sheriff's Office	Saline	KS	44	1	22.73	1.80
Saline County Sheriff's Office	Saline	IL	42	1	23.81	4.01
San Jacinto County Sheriff's Office	San Jacinto	TX	21	1	47.62	3.79
Sandusky Police Department	Erie	OH	54	2	37.04	2.59
Sanford Police Department	Lee	NC	81	1	12.35	1.73
Santa Clara Police Department	Grant	NM	5	1	200.00	3.39
Santee Police Department	Orangeburg	SC	6	2	333.33	2.16
Sauk County Sheriff's Office	Sauk	WI	118	1	8.47	1.61
Sault Ste. Marie Police Department	Chippewa	MI	25	1	40.00	2.60
Scotts Hill Police Department	Henderson	TN	3	1	333.33	3.60
Scottsbluff Police Dept	Scotts Bluff	NE	30	1	33.33	2.70
Scottsboro Police Department	Jackson	AL	44	1	22.73	1.88
Seadrift Police Department	Calhoun	TX	2	1	500.00	4.68
Searcy Police Department	White	AR	41	1	24.39	1.30
Seaside Police Department	Clatsop	OR	18	1	55.56	2.70
Sedalia Police Dept	Pettis	MO	44	1	22.73	2.37
Selma Police Department	Dallas	AL	50	2	40.00	4.56
Selmer Police Department	McNairy	TN	18	1	55.56	3.84
Seneca County Sheriff's Office	Seneca	NY	23	6	260.87	17.02
Seneca Police Department	Oconee	SC	34	1	29.41	1.35

Sevierville Police Department	Sevier	TN	55	1	18.18	1.11
Seymour Police	Jackson	IN	39	1	25.64	2.36
Shawnee Police Department	Pottawatomie	OK	52	1	19.23	1.44
Shelby County Sheriff's Office	Shelby	OH	30	1	33.33	2.02
Shelby County Sheriff's Office	Shelby	TX	15	2	133.33	7.86
Shelby Police Department	Cleveland	NC	70	1	14.29	1.02
Shelby Police Department	Bolivar	MS	7	2	285.71	5.86
Shenandoah Borough Police Department	Schuylkill	PA	7	4	571.43	2.70
Shinnston Police Department	Harrison	WV	7	2	285.71	2.89
Simpson County Sheriff's Office	Simpson	KY	11	1	90.91	5.77
Sleepy Eye Police Department	Redwood	MN	6	1	166.67	3.86
Socorro County Sheriff's Office	Socorro	NM	10	1	100.00	5.60
Spencer Police Department	Clay	IA	18	1	55.56	6.00
Springfield Police Department	Windsor	VT	15	1	66.67	1.76
Springfield Police Department	Orangeburg	SC	2	1	500.00	1.08
St. George Police Department	Dorchester	SC	10	1	100.00	2.57
St. Landry Parish Sheriff's Office	St. Landry	LA	90	4	44.44	4.80
St. Marys Police Department	Auglaize	OH	15	1	66.67	2.18
St. Paul Police Department	Wise	VA	6	1	166.67	2.41
Stanly County Sheriff's Office	Stanly	NC	49	1	20.41	1.65
Stark County Sheriff's Office	Stark	ND	11	1	90.91	4.13
Starr County Sheriff's Office	Starr	TX	31	1	32.26	1.64
Stephens County Sheriff's Office	Stephens	GA	31	1	32.26	3.82
Stephens County Sheriff's Office	Stephens	OK	11	2	181.82	4.44
Steuben County Sheriff's Office	Steuben	NY	26	1	38.46	1.01
Stillwater Police Department	Payne	OK	74	1	13.51	1.29
Stover Police Department	Morgan	MO	3	1	333.33	4.86
Sturgis Police Department	St. Joseph	MI	19	1	52.63	1.63
Sugarcreek Borough Police Department	Venango	PA	5	1	200.00	1.82
Sugarcreek Police Department	Tuscarawas	OH	5	1	200.00	1.08
Sullivan County Sheriff's Office	Sullivan	NY	44	1	22.73	1.29
Sweetwater Police Department	Monroe	TN	18	1	55.56	2.25
Tabor City Police Department	Columbus	NC	9	2	222.22	3.44
Tahlequah Police Department	Cherokee	OK	32	1	31.25	2.13
Talbot County Sheriff's Office	Talbot	GA	8	3	375.00	43.70
Terrell County Sheriff's Office	Terrell	TX	5	1	200.00	101.63

Thief River Falls Police Department	Pennington	MN	15	1	66.67	7.18
Thomas County Sheriff's Office	Thomas	GA	47	2	42.55	4.47
Tipton Police Department	Tillman	OK	1	1	1000.00	12.51
Torrington Police Department	Litchfield	CT	79	1	12.66	0.53
Towns County Sheriff's Office	Towns	GA	18	1	55.56	9.55
Traverse City Police Department	Grand Traverse	MI	32	1	31.25	1.15
Tucumcari Police Department	Quay	NM	13	1	76.92	11.06
Tupelo Police Department	Lee	MS	115	1	8.70	1.21
Turkey Creek Police Department	Evangeline	LA	1	1	1000.00	2.94
Tuscola County Sheriff's Office	Tuscola	MI	25	1	40.00	1.79
Tuskegee Police Department	Macon	AL	23	2	86.96	9.32
Tuskegee University Police Department	Macon	AL	33	1	30.30	4.66
Tutwiler Police Department	Tallahatchie	MS	4	1	250.00	6.50
Twin Falls Police Department	Twin Falls	ID	64	1	15.63	1.29
Union City Police Department	Obion	TN	36	1	27.78	3.14
Union Police Department	Newton	MS	7	1	142.86	4.60
University of West Alabama Police	Sumter	AL	6	1	166.67	7.27
Upper Sandusky Police Department	Wyandot	OH	13	1	76.92	4.42
Vail Police Department	Eagle	CO	28	1	35.71	1.92
Vergennes Police Department	Addison	VT	5	1	200.00	2.72
Vernal Police Department	Uintah	UT	22	1	45.45	3.07
Vernon Parish Sheriff's Office	Vernon	LA	64	2	31.25	3.82
Vidalia Police Department	Concordia	LA	20	1	50.00	4.80
Vinita Police Department	Craig	OK	15	1	66.67	6.65
Virginia Marine Resources Commission	Newport News City	VA	60	1	16.67	3.02
Wakeman Police Department	Huron	OH	1	1	1000.00	1.68
Wallace Police Department	Duplin	NC	12	1	83.33	1.71
Warren County Sheriff's Office	Warren	NC	30	1	33.33	4.77
Washington Court House Police Dept.	Fayette	OH	22	1	45.45	3.44
Washington Police Department	Beaufort	NC	36	1	27.78	2.09
Waukomis Police Department	Garfield	OK	3	1	333.33	1.65
Waynesburg Borough Police Department	Greene	PA	8	1	125.00	2.58
West Yellowstone Police Department	Gallatin	MT	5	1	200.00	1.12
Wheeler Police Department	Dunn	WI	0	1		2.28
White Cloud Police Department	Newaygo	MI	2	1	500.00	2.06
White County Sheriff's Office	White	GA	40	1	25.00	3.68

White County Sheriff's Office	White	TN	28	1	35.71	3.87
Whiteville Police Department	Hardeman	TN	8	1	125.00	3.67
Whitley County Sheriff's Office	Whitley	KY	12	1	83.33	2.81
Wilkesboro Police Department	Wilkes	NC	20	1	50.00	1.44
Williams Police Department	Colusa	CA	10	1	100.00	4.67
Williamsburg Police Department	Whitley	KY	12	1	83.33	2.81
Wilson Police Department	Wilson	NC	114	2	17.54	2.46
Wilson Police Department	Ellsworth	KS	1	1	1000.00	15.39
Windber Borough Police Department	Somerset	PA	2	1	500.00	1.29
Winkler County Sheriff's Office	Winkler	TX	10	1	100.00	14.06
Winn Parish Sheriff's Office	Winn	LA	23	1	43.48	6.53
Winnemucca Police Department	Humboldt	NV	18	1	55.56	6.05
Winnfield Police Dept	Winn	LA	13	1	76.92	6.53
Winnsboro Police Department	Franklin	LA	7	1	142.86	4.82
Winsted Police Department	Litchfield	CT	4	1	250.00	0.53
Wolfeboro Police Department	Carroll	NH	12	1	83.33	2.09
Woodruff County Sheriff's Office	Woodruff	AR	6	1	166.67	13.77
Woodstock Police Department	Grafton	NH	5	1	200.00	1.12
Yemassee Police Department	Hampton	SC	7	1	142.86	4.74
Zanesville Police Department	Muskingum	OH	53	3	56.60	3.49
Zapata County Sheriff's Office	Zapata	TX	44	1	22.73	7.13
Zolfo Springs Police Department	Hardee	FL	1	1	1000.00	3.61

Table 80. Primary State Police Agencies in Study: Rates of Officers Arrested, 2005-2011 (Sorted Alphabetically)

Agency	County	State	# of Full-Time Sworn Personnel	Per Agency	Per 1,000 Officers	Per 100,000 Population
Alabama Department of Public Safety	Montgomery	AL	763	2	2.62	0.04
Alaska State Troopers	Anchorage	AK	274	1	3.65	0.14
Arizona Department of Public Safety	Maricopa	AZ	1244	3	2.41	0.05
Arkansas Highway Police	Pulaski	AR	149	2	13.42	0.07
Arkansas State Police	Pulaski	AR	525	2	3.81	0.07
California Highway Patrol	Sacramento	CA	7202	13	1.81	0.03
Colorado State Patrol	Jefferson	CO	742	4	5.39	0.08
Connecticut State Police	Middlesex	CT	1227	4	3.26	0.11
Delaware State Police	Kent	DE	658	3	4.56	0.33
Florida Highway Patrol	Leon	FL	1606	14	8.72	0.07
Georgia Department of Public Safety	Fulton	GA	1048	1	0.95	0.01
Idaho State Police	Ada	ID	264	1	3.79	0.06
Illinois State Police	Sangamon	IL	2105	10	4.75	0.08
Indiana State Police	Marion	IN	1315	4	3.04	0.06
Iowa Department of Public Safety	Polk	IA	669	2	2.99	0.07
Kentucky State Police	Franklin	KY	882	3	3.40	0.07
Louisiana State Police	East Baton Rouge	LA	1215	2	1.65	0.04
Maine State Police	Kennebec	ME	334	1	2.99	0.08
Maryland State Police	Baltimore	MD	1440	9	6.25	0.16
Massachusetts State Police	Middlesex	MA	2310	10	4.33	0.15
Michigan State Police	Ingham	MI	1732	9	5.20	0.09
Minnesota State Patrol	Ramsey	MN	530	4	7.55	0.08
Mississippi Highway Safety Patrol	Hinds	MS	594	6	10.10	0.20
Nebraska State Patrol	Lancaster	NE	491	1	2.04	0.05
Nevada Highway Patrol	Carson	NV	417	3	7.19	0.11
New Hampshire State Police	Merrimack	NH	350	3	8.57	0.23
New Jersey State Police	Mercer	NJ	3053	13	4.26	0.15
New Mexico State Police	Santa Fe	NM	528	13	24.62	0.63
New York State Police	Albany	NY	4847	5	1.03	0.03
North Carolina State Highway Patrol	Wake	NC	1827	8	4.38	0.08
Ohio State Highway Patrol	Franklin	OH	1560	4	2.56	0.03
Oklahoma Department of Public Safety	Oklahoma	OK	825	5	6.06	0.13

Pennsylvania State Police	Dauphin	PA	4458	26	5.83	0.20
Rhode Island State Police	Providence	RI	201	2	9.95	0.19
South Carolina Highway Patrol	Richland	SC	967	10	10.34	0.22
Tennessee Department of Safety	Davidson	TN	942	4	4.25	0.06
Texas Department of Public Safety	Travis	TX	3529	6	1.70	0.02
Utah Department of Public Safety	Salt Lake	UT	475	2	4.21	0.07
Vermont State Police	Washington	VT	307	1	3.26	0.16
Virginia State Police	Chesterfield	VA	1873	3	1.60	0.04
Washington State Patrol	Thurston	WA	1132	2	1.77	0.03
Wyoming Highway Patrol	Laramie	WY	204	1	4.90	0.18

Table 81. Sheriff's Offices in Study: Rates of Officers Arrested, 2005-2011 (Sorted Alphabetically)

Agency	County	State	# of Full-Time Sworn Personnel	Per Agency	Per 1,000 Officers	Per 100,000 Population
Acadia Parish Sheriff's Office	Acadia	LA	105	1	9.52	1.62
Accomack County Sheriff's Office	Accomack	VA	27	1	37.04	3.02
Adams County Sheriff's Office	Adams	CO	364	2	5.49	0.45
Alachua County Sheriff's Office	Alachua	FL	276	1	3.62	0.40
Alameda County Sheriff's Office	Alameda	CA	928	2	2.16	0.13
Allegan County Sheriff's Office	Allegan	MI	59	1	16.95	0.90
Allegheny County Sheriff's Office	Allegheny	PA	151	3	19.87	0.25
Anderson County Sheriff's Office	Anderson	SC	191	2	10.47	1.07
Anoka County Sheriff's Office	Anoka	MN	133	1	7.52	0.30
Arapahoe County Sheriff's Office	Arapahoe	CO	407	2	4.91	0.35
Assumption Parish Sheriff's Office	Assumption	LA	50	2	40.00	8.54
Atlantic County Sheriff's Office	Atlantic	NJ	103	1	9.71	0.36
Baker County Sheriff's Office	Baker	GA	3	1	333.33	28.98
Baltimore (City) Sheriff's Office	Baltimore City	MD	99	2	20.20	0.32
Baltimore County Sheriff's Office	Baltimore	MD	84	1	11.90	0.12
Barnstable County Sheriff's Office	Barnstable	MA	254	5	19.69	2.32
Barrow County Sheriff's Office	Barrow	GA	127	1	7.87	1.44
Baxter County Sheriff's Office	Baxter	AR	32	1	31.25	2.41
Bay County Sheriff's Office	Bay	FL	213	2	9.39	1.18
Beaufort County Sheriff's Office	Beaufort	SC	209	1	4.78	0.62
Bedford County Sheriff's Office	Bedford	VA	77	2	25.97	2.91
Benton County Sheriff's Office	Benton	AR	103	1	9.71	0.45
Benzie County Sheriff's Office	Benzie	MI	13	1	76.92	5.71
Bernalillo County Sheriff's Office	Bernalillo	NM	279	3	10.75	0.45
Bexar County Sheriff's Office	Bexar	TX	526	5	9.51	0.29
Bibb County Sheriff's Office	Bibb	AL	12	1	83.33	4.36
Bibb County Sheriff's Office	Bibb	GA	290	3	10.34	1.93
Big Horn County Sheriff's Office	Big Horn	MT	8	1	125.00	7.77
Blackford County Sheriff's Office	Blackford	IN	8	1	125.00	7.83
Bolivar County Sheriff's Office	Bolivar	MS	18	1	55.56	2.93
Boone County Sheriff's Office	Boone	KY	130	1	7.69	0.84
Bossier Parish Sheriff's Office	Bossier	LA	300	3	10.00	2.56

Boulder County Sheriff's Office	Boulder	CO	174	1	5.75	0.34
Bracken County Sheriff's Office	Bracken	KY	4	1	250.00	11.78
Brazoria County Sheriff's Office	Brazoria	TX	127	1	7.87	0.32
Brevard County Sheriff's Office	Brevard	FL	497	2	4.02	0.37
Broward County Sheriff's Office	Broward	FL	1624	16	9.85	0.92
Brunswick County Sheriff's Office	Brunswick	NC	114	2	17.54	1.86
Bucks County Sheriff's Office	Bucks	PA	50	2	40.00	0.32
Bullitt County Sheriff's Office	Bullitt	KY	40	1	25.00	1.35
Burke County Sheriff's Office	Burke	NC	86	1	11.63	1.10
Burleigh County Sheriff's Office	Burleigh	ND	40	2	50.00	2.46
Butler County Sheriff's Office	Butler	AL	9	3	333.33	14.32
Butte County Sheriff's Office	Butte	CA	110	1	9.09	0.45
Calcasieu Parish Sheriff's Office	Calcasieu	LA	592	1	1.69	0.52
Calhoun County Sheriff's Office	Calhoun	FL	18	1	55.56	6.84
Cameron County Sheriff's Office	Cameron	TX	107	2	18.69	0.49
Campbell County Sheriff's Office	Campbell	WY	58	1	17.24	2.17
Caroline County Sheriff's Office	Caroline	VA	49	3	61.22	10.51
Carter County Sheriff's Office	Carter	MO	3	2	666.67	31.92
Carver County Sheriff's Office	Carver	MN	87	1	11.49	1.10
Catawba County Sheriff's Office	Catawba	NC	126	1	7.94	0.65
Centre County Sheriff's Office	Centre	PA	17	1	58.82	0.65
Chambers County Sheriff's Office	Chambers	TX	44	1	22.73	2.85
Charleston County Sheriff's Office	Charleston	SC	259	4	15.44	1.14
Charlotte County Sheriff's Office	Charlotte	FL	285	3	10.53	1.88
Cherokee County Sheriff's Office	Cherokee	SC	48	2	41.67	3.61
Chesapeake (City) Sheriff's Office	Chesapeake City	VA	358	2	5.59	0.90
Chesterfield County Sheriff's Office	Chesterfield	SC	41	1	24.39	2.14
Chesterfield County Sheriff's Office	Chesterfield	VA	225	1	4.44	0.32
Clackamas County Sheriff's Office	Clackamas	OR	319	2	6.27	0.53
Clark County Sheriff's Office	Clark	IN	35	1	28.57	0.91
Clark County Sheriff's Office	Clark	OH	134	1	7.46	0.72
Clarke County Sheriff's Office	Clarke	VA	18	1	55.56	7.13
Clay County Sheriff's Office	Clay	AR	7	1	142.86	6.22
Clay County Sheriff's Office	Clay	FL	284	3	10.56	1.57
Clay County Sheriff's Office	Clay	IN	30	1	33.33	3.72
Clay County Sheriff's Office	Clay	MO	115	1	8.70	0.45

Clayton County Sheriff's Office	Clayton	IA	12	1	83.33	5.52
Cleveland County Sheriff's Office	Cleveland	OK	70	1	14.29	0.39
Cobb County Sheriff's Office	Cobb	GA	435	1	2.30	0.15
Collier County Sheriff's Office	Collier	FL	628	6	9.55	1.87
Columbia County Sheriff's Office	Columbia	GA	206	2	9.71	1.61
Columbia County Sheriff's Office	Columbia	OR	41	1	24.39	2.03
Columbiana County Sheriff's Office	Columbiana	OH	22	2	90.91	1.85
Contra Costa County Sheriff's Office	Contra Costa	CA	679	1	1.47	0.10
Cook County Sheriff's Office	Cook	IL	5655	8	1.41	0.15
Coweta County Sheriff's Office	Coweta	GA	137	1	7.30	0.79
Crawford County Sheriff's Office	Crawford	AR	27	1	37.04	1.61
Cross County Sheriff's Office	Cross	AR	17	1	58.82	5.60
Cullman County Sheriff's Office	Cullman	AL	78	1	12.82	1.24
Custer County Sheriff's Office	Custer	OK	12	1	83.33	3.64
Cuyahoga County Sheriff's Office	Cuyahoga	OH	141	3	21.28	0.23
Dade County Sheriff's Office	Dade	GA	25	1	40.00	0.04
Dakota County Sheriff's Office	Dakota	MN	77	1	12.99	0.25
Dale County Sheriff's Office	Dale	AL	0	1		1.99
Dallas County Sheriff's Office	Dallas	IA	23	2	86.96	3.02
Dallas County Sheriff's Office	Dallas	TX	449	1	2.23	0.04
Dane County Sheriff's Office	Dane	WI	454	2	4.41	0.41
Darlington County Sheriff's Office	Darlington	SC	64	1	15.63	1.46
Dauphin County Sheriff's Office	Dauphin	PA	36	2	55.56	0.75
Davie County Sheriff's Office	Davie	NC	45	3	66.67	7.27
Daviess County Sheriff's Office	Daviess	IN	19	1	52.63	3.16
Dearborn County Sheriff's Office	Dearborn	IN	29	2	68.97	4.00
DeKalb County Sheriff's Office	DeKalb	AL	34	1	29.41	1.41
DeKalb County Sheriff's Office	DeKalb	GA	325	2	6.15	0.29
Del Norte County Sheriff's Office	Del Norte	CA	30	2	66.67	6.99
Delaware County Sheriff's Office	Delaware	OH	86	1	11.63	0.57
Delaware County Sheriff's Office	Delaware	PA	58	2	34.48	0.36
Denver County Sheriff's Office	Denver	CO	739	5	6.77	0.83
Dewitt County Sheriff's Office	De Witt	IL	16	1	62.50	6.04
Douglas County Sheriff's Office	Douglas	NV	100	1	10.00	2.13
Duval County Sheriff's Office	Duval	TX	18	1	55.56	8.49
East Baton Rouge Parish Sheriff's Office	East Baton Rouge	LA	359	3	8.36	0.68

Eaton County Sheriff's Office	Eaton	MI	77	1	12.99	0.93
El Paso County Sheriff's Office	El Paso	CO	454	1	2.20	0.16
El Paso County Sheriff's Office	El Paso	TX	248	2	8.06	0.25
Elko County Sheriff's Office	Elko	NV	57	1	17.54	2.05
Emery County Sheriff's Office	Emery	UT	26	2	76.92	18.22
Emmet County Sheriff's Office	Emmet	MI	23	1	43.48	3.06
Escambia County Sheriff's Office	Escambia	FL	388	3	7.73	1.01
Estill County Sheriff's Office	Estill	KY	5	1	200.00	6.82
Fairfax County Sheriff's Office	Fairfax	VA	499	3	6.01	0.28
Fayette County Sheriff's Office	Fayette	OH	22	3	136.36	10.33
Ferry County Sheriff's Office	Ferry	WA	10	1	100.00	13.24
Flagler County Sheriff's Office	Flagler	FL	130	2	15.38	2.09
Floyd County Sheriff's Office	Floyd	IA	11	1	90.91	6.13
Forsyth County Sheriff's Office	Forsyth	GA	253	5	19.76	2.85
Forsyth County Sheriff's Office	Forsyth	NC	217	2	9.22	0.57
Franklin County Sheriff's Office	Franklin	IN	12	1	83.33	4.33
Franklin County Sheriff's Office	Franklin	OH	455	2	4.40	0.17
Franklin County Sheriff's Office	Franklin	VA	78	1	12.82	1.78
Frederick County Sheriff's Office	Frederick	MD	177	1	5.65	0.43
Fremont County Sheriff's Office	Fremont	IA	7	1	142.86	13.44
Fresno County Sheriff's Office	Fresno	CA	461	1	2.17	0.11
Fulton County Sheriff's Office	Fulton	GA	516	4	7.75	0.43
Gage County Sheriff's Office	Gage	NE	12	1	83.33	4.48
Gallatin County Sheriff's Office	Gallatin	IL	3	1	333.33	17.89
Galveston County Sheriff's Office	Galveston	TX	240	1	4.17	0.34
Graham County Sheriff's Office	Graham	AZ	23	1	43.48	2.69
Grand Traverse County Sheriff's Office	Grand Traverse	MI	64	2	31.25	2.30
Grant County Sheriff's Office	Grant	IN	45	1	22.22	1.43
Grant County Sheriff's Office	Grant	OK	5	1	200.00	22.09
Greenbrier County Sheriff's Office	Greenbrier	WV	30	1	33.33	2.82
Greene County Sheriff's Office	Greene	AL	11	1	90.91	11.06
Greene County Sheriff's Office	Greene	AR	15	1	66.67	2.38
Greenville County Sheriff's Office	Greenville	SC	397	2	5.04	0.44
Griggs County Sheriff's Office	Griggs	ND	3	1	333.33	41.32
Guadalupe County Sheriff's Office	Guadalupe	NM	3	1	333.33	21.34
Gwinnett County Sheriff's Office	Gwinnett	GA	531	3	5.65	0.37

Halifax County Sheriff's Office	Halifax	VA	29	1	34.48	2.76
Hall County Sheriff's Office	Hall	GA	257	2	7.78	1.11
Hamilton County Sheriff's Office	Hamilton	IN	64	1	15.63	0.36
Hamilton County Sheriff's Office	Hamilton	OH	330	1	3.03	0.12
Hamilton County Sheriff's Office	Hamilton	TN	146	2	13.70	0.59
Hampton County Sheriff's Office	Hampton	SC	26	1	38.46	4.74
Hancock County Sheriff's Office	Hancock	IN	40	3	75.00	4.29
Hardeman County Sheriff's Office	Hardeman	TN	22	1	45.45	3.67
Harford County Sheriff's Office	Harford	MD	280	1	3.57	0.41
Harris County Sheriff's Office	Harris	TX	2558	3	1.17	0.07
Harrison County Sheriff's Office	Harrison	IN	22	1	45.45	2.54
Harrison County Sheriff's Office	Harrison	MS	90	1	11.11	0.53
Harrison County Sheriff's Office	Harrison	TX	45	1	22.22	1.52
Hawkins County Sheriff's Office	Hawkins	TN	42	1	23.81	1.76
Haywood County Sheriff's Office	Haywood	TN	22	1	45.45	5.32
Hempstead County Sheriff's Office	Hempstead	AR	13	1	76.92	4.42
Hendry County Sheriff's Office	Hendry	FL	67	1	14.93	2.55
Henry County Sheriff's Office	Henry	AL	8	1	125.00	5.78
Henry County Sheriff's Office	Henry	VA	112	14	125.00	25.85
Hernando County Sheriff's Office	Hernando	FL	249	1	4.02	0.58
Hidalgo County Sheriff's Office	Hidalgo	TX	262	5	19.08	0.65
Highlands County Sheriff's Office	Highlands	FL	130	1	7.69	1.01
Hillsborough County Sheriff's Office	Hillsborough	FL	1223	10	8.18	0.81
Hockley County Sheriff's Office	Hockley	TX	11	2	181.82	8.72
Hoke County Sheriff's Office	Hoke	NC	50	1	20.00	2.13
Holmes County Sheriff's Office	Holmes	OH	33	1	30.30	2.36
Holt County Sheriff's Office	Holt	NE	5	1	200.00	9.58
Horry County Sheriff's Office	Horry	SC	55	1	18.18	0.37
Hudson County Sheriff's Office	Hudson	NJ	221	3	13.57	0.47
Hunterdon County Sheriff's Office	Hunterdon	NJ	17	1	58.82	0.78
Iberia Parish Sheriff's Office	Iberia	LA	242	6	24.79	8.19
Indian River County Sheriff's Office	Indian River	FL	226	3	13.27	2.17
Isle of Wight County Sheriff's Office	Isle of Wight	VA	40	1	25.00	2.84
Jackson County Sheriff's Office	Jackson	FL	61	1	16.39	2.01
Jackson County Sheriff's Office	Jackson	KS	15	1	66.67	7.43
Jackson County Sheriff's Office	Jackson	TN	14	3	214.29	25.78

Jefferson Parish Sheriff's Office	Jefferson	LA	825	12	14.55	2.77
Jim Wells County Sheriff's Office	Jim Wells	TX	27	1	37.04	2.45
Johnston County Sheriff's Office	Johnston	NC	97	1	10.31	0.59
Juneau County Sheriff's Office	Juneau	WI	45	1	22.22	3.75
Kane County Sheriff's Office	Kane	IL	92	1	10.87	0.19
Kenosha County Sheriff's Office	Kenosha	WI	122	1	8.20	0.60
Kent County Sheriff's Office	Kent	DE	5	1	200.00	0.62
Keokuk County Sheriff's Office	Keokuk	IA	4	1	250.00	9.51
Kern County Sheriff's Office	Kern	CA	512	11	21.48	1.31
Kershaw County Sheriff's Office	Kershaw	SC	61	1	16.39	1.62
King County Sheriff's Office	King	WA	721	5	6.93	0.26
Kingfisher County Sheriff's Office	Kingfisher	OK	8	1	125.00	6.65
Kitsap County Sheriff's Office	Kitsap	WA	121	1	8.26	0.40
Knox County Sheriff's Office	Knox	TN	456	1	2.19	0.23
La Crosse County Sheriff's Office	La Crosse	WI	43	1	23.26	0.87
La Porte County Sheriff's Office	La Porte	IN	58	1	17.24	0.90
La Salle County Sheriff's Office	La Salle	IL	36	1	27.78	0.88
La Salle County Sheriff's Office	La Salle	TX	10	3	300.00	43.57
Lafourche Parish Sheriff's Office	Lafourche	LA	287	3	10.45	3.11
Lake County Sheriff's Office	Lake	CA	61	2	32.79	3.09
Lake County Sheriff's Office	Lake	CO	9	2	222.22	27.36
Lake County Sheriff's Office	Lake	FL	286	3	10.49	1.01
Lake County Sheriff's Office	Lake	IL	188	1	5.32	0.14
Lake County Sheriff's Office	Lake	IN	170	5	29.41	1.01
Lake County Sheriff's Office	Lake	SD	5	1	200.00	8.93
Lancaster County Sheriff's Office	Lancaster	SC	93	1	10.75	1.30
Laurens County Sheriff's Office	Laurens	SC	65	1	15.38	1.50
Lawrence County Sheriff's Office	Lawrence	IN	25	1	40.00	2.17
Lee County Sheriff's Office	Lee	FL	621	7	11.27	1.13
Lee County Sheriff's Office	Lee	NC	47	1	21.28	1.73
Lee County Sheriff's Office	Lee	SC	28	1	35.71	5.20
Lenawee County Sheriff's Office	Lenawee	MI	44	1	22.73	1.00
Lenoir County Sheriff's Office	Lenoir	NC	58	2	34.48	3.36
Leon County Sheriff's Office	Leon	FL	443	3	6.77	1.09
Lewis County Sheriff's Office	Lewis	MO	5	1	200.00	9.79
Liberty County Sheriff's Office	Liberty	TX	37	2	54.05	2.64

Lincoln County Sheriff's Office	Lincoln	GA	12	1	83.33	12.51
Lincoln County Sheriff's Office	Lincoln	NC	98	4	40.82	5.11
Lincoln County Sheriff's Office	Lincoln	OR	65	1	15.38	2.17
Lincoln County Sheriff's Office	Lincoln	SD	17	1	58.82	2.23
Lincoln Parish Sheriff's Office	Lincoln	LA	46	1	21.74	2.14
Livingston County Sheriff's Office	Livingston	MI	65	2	30.77	1.11
Livingston Parish Sheriff's Office	Livingston	LA	125	1	8.00	0.78
Long County Sheriff's Office	Long	GA	15	1	66.67	6.91
Los Angeles County Sheriff's Office	Los Angeles	CA	9461	14	1.48	0.14
Loudoun County Sheriff's Office	Loudoun	VA	448	2	4.46	0.64
Lowndes County Sheriff's Office	Lowndes	AL	14	1	71.43	8.85
Lowndes County Sheriff's Office	Lowndes	GA	145	1	6.90	0.92
Lucas County Sheriff's Office	Lucas	OH	289	4	13.84	0.91
Luna County Sheriff's Office	Luna	NM	30	1	33.33	3.98
Luzerne County Sheriff's Office	Luzerne	PA	38	2	52.63	0.62
Macomb County Sheriff's Office	Macomb	MI	245	1	4.08	0.12
Madera County Sheriff's Office	Madera	CA	78	1	12.82	0.66
Madison County Sheriff's Office	Madison	AL	107	1	9.35	0.30
Madison County Sheriff's Office	Madison	GA	34	1	29.41	3.56
Madison County Sheriff's Office	Madison	MO	8	1	125.00	8.18
Manatee County Sheriff's Office	Manatee	FL	476	4	8.40	1.24
Marathon County Sheriff's Office	Marathon	WI	67	1	14.93	0.75
Maricopa County Sheriff's Office	Maricopa	AZ	766	2	2.61	0.05
Marin County Sheriff's Office	Marin	CA	202	1	4.95	0.40
Marion County Sheriff's Office	Marion	FL	349	3	8.60	0.91
Marion County Sheriff's Office	Marion	IN	740	7	9.46	0.77
Marion County Sheriff's Office	Marion	OR	255	1	3.92	0.32
Marion County Sheriff's Office	Marion	WV	27	1	37.04	1.77
Marlboro County Sheriff's Office	Marlboro	SC	25	2	80.00	6.91
Martin County Sheriff's Office	Martin	FL	414	1	2.42	0.68
Martin County Sheriff's Office	Martin	NC	34	1	29.41	4.08
Mason County Sheriff's Office	Mason	WV	21	3	142.86	10.98
McDowell County Sheriff's Office	McDowell	NC	40	1	25.00	2.22
McDowell County Sheriff's Office	McDowell	WV	15	1	66.67	4.52
McHenry County Sheriff's Office	McHenry	IL	134	2	14.93	0.65
McIntosh County Sheriff's Office	McIntosh	OK	17	2	117.65	9.88

McKinley County Sheriff's Office	McKinley	NM	35	1	28.57	1.40
Mesilla Marshal's Office	Dona Ana	NM	5	1	200.00	0.48
Middlesex County Sheriff's Department	Middlesex	NJ	170	4	23.53	0.49
Middlesex County Sheriff's Office	Middlesex	VA	17	1	58.82	9.12
Miller County Sheriff's Office	Miller	MO	16	1	62.50	4.04
Milwaukee County Sheriff's Office	Milwaukee	WI	524	7	13.36	0.74
Minnehaha County Sheriff's Office	Minnehaha	SD	69	1	14.49	0.59
Monmouth County Sheriff's Office	Monmouth	NJ	494	1	2.02	0.16
Monroe County Sheriff's Office	Monroe	FL	189	3	15.87	4.10
Monroe County Sheriff's Office	Monroe	NY	273	3	10.99	0.40
Monroe County Sheriff's Office	Monroe	WI	23	1	43.48	2.24
Montague County Sheriff's Office	Montague	TX	10	1	100.00	5.07
Montgomery County Sheriff's Office	Montgomery	OH	222	1	4.50	0.19
Montgomery County Sheriff's Office	Montgomery	TN	287	1	3.48	0.58
Mora County Sheriff's Office	Mora	NM	5	1	200.00	20.49
Morgan County Sheriff's Office	Morgan	AL	55	1	18.18	0.84
Morgan County Sheriff's Office	Morgan	IN	26	2	76.92	2.90
Morris County Sheriff's Office	Morris	NJ	262	1	3.82	0.20
Morrow County Sheriff's Office	Morrow	OR	14	1	71.43	8.95
Muskogee County Sheriff's Office	Muskogee	OK	37	1	27.03	1.41
Nassau County Sheriff's Office	Nassau	FL	109	2	18.35	2.73
New Hanover County Sheriff's Office	New Hanover	NC	315	3	9.52	1.48
New York City Sheriff's Office	New York	NY	120	2	16.67	2.44
Newaygo County Sheriff's Office	Newaygo	MI	25	1	40.00	2.06
Newton County Sheriff's Office	Newton	GA	152	1	6.58	1.00
Nez Perce County Sheriff's Office	Nez Perce	ID	25	2	80.00	5.09
Niagara County Sheriff's Office	Niagara	NY	110	1	9.09	0.46
Nicholas County Sheriff's Office	Nicholas	KY	1	1	1000.00	14.02
Norfolk (City) Sheriff's Office	Norfolk City	VA	414	1	2.42	0.41
Nye County Sheriff's Office	Nye	NV	108	3	27.78	6.83
Oglethorpe County Sheriff's Office	Oglethorpe	GA	19	1	52.63	6.71
Okaloosa County Sheriff's Office	Okaloosa	FL	258	3	11.63	1.66
Okanogan County Sheriff's Office	Okanogan	WA	30	1	33.33	2.43
Onondaga County Sheriff's Office	Onondaga	NY	242	1	4.13	0.21
Orange County Sheriff-Coroner Department	Orange	CA	1794	14	7.80	0.47
Orange County Sheriff's Office	Orange	FL	1398	16	11.44	1.40

Orange County Sheriff's Office	Orange	NY	99	1	10.10	0.27
Orange County Sheriff's Office	Orange	NC	115	1	8.70	0.75
Orangeburg County Sheriff's Office	Orangeburg	SC	92	1	10.87	1.08
Oregon County Sheriff's Office	Oregon	MO	5	2	400.00	18.38
Orleans County Sheriff's Office	Orleans	NY	29	1	34.48	2.33
Orleans Parish Sheriff's Office (Criminal Division)	Orleans	LA	505	4	7.92	1.16
Osceola County Sheriff's Office	Osceola	FL	388	2	5.15	0.74
Osceola County Sheriff's Office	Osceola	MI	18	1	55.56	4.25
Otero County Sheriff's Office	Otero	NM	30	1	33.33	1.57
Ouachita Parish Sheriff's Office	Ouachita	LA	431	1	2.32	0.65
Outagamie County Sheriff's Office	Outagamie	WI	74	1	13.51	0.57
Ozaukee County Sheriff's Office	Ozaukee	WI	83	1	12.05	1.16
Page County Sheriff's Office	Page	VA	49	1	20.41	4.16
Palm Beach County Sheriff's Office	Palm Beach	FL	1447	12	8.29	0.91
Pasco County Sheriff's Office	Pasco	FL	485	4	8.25	0.86
Passaic County Sheriff's Office	Passaic	NJ	530	6	11.32	1.20
Paulding County Sheriff's Office	Paulding	GA	175	1	5.71	0.70
Pawnee County Sheriff's Office	Pawnee	OK	19	1	52.63	6.03
Pender County Sheriff's Office	Pender	NC	57	1	17.54	1.92
Pennington County Sheriff's Office	Pennington	SD	65	1	15.38	0.99
Perry County Sheriff's Office	Perry	IL	12	1	83.33	4.47
Petroleum County Sheriff's Office	Petroleum	MT	1	1	1000.00	202.43
Phillips County Sheriff's Office	Phillips	AR	16	1	62.50	4.60
Pierce County Sheriff's Office	Pierce	WA	292	2	6.85	0.25
Pima County Sheriff's Dept.	Pima	AZ	554	1	1.81	0.10
Pinal County Sheriff's Office	Pinal	AZ	218	2	9.17	0.53
Pinellas County Sheriff's Office	Pinellas	FL	863	8	9.27	0.87
Pitt County Sheriff's Office	Pitt	NC	125	3	24.00	1.78
Placer County Sheriff's Office	Placer	CA	228	1	4.39	0.29
Plaquemines Parish Sheriff's Office	Plaquemines	LA	145	1	6.90	4.34
Pocahontas County Sheriff's Office	Pocahontas	WV	5	1	200.00	11.47
Polk County Sheriff's Office	Polk	FL	600	13	21.67	2.16
Polk County Sheriff's Office	Polk	GA	27	2	74.07	4.82
Polk County Sheriff's Office	Polk	IA	143	3	20.98	0.70
Portage County Sheriff's Office	Portage	OH	66	1	15.15	0.62
Porter County Sheriff's Office	Porter	IN	61	2	32.79	1.22

Pottawattamie County Sheriff's Office	Pottawattomie	IA	50	1	20.00	1.07
Potter County Sheriff's Office	Potter	TX	93	2	21.51	1.65
Powell County Sheriff's Office	Powell	MT	10	1	100.00	14.23
Prince George's County Sheriff's Office	Prince Georges	MD	233	3	12.88	0.35
Prince William County Sheriff's Office	Prince William	VA	75	1	13.33	0.25
Pulaski County Sheriff's Office	Pulaski	IL	11	2	181.82	32.46
Putnam County Sheriff's Office	Putnam	TN	58	2	34.48	2.77
Queen Anne's County Sheriff's Office	Queen Annes	MD	50	1	20.00	2.09
Ramsey County Sheriff's Office	Ramsey	MN	235	2	8.51	0.39
Randolph County Sheriff's Office	Randolph	IL	13	1	76.92	2.99
Rapides Parish Sheriff's Office	Rapides	LA	212	1	4.72	0.76
Ravalli County Sheriff's Office	Ravalli	MT	29	1	34.48	2.49
Richland County Sheriff's Office	Richland	SC	512	3	5.86	0.78
Richmond (City) Sheriff's Office	Richmond City	VA	424	2	4.72	0.98
Richmond County Sheriff's Office	Richmond	GA	449	5	11.14	2.49
Rio Arriba County Sheriff's Office	Rio Arriba	NM	22	1	45.45	2.48
Riverside County Sheriff's Office	Riverside	CA	2147	11	5.12	0.50
Robeson County Sheriff's Office	Robeson	NC	128	3	23.44	2.24
Rock County Sheriff's Office	Rock	WI	94	2	21.28	1.25
Rockingham County Sheriff's Office	Rockingham	VA	46	1	21.74	1.31
Roosevelt County Sheriff's Office	Roosevelt	MT	11	1	90.91	9.59
Routt County Sheriff's Office	Routt	CO	22	1	45.45	4.25
Russell County Sheriff's Office	Russell	AL	32	2	62.50	3.78
Rutherford County Sheriff's Office	Rutherford	TN	189	2	10.58	0.76
Sacramento County Sheriff's Office	Sacramento	CA	1409	6	4.26	0.42
Saginaw County Sheriff's Office	Saginaw	MI	71	1	14.08	0.50
Salem County Sheriff's Office	Salem	NJ	157	1	6.37	1.51
Saline County Sheriff's Office	Saline	IL	42	1	23.81	4.01
Saline County Sheriff's Office	Saline	KS	44	1	22.73	1.80
San Benito County Sheriff's Office	San Benito	CA	29	1	34.48	1.81
San Bernardino County Sheriff's Office	San Bernardino	CA	1797	11	6.12	0.54
San Diego County Sheriff's Office	San Diego	CA	1322	7	5.30	0.23
San Jacinto County Sheriff's Office	San Jacinto	TX	21	1	47.62	3.79
San Juan County Sheriff's Office	San Juan	NM	94	2	21.28	1.54
San Luis Obispo County Sheriff's Office	San Luis Obispo	CA	156	2	12.82	0.74
Sandoval County Sheriff's Office	Sandoval	NM	45	1	22.22	0.76

Santa Barbara County Sheriff's Office	Santa Barbara	CA	294	1	3.40	0.24
Santa Clara County Sheriff's Office	Santa Clara	CA	450	1	2.22	0.06
Santa Fe County Sheriff's Office	Santa Fe	NM	75	1	13.33	0.69
Santa Rosa County Sheriff's Office	Santa Rosa	FL	190	1	5.26	0.66
Sarasota County Sheriff's Office	Sarasota	FL	409	1	2.44	0.26
Sauk County Sheriff's Office	Sauk	WI	118	1	8.47	1.61
Seminole County Sheriff's Office	Seminole	FL	355	2	5.63	0.47
Seneca County Sheriff's Office	Seneca	NY	23	6	260.87	17.02
Shelby County Sheriff's Office	Shelby	OH	30	1	33.33	2.02
Shelby County Sheriff's Office	Shelby	TN	516	8	15.50	0.86
Simpson County Sheriff's Office	Simpson	KY	11	1	90.91	5.77
Smith County Sheriff's Office	Smith	TX	88	1	11.36	0.48
Snohomish County Sheriff's Office	Snohomish	WA	287	2	6.97	0.28
Socorro County Sheriff's Office	Socorro	NM	10	1	100.00	5.60
Solano County Sheriff's Office	Solano	CA	113	1	8.85	0.24
Spartanburg County Sheriff's Office	Spartanburg	SC	297	2	6.73	0.70
Spokane County Sheriff's Office	Spokane	WA	244	2	8.20	0.42
St. Bernard Parish Sheriff's Office	St. Bernard	LA	189	1	5.29	2.79
St. Charles County Sheriff's Office	St. Charles	MO	153	2	13.07	0.55
St. Charles Parish Sheriff's Office	St. Charles	LA	291	1	3.44	1.89
St. Croix County Sheriff's Office	St. Croix	WI	44	1	22.73	1.19
St. Helena Parish Sheriff's Office	St. Helena	LA	22	1	45.45	8.93
St. John The Baptist Parish Sheriff's Office	St. John the Baptist	LA	150	3	20.00	6.53
St. Joseph County Sheriff's Office	St. Joseph	IN	116	3	25.86	1.12
St. Louis County Sheriff's Office	St. Louis	MO	200	4	20.00	0.40
St. Lucie County Sheriff's Office	St. Lucie	FL	259	2	7.72	0.72
St. Martin Parish Sheriff's Office	St. Martin	LA	45	1	22.22	1.92
St. Mary's County Sheriff's Office	St. Marys	MD	120	1	8.33	0.95
St. Tammany Parish Sheriff's Office	St. Tammany	LA	409	2	4.89	0.86
Stanislaus County Sheriff's Office	Stanislaus	CA	230	1	4.35	0.19
Stanly County Sheriff's Office	Stanly	NC	49	1	20.41	1.65
Stark County Sheriff's Office	Stark	ND	11	1	90.91	4.13
Starr County Sheriff's Office	Starr	TX	31	1	32.26	1.64
Stephens County Sheriff's Office	Stephens	GA	31	1	32.26	3.82
Stephens County Sheriff's Office	Stephens	OK	11	2	181.82	4.44
Steuben County Sheriff's Office	Steuben	NY	26	1	38.46	1.01

Sullivan County Sheriff's Office	Sullivan	NY	44	1	22.73	1.29
Sullivan County Sheriff's Office	Sullivan	TN	183	1	5.46	0.64
Summit County Sheriff's Office	Summit	OH	393	1	2.54	0.18
Sutter County Sheriff's Office	Sutter	CA	105	1	9.52	1.06
Talbot County Sheriff's Office	Talbot	GA	8	3	375.00	43.70
Terrebonne Parish Sheriff's Office	Terrebonne	LA	300	2	6.67	1.79
Terrell County Sheriff's Office	Terrell	TX	5	1	200.00	101.63
Thomas County Sheriff's Office	Thomas	GA	47	2	42.55	4.47
Towns County Sheriff's Office	Towns	GA	18	1	55.56	9.55
Tulare County Sheriff's Office	Tulare	CA	513	3	5.85	0.68
Tuscola County Sheriff's Office	Tuscola	MI	25	1	40.00	1.79
Ulster County Sheriff's Office	Ulster	NY	57	1	17.54	0.55
Union County Sheriff's Office	Union	IN	6	1	166.67	13.30
Union County Sheriff's Office	Union	NC	170	1	5.88	0.50
Upshur County Sheriff's Office	Upshur	TX	45	1	22.22	2.54
Valencia County Sheriff's Office	Valencia	NM	37	1	27.03	1.31
Ventura County Sheriff's Office	Ventura	CA	755	1	1.32	0.12
Vernon Parish Sheriff's Office	Vernon	LA	64	2	31.25	3.82
Vigo County Sheriff's Office	Vigo	IN	38	1	26.32	0.93
Volusia County Sheriff's Office	Volusia	FL	450	4	8.89	0.81
Wake County Sheriff's Office	Wake	NC	354	4	11.30	0.44
Walker County Sheriff's Office	Walker	GA	80	2	25.00	2.91
Walton County Sheriff's Office	Walton	FL	165	4	24.24	7.27
Warren County Sheriff's Office	Warren	NC	30	1	33.33	4.77
Washington County Sheriff's Office	Washington	MD	94	1	10.64	0.68
Washington County Sheriff's Office	Washington	TN	86	1	11.63	0.81
Washoe County Sheriff's Office	Washoe	NV	414	4	9.66	0.95
Washtenaw County Sheriff's Office	Washtenaw	MI	133	4	30.08	1.16
Waukesha County Sheriff's Office	Waukesha	WI	150	1	6.67	0.26
Wayne County Sheriff's Office	Wayne	MI	1062	1	0.94	0.05
Wayne County Sheriff's Office	Wayne	NC	85	2	23.53	1.63
Weld County Sheriff's Office	Weld	CO	121	1	8.26	0.40
Westmoreland County Sheriff's Office	Westmoreland	PA	0	1		0.27
White County Sheriff's Office	White	GA	40	1	25.00	3.68
White County Sheriff's Office	White	TN	28	1	35.71	3.87
Whitfield County Sheriff's Office	Whitfield	GA	115	1	8.70	0.97

Whitley County Sheriff's Office	Whitley	KY	12	1	83.33	2.81
Wicomico County Sheriff's Office	Wicomico	MD	0	1		1.01
Will County Sheriff's Office	Will	IL	445	1	2.25	0.15
Williamson County Sheriff's Office	Williamson	IL	29	2	68.97	3.01
Williamson County Sheriff's Office	Williamson	TN	99	2	20.20	1.09
Williamson County Sheriff's Office	Williamson	TX	206	2	9.71	0.47
Wilson County Sheriff's Office	Wilson	TN	202	1	4.95	0.88
Winkler County Sheriff's Office	Winkler	TX	10	1	100.00	14.06
Winn Parish Sheriff's Office	Winn	LA	23	1	43.48	6.53
Winnebago County Sheriff's Office	Winnebago	IL	142	1	7.04	0.34
Wood County Sheriff's Office	Wood	WV	40	1	25.00	1.15
Woodford County Sheriff's Office	Woodford	IL	37	1	27.03	2.59
Woodruff County Sheriff's Office	Woodruff	AR	6	1	166.67	13.77
Yakima County Sheriff's Office	Yakima	WA	69	2	28.99	0.82
Yamhill County Sheriff's Office	Yamhill	OR	36	1	27.78	1.01
Yellowstone County Sheriff's Office	Yellowstone	MT	55	1	18.18	0.68
Zapata County Sheriff's Office	Zapata	TX	44	1	22.73	7.13

Table 82. County Police Departments in Study: Rates of Officers Arrested, 2005-2011 (Sorted Alphabetically)

Agency	County	State	# of Full-Time Sworn Personnel	Per Agency	Per 1,000 Officers	Per 100,000 Population
Allegheny County Police Department.	Allegheny	PA	202	2	9.90	0.16
Anne Arundel County Police Department	Anne Arundel	MD	633	3	4.74	0.56
Arlington County Police Department	Arlington	VA	364	1	2.75	0.48
Athens-Clarke County Police Dept	Clarke	GA	213	2	9.39	1.71
Baltimore County Police Department	Baltimore	MD	1910	4	2.09	0.50
Charlotte - Mecklenburg Police Department	Mecklenburg	NC	1672	20	11.96	2.17
Chesterfield County Police Department	Chesterfield	VA	475	1	2.11	0.32
Clayton County Police Department	Clayton	GA	336	3	8.93	1.16
Cobb County Police Department	Cobb	GA	590	5	8.47	0.73
DeKalb County Police Department	DeKalb	GA	1074	13	12.10	1.88
Dougherty County Police Dept.	Dougherty	GA	47	2	42.55	2.11
Fairfax County Police Department	Fairfax	VA	1419	7	4.93	0.65
Floyd County Police Department	Floyd	GA	71	1	14.08	1.04
Fulton County Police Department	Fulton	GA	129	2	15.50	0.22
Gaston County Police Department	Gaston	NC	133	2	15.04	0.97
Gwinnett County Police Department	Gwinnett	GA	682	4	5.87	0.50
Henrico County Division of Police	Henrico	VA	554	4	7.22	1.30
Henry County Police Department	Henry	GA	225	1	4.44	0.49
Honolulu (City and County) Police Department	Honolulu	HI	1934	26	13.44	2.73
Horry County Police Department	Horry	SC	243	9	37.04	3.34
Howard County Police Department	Howard	MD	424	3	7.08	1.04
Indianapolis Police	Marion	IN	1582	33	20.86	3.65
James City County Police Dept.	James City	VA	94	1	10.64	1.49
Kauai (County) Police Department	Kauai	HI	125	3	24.00	4.47
Maui (County) Police Department	Maui	HI	329	5	15.20	3.23
Miami-Dade (County) Police Department	Miami-Dade	FL	3093	25	8.08	1.00
Montgomery County Police Department	Montgomery	MD	1206	16	13.27	1.65
Nassau County Police Department	Nassau	NY	2732	6	2.20	0.45
New Castle County Police Department	New Castle	DE	358	2	5.59	0.37
Oldham County Police Department	Oldham	KY	31	2	64.52	3.32
Polk County Police Department	Polk	GA	35	3	85.71	7.23

Prince George's County Police Department	Prince Georges	MD	1578	19	12.04	2.20
Prince William County Police Department	Prince William	VA	546	3	5.49	0.75
Riley County Police Department	Riley	KS	101	1	9.90	1.41
Roanoke County Police Department	Roanoke	VA	135	2	14.81	2.17
Savannah-Chatham Metropolitan Police Department	Chatham	GA	534	6	11.24	2.26
St. Louis County Police Dept	St. Louis	MO	781	2	2.56	0.20
Suffolk County Police Department	Suffolk	NY	2622	6	2.29	0.40
Westchester County Department of Public Safety	Westchester	NY	270	3	11.11	0.32

Table 83. 500 Largest Municipal Police Departments in Study: Rates of Officers Arrested, 2005-2011 (Sorted Alphabetically by Agency Name)

Agency	County	State	# of Full-Time Sworn Personnel	Per Agency	Per 1,000 Officers	Per 100,000 Population
Akron Police Department	Summit	OH	472	8	16.95	1.48
Alameda Police Department	Alameda	CA	94	2	21.28	0.13
Albany Police Department	Dougherty	GA	184	4	21.74	4.23
Albany Police Department	Albany	NY	328	7	21.34	2.30
Albuquerque Police Department	Bernalillo	NM	1020	13	12.75	1.96
Alexandria Police Department	Alexandria City	VA	315	3	9.52	2.14
Alhambra Police Department	Los Angeles	CA	83	1	12.05	0.01
Allen Police Department	Collin	TX	106	2	18.87	0.26
Allentown Police Department	Lehigh	PA	200	1	5.00	0.29
Altamonte Springs Police Dept	Seminole	FL	124	1	8.06	0.24
Anaheim Police Department	Orange	CA	398	3	7.54	0.10
Anchorage Police Department	Anchorage	AK	372	4	10.75	1.37
Anderson Police	Madison	IN	117	4	34.19	3.04
Anderson Police Department	Anderson	SC	91	3	32.97	1.60
Ann Arbor Police Department	Washtenaw	MI	160	4	25.00	1.16
Apopka Police Department	Orange	FL	85	1	11.76	0.09
Arlington Police Department	Tarrant	TX	610	3	4.92	0.17
Atlanta Police Department	Fulton	GA	1719	22	12.80	2.39
Aurora Police Department	Arapahoe	CO	627	6	9.57	1.05
Austin Police Department	Travis	TX	1515	10	6.60	0.98
Bakersfield Police Department	Kern	CA	348	8	22.99	0.95
Baltimore Police Department	Baltimore City	MD	2990	55	18.39	8.86
Barnstable Police Department	Barnstable	MA	110	2	18.18	0.93
Bartlett Police Department	Shelby	TN	105	1	9.52	0.11
Baton Rouge Police Department	East Baton Rouge	LA	630	6	9.52	1.36
Baytown Police Department	Harris	TX	136	1	7.35	0.02
Beaumont Police Department	Jefferson	TX	246	2	8.13	0.79
Beaverton Police Department	Washington	OR	124	1	8.06	0.19
Belleville Police Dept	St. Clair	IL	81	1	12.35	0.37
Bellevue Police Dept	Sarpy	NE	92	1	10.87	0.63
Bend Police Department	Deschutes	OR	86	2	23.26	1.27

Bensalem Township Police Dept	Bucks	PA	104	1	9.62	0.16
Berkeley Police Department	Alameda	CA	186	1	5.38	0.07
Berwyn Police Dept	Cook	IL	105	3	28.57	0.06
Bethlehem Police Department	Northampton	PA	154	4	25.97	1.34
Billings Police Department	Yellowstone	MT	138	2	14.49	1.35
Biloxi Police Department	Harrison	MS	133	2	15.04	1.07
Binghamton Police Department	Broome	NY	139	1	7.19	0.50
Birmingham Police Department	Jefferson	AL	816	8	9.80	1.21
Bloomington Police Dept	McLean	IL	122	2	16.39	1.18
Boise Police Department	Ada	ID	306	2	6.54	0.51
Bolingbrook Police Dept	Will	IL	122	3	24.59	0.44
Bossier City Police Dept	Bossier	LA	178	3	16.85	2.56
Boston Police Department	Suffolk	MA	2181	14	6.42	1.94
Boulder Police Department	Boulder	CO	165	1	6.06	0.34
Boynton Beach Police Department	Palm Beach	FL	165	7	42.42	0.53
Brick Township Police	Ocean	NJ	127	1	7.87	0.17
Bridgeport Police Department	Fairfield	CT	422	3	7.11	0.33
Bristol Police Department	Hartford	CT	119	1	8.40	0.11
Brockton Police Department	Plymouth	MA	197	3	15.23	0.61
Broken Arrow Police Department	Tulsa	OK	124	2	16.13	0.33
Brookline Police Department	Norfolk	MA	129	3	23.26	0.45
Broomfield Police Department	Broomfield	CO	105	1	9.52	1.79
Brownsville Police Department	Cameron	TX	230	1	4.35	0.25
Buffalo Police Department	Erie	NY	793	4	5.04	0.44
Burlington Police Department	Alamance	NC	105	3	28.57	1.99
Calumet City Police Dept	Cook	IL	91	1	10.99	0.02
Cambridge Police Department	Middlesex	MA	272	1	3.68	0.07
Camden Police	Camden	NJ	397	10	25.19	1.95
Canton Police Department	Stark	OH	172	1	5.81	0.27
Cape Coral Police Department	Lee	FL	220	2	9.09	0.32
Carmel Police	Hamilton	IN	104	3	28.85	1.09
Cedar Rapids Police Department	Linn	IA	197	2	10.15	0.95
Champaign Police Dept	Champaign	IL	122	1	8.20	0.50
Chandler Police Department	Maricopa	AZ	333	2	6.01	0.05
Charleston Police Department	Kanawha	WV	182	9	49.45	4.66
Charleston Police Department	Charleston	SC	382	2	5.24	0.57

Charlottesville Police Dept.	Charlottesville City	VA	115	1	8.70	2.30
Chattanooga Police Department	Hamilton	TN	434	14	32.26	4.16
Chelsea Police Department	Suffolk	MA	92	1	10.87	0.14
Cherry Hill Police	Camden	NJ	145	2	13.79	0.39
Chesapeake Police Department	Chesapeake City	VA	376	3	7.98	1.35
Chicago Police Dept	Cook	IL	13354	83	6.22	1.60
Chico Police Department	Butte	CA	88	2	22.73	0.91
Chicopee Police Department	Hampden	MA	133	1	7.52	0.22
Chula Vista Police Department	San Diego	CA	244	1	4.10	0.03
Cicero Police Dept	Cook	IL	146	4	27.40	0.08
Cincinnati Police Department	Hamilton	OH	1082	10	9.24	1.25
Citrus Heights Police Department	Sacramento	CA	83	1	12.05	0.07
Clarksville Police Department	Montgomery	TN	238	5	21.01	7.54
Clearwater Police Department	Pinellas	FL	255	1	3.92	0.11
Cleveland Police Department	Bradley	TN	89	4	44.94	4.04
Cleveland Police Department	Cuyahoga	OH	1616	27	16.71	2.11
Clifton Police	Passaic	NJ	158	1	6.33	0.20
Coconut Creek Police Department	Broward	FL	89	3	33.71	0.17
College Park Police Department	Fulton	GA	93	1	10.75	0.11
Colonie Town Police Department	Albany	NY	109	2	18.35	0.66
Colorado Springs Police Department	El Paso	CO	668	5	7.49	0.80
Columbia Police Department	Richland	SC	351	8	22.79	2.08
Columbia Police Department	Boone	MO	155	1	6.45	0.61
Columbus Police Department	Muscogee	GA	400	6	15.00	3.16
Columbus Police Department	Franklin	OH	1886	9	4.77	0.77
Concord Police Department	Cabarrus	NC	153	1	6.54	0.56
Concord Police Department	Contra Costa	CA	161	1	6.21	0.10
Conroe Police Department	Montgomery	TX	99	2	20.20	0.44
Coral Gables Police Department	Miami-Dade	FL	184	2	10.87	0.08
Corpus Christi Police Department	Nueces	TX	448	3	6.70	0.88
Costa Mesa Police Department	Orange	CA	158	1	6.33	0.03
Council Bluffs Police Department	Pottawattomie	IA	105	1	9.52	1.07
Covington Police Department	Kenton	KY	112	1	8.93	0.63
Cranston Police Department	Providence	RI	148	3	20.27	1.81
Cuyahoga Falls Police Department	Summit	OH	86	2	23.26	0.37
Dallas Police Department	Dallas	TX	3389	39	11.51	1.65

Daly City Police Department	San Mateo	CA	113	1	8.85	0.14
Danbury Police Department	Fairfield	CT	153	1	6.54	0.11
Danville Police Department	Pittsylvania	VA	126	1	7.94	1.57
Davie Police Department	Broward	FL	164	2	12.20	0.11
Dayton Police Department	Montgomery	OH	421	1	2.38	0.19
Daytona Beach Police Department	Volusia	FL	250	6	24.00	1.21
Dearborn Police Department	Wayne	MI	198	4	20.20	0.22
Decatur Police Department	Morgan	AL	133	1	7.52	0.84
Decatur Police Dept	Macon	IL	166	1	6.02	0.90
Delray Beach Police Department	Palm Beach	FL	152	1	6.58	0.08
Denton Police Department	Denton	TX	155	1	6.45	0.15
Denver Police Department	Denver	CO	1525	13	8.52	2.17
Des Moines Police Department	Polk	IA	385	6	15.58	1.39
Des Plaines Police Dept	Cook	IL	102	1	9.80	0.02
Detroit Police Department	Wayne	MI	2250	23	10.22	1.26
Dothan Police Department	Houston	AL	148	2	13.51	1.97
Dover Police Department	Kent	DE	90	2	22.22	1.23
Downers Grove Police Dept	Du Page	IL	81	1	12.35	0.11
Dubuque Police Department	Dubuque	IA	100	3	30.00	3.20
Durham Police Department	Durham	NC	494	9	18.22	3.36
East Chicago Police	Lake	IN	110	2	18.18	0.40
East Orange Police	Essex	NJ	283	3	10.60	0.38
East Point Police Department	Fulton	GA	116	2	17.24	0.22
East Providence Police Department	Providence	RI	98	1	10.20	0.16
Eau Claire Police Department	Eau Claire	WI	96	1	10.42	1.01
Edinburg Police Department	Hidalgo	TX	110	5	45.45	0.65
Edison Police	Middlesex	NJ	189	7	37.04	0.86
Edmond Police Department	Oklahoma	OK	110	2	18.18	0.28
Egg Harbor Township Police	Atlantic	NJ	95	2	21.05	0.73
El Cajon Police Department	San Diego	CA	120	1	8.33	0.03
El Paso Police Department	El Paso	TX	1132	15	13.25	1.87
Elgin Police Dept	Kane	IL	181	5	27.62	0.97
Elizabeth Police	Union	NJ	348	1	2.87	0.19
Elk Grove Police Department	Sacramento	CA	126	1	7.94	0.38
Elkhart Police	Elkhart	IN	124	4	32.26	2.02
Elyria Police Department	Lorain	OH	86	2	23.26	0.66

Enfield Police Department	Hartford	CT	95	4	42.11	0.45
Erie Police Department	Erie	PA	167	1	5.99	0.36
Euclid Police Department	Cuyahoga	OH	100	1	10.00	0.08
Eules Police Department	Tarrant	TX	83	1	12.05	0.06
Evansville Police	Vanderburgh	IN	277	3	10.83	1.67
Everett Police Department	Snohomish	WA	198	1	5.05	0.14
Fall River Police Department	Bristol	MA	237	1	4.22	0.18
Farmington Police Department	San Juan	NM	129	5	38.76	3.84
Fayetteville Police Department	Washington	AR	117	2	17.09	0.98
Fayetteville Police Department	Cumberland	NC	341	2	5.87	0.63
Federal Way Police Department	King	WA	133	1	7.52	0.05
Flagstaff Police Department	Coconino	AZ	113	1	8.85	0.74
Flint Police Department	Genesee	MI	204	6	29.41	1.41
Florence Police Department	Florence	SC	109	2	18.35	1.46
Florence Police Department	Lauderdale	AL	94	1	10.64	1.08
Folsom Police Department	Sacramento	CA	88	2	22.73	0.14
Fort Collins Police Department	Larimer	CO	162	3	18.52	1.00
Fort Lauderdale Police Department	Broward	FL	482	6	12.45	0.34
Fort Myers Police Department	Lee	FL	170	4	23.53	0.65
Fort Pierce Police Department	St. Lucie	FL	126	4	31.75	1.44
Fort Smith Police Department	Sebastian	AR	158	3	18.99	2.39
Fort Wayne Police	Allen	IN	447	4	8.95	1.13
Fort Worth Police Department	Tarrant	TX	1489	20	13.43	1.11
Framingham Police Department	Middlesex	MA	118	1	8.47	0.07
Frederick Police Department	Frederick	MD	138	1	7.25	0.43
Fremont Police Department	Alameda	CA	182	1	5.49	0.07
Fresno Police Department	Fresno	CA	828	7	8.45	0.75
Fullerton Police Department	Orange	CA	159	3	18.87	0.10
Gainesville Police Department	Alachua	FL	275	4	14.55	1.62
Galveston Police Department	Galveston	TX	161	1	6.21	0.34
Garden Grove Police Department	Orange	CA	166	2	12.05	0.07
Gary Police	Lake	IN	243	10	41.15	2.02
Gastonia Police Department	Gaston	NC	166	2	12.05	0.97
Glendale Police Department	Los Angeles	CA	264	1	3.79	0.01
Gloucester Township Police	Camden	NJ	111	2	18.02	0.39
Goldsboro Police Department	Wayne	NC	101	1	9.90	0.82

Grand Junction Police Department	Mesa	CO	108	2	18.52	1.36
Grand Rapids Police Department	Kent	MI	319	1	3.13	0.17
Grapevine Police Department	Tarrant	TX	90	1	11.11	0.06
Greece Town Police Department	Monroe	NY	94	4	42.55	0.54
Greeley Police Department	Weld	CO	146	2	13.70	0.79
Greensboro Police Department	Guilford	NC	593	5	8.43	1.02
Greenville Police Department	Greenville	SC	178	4	22.47	0.89
Greenville Police Department	Washington	MS	96	2	20.83	3.91
Gresham Police Department	Multnomah	OR	129	1	7.75	0.14
Gulfport Police Department	Harrison	MS	193	1	5.18	0.53
Hackensack Police	Bergen	NJ	117	9	76.92	0.99
Hagerstown Police Department	Washington	MD	105	1	9.52	0.68
Hamden Police Department	New Haven	CT	105	2	19.05	0.23
Hamilton Police Department	Butler	OH	135	1	7.41	0.27
Hampton Police Department	Hampton City	VA	232	2	8.62	1.46
Harlingen Police Department	Cameron	TX	123	1	8.13	0.25
Harrisburg Police Department	Dauphin	PA	155	1	6.45	0.37
Hartford Police Department	Hartford	CT	408	10	24.51	1.12
Hattiesburg Police Department	Forrest	MS	126	2	15.87	2.67
Haverhill Police Department	Essex	MA	93	1	10.75	0.13
Hayward Police Department	Alameda	CA	185	1	5.41	0.07
Hempstead Village Police Department	Nassau	NY	112	1	8.93	0.07
Henderson Police Department	Clark	NV	336	2	5.95	0.10
Hialeah Police Department	Miami-Dade	FL	338	1	2.96	0.04
Hickory Police Department	Catawba	NC	114	1	8.77	0.65
Hoboken Police	Hudson	NJ	156	3	19.23	0.47
Hollywood Police Department	Broward	FL	316	8	25.32	0.46
Holyoke Police Department	Hampden	MA	123	1	8.13	0.22
Homestead Police Department	Miami-Dade	FL	106	3	28.30	0.12
Houston Police Department	Harris	TX	5053	35	6.93	0.86
Huntington Beach Police Department	Orange	CA	223	1	4.48	0.03
Huntsville Police Department	Madison	AL	405	3	7.41	0.90
Idaho Falls Police Department	Bonneville	ID	89	1	11.24	0.96
Independence Police Department	Jackson	MO	206	1	4.85	0.15
Inglewood Police Department	Los Angeles	CA	187	1	5.35	0.01
Irvine Police Department	Orange	CA	197	1	5.08	0.03

Irving Police Department	Dallas	TX	344	2	5.81	0.08
Irvington Police	Essex	NJ	190	2	10.53	0.26
Jackson Police Department	Madison	TN	204	4	19.61	4.07
Jackson Police Department	Hinds	MS	480	9	18.75	3.67
Jacksonville Sheriff's Office	Duval	FL	1662	12	7.22	1.39
Jefferson City Police Department	Cole	MO	88	1	11.36	1.32
Jersey City Police	Hudson	NJ	900	12	13.33	1.89
Johnson City Police Department	Washington	TN	146	1	6.85	0.81
Joliet Police Dept	Will	IL	302	3	9.93	0.44
Joplin Police Department	Jasper	MO	92	1	10.87	0.85
Jupiter Police Department	Palm Beach	FL	102	1	9.80	0.08
Kalamazoo Dept of Public Safety	Kalamazoo	MI	244	1	4.10	0.40
Kansas City Police Department	Wyandotte	KS	354	10	28.25	6.35
Kansas City Police Department	Jackson	MO	1421	5	3.52	0.74
Kenner Police Department	Jefferson	LA	162	1	6.17	0.23
Kennewick Police Department	Benton	WA	90	1	11.11	0.57
Killeen Police Department	Bell	TX	190	3	15.79	0.97
Kingsport Police Department	Sullivan	TN	111	3	27.03	1.91
Kissimmee Police Department	Osceola	FL	136	3	22.06	1.12
Kokomo Police	Howard	IN	100	1	10.00	1.21
Lafayette Police	Tippecanoe	IN	128	1	7.81	0.58
Lafayette Police Department	Lafayette	LA	243	1	4.12	0.45
LaGrange Police Department	Troup	GA	83	1	12.05	1.49
Lake Charles Police Department	Calcasieu	LA	153	2	13.07	1.04
Lakeland Police Department	Polk	FL	226	5	22.12	0.83
Lakewood Police Department	Pierce	WA	103	1	9.71	0.13
Lancaster Police Department	Lancaster	PA	161	2	12.42	0.39
Lansing Police Department	Ingham	MI	240	3	12.50	1.07
Laredo Police Department	Webb	TX	430	4	9.30	1.60
Largo Police Department	Pinellas	FL	140	1	7.14	0.11
Las Cruces Police Department	Dona Ana	NM	167	1	5.99	0.48
Las Vegas Metro Police Department	Clark	NV	2942	8	2.72	0.41
Lauderhill Police Department	Broward	FL	115	1	8.70	0.06
Lawrence Police Department	Essex	MA	151	4	26.49	0.54
Lawton Police Department	Comanche	OK	165	1	6.06	0.81
Lincoln Police Dept	Lancaster	NE	308	1	3.25	0.35

Little Rock Police Department	Pulaski	AR	520	2	3.85	0.52
Long Beach Police Department	Los Angeles	CA	968	4	4.13	0.04
Longmont Police Department	Boulder	CO	136	1	7.35	0.34
Lorain Police Department	Lorain	OH	100	5	50.00	1.66
Los Angeles Police Department	Los Angeles	CA	9727	30	3.08	0.31
Louisville Metro Police Department	Jefferson	KY	1197	16	13.37	2.16
Lowell Police Department	Middlesex	MA	239	2	8.37	0.13
Lubbock Police Department	Lubbock	TX	376	5	13.30	1.79
Lynn Police Department	Essex	MA	178	2	11.24	0.27
Macon Police Department	Bibb	GA	270	9	33.33	5.79
Madison Police Department	Dane	WI	437	1	2.29	0.20
Manchester Police Department	Hartford	CT	116	2	17.24	0.22
Manchester Police Department	Hillsborough	NH	218	1	4.59	0.25
Marietta Police Department	Cobb	GA	133	1	7.52	0.15
McAllen Police Department	Hidalgo	TX	273	3	10.99	0.39
Medford Police Department	Jackson	OR	103	2	19.42	0.98
Medford Police Department	Middlesex	MA	110	1	9.09	0.07
Melbourne Police Department	Brevard	FL	163	1	6.13	0.18
Memphis Police Department	Shelby	TN	1549	46	29.70	4.96
Mentor Police Department	Lake	OH	82	1	12.20	0.43
Merced Police Department	Merced	CA	105	1	9.52	0.39
Meriden Police Department	New Haven	CT	113	1	8.85	0.12
Meridian Police Department	Lauderdale	MS	99	3	30.30	3.74
Mesa Police Department	Maricopa	AZ	831	2	2.41	0.05
Mesquite Police Department	Dallas	TX	226	1	4.42	0.04
Miami Beach Police Department	Miami-Dade	FL	374	3	8.02	0.12
Miami Police Department	Miami-Dade	FL	1104	14	12.68	0.56
Michigan City Police	La Porte	IN	86	1	11.63	0.90
Middletown Police Department	Middlesex	CT	99	2	20.20	1.21
Midland Police Department	Midland	TX	153	1	6.54	0.73
Milford Police Department	New Haven	CT	110	1	9.09	0.12
Milwaukee Police Department	Milwaukee	WI	1987	73	36.74	7.70
Minneapolis Police Department	Hennepin	MN	902	18	19.96	1.56
Miramar Police Department	Broward	FL	171	2	11.70	0.11
Mission Police Department	Hidalgo	TX	125	2	16.00	0.26
Missoula Police Department	Missoula	MT	100	1	10.00	0.91

Mobile Police Department	Mobile	AL	515	4	7.77	0.97
Modesto Police Department	Stanislaus	CA	262	5	19.08	0.97
Moline Police Department	Rock Island	IL	85	1	11.76	0.68
Monroe Police Department	Ouachita	LA	188	1	5.32	0.65
Montgomery Police Department	Montgomery	AL	500	6	12.00	2.62
Mount Pleasant Police Department	Charleston	SC	137	1	7.30	0.29
Mount Vernon Police Department	Westchester	NY	205	1	4.88	0.11
Muncie Police	Delaware	IN	102	3	29.41	2.55
Murfreesboro Police Department	Rutherford	TN	213	5	23.47	1.90
Muskogee Police Department	Muskogee	OK	90	4	44.44	5.63
Myrtle Beach Police Department	Horry	SC	179	5	27.93	1.86
Naperville Police Dept	Du Page	IL	184	1	5.43	0.11
Nashua Police Department	Hillsborough	NH	172	1	5.81	0.25
Nashville Metro Police Department	Davidson	TN	1315	18	13.69	2.87
New Bedford Police Department	Bristol	MA	288	2	6.94	0.36
New Bern Police Department	Craven	NC	90	1	11.11	0.97
New Braunfels Police Department	Comal	TX	92	2	21.74	1.84
New Britain Police Department	Hartford	CT	160	2	12.50	0.22
New Brunswick Police	Middlesex	NJ	138	2	14.49	0.25
New Haven Police Department	New Haven	CT	436	8	18.35	0.93
New London Police Department	New London	CT	90	2	22.22	0.73
New Orleans Police Department	Orleans	LA	1425	63	44.21	18.32
New Rochelle Police Department	Westchester	NY	185	2	10.81	0.21
New York City Police Department	New York	NY	36023	196	5.44	2.40
Newark Police	Essex	NJ	1310	8	6.11	1.02
Newburgh City Police Department	Orange	NY	105	1	9.52	0.27
Newport Beach Police Department	Orange	CA	140	1	7.14	0.03
Newport News Police Department	Newport News City	VA	415	10	24.10	5.53
Newton Police Department	Middlesex	MA	136	1	7.35	0.07
Niagara Falls Police Department	Niagara	NY	145	3	20.69	1.39
Norfolk Police Department	Norfolk City	VA	772	14	18.13	5.77
North Bergen Police	Hudson	NJ	123	1	8.13	0.16
North Brunswick Police	Middlesex	NJ	83	1	12.05	0.12
North Charleston Police Department	Charleston	SC	325	5	15.38	1.43
North Las Vegas Police Department	Clark	NV	471	2	4.25	0.10
Norwalk Police Department	Fairfield	CT	167	5	29.94	0.55

Norwich Police Department	New London	CT	81	5	61.73	1.82
Oak Lawn Police Dept	Cook	IL	106	1	9.43	0.02
Oak Park Police Dept	Cook	IL	115	1	8.70	0.02
Oakland Police Department	Alameda	CA	773	3	3.88	0.20
Ocala Police Department	Marion	FL	155	2	12.90	0.60
Ocean City Police Department	Worcester	MD	107	1	9.35	1.94
Oceanside Police Department	San Diego	CA	210	4	19.05	0.13
O'Fallon Police Department	St. Charles	MO	107	1	9.35	0.28
Ogden Police Department	Weber	UT	137	2	14.60	0.86
Oklahoma City Police Department	Oklahoma	OK	1046	12	11.47	1.67
Olathe Police Department	Johnson	KS	161	1	6.21	0.18
Omaha Police Dept	Douglas	NE	747	6	8.03	1.16
Orangetown Town Police Department	Rockland	NY	90	1	11.11	0.32
Orem Department of Public Safety	Utah	UT	90	1	11.11	0.19
Orlando Police Department	Orange	FL	757	8	10.57	0.70
Oro Valley Police Department	Pima	AZ	103	1	9.71	0.10
Ottawa County Sheriff's Office	Ottawa	MI	115	1	8.70	0.38
Oxnard Police Department	Ventura	CA	228	3	13.16	0.36
Palm Bay Police Department	Brevard	FL	159	1	6.29	0.18
Palm Beach Gardens Police Department	Palm Beach	FL	114	2	17.54	0.15
Palm Springs Police Department	Riverside	CA	93	1	10.75	0.05
Palo Alto Police Department	Santa Clara	CA	93	1	10.75	0.06
Panama City Police Department	Bay	FL	86	1	11.63	0.59
Parma Police Department	Cuyahoga	OH	92	3	32.61	0.23
Pasadena Police Department	Harris	TX	260	5	19.23	0.12
Paterson Police	Passaic	NJ	497	3	6.04	0.60
Pawtucket Police Department	Providence	RI	153	2	13.07	0.32
Pembroke Pines Police Department	Broward	FL	238	1	4.20	0.06
Pensacola Police Department	Escambia	FL	146	1	6.85	0.34
Peoria Police Department	Maricopa	AZ	189	1	5.29	0.03
Peoria Police Dept	Peoria	IL	246	1	4.07	0.54
Petersburg Police Department	Petersburg City	VA	82	2	24.39	6.17
Pharr Police Department	Hidalgo	TX	96	2	20.83	0.26
Philadelphia Police Department	Philadelphia	PA	6624	66	9.96	4.33
Phoenix Police Department	Maricopa	AZ	3388	17	5.02	0.45
Pine Bluff Police Department	Jefferson	AR	140	1	7.14	1.29

Pinellas Park Police Department	Pinellas	FL	99	2	20.20	0.22
Piscataway Township Police	Middlesex	NJ	90	1	11.11	0.12
Pittsburgh Police Department	Allegheny	PA	891	21	23.57	1.72
Plainfield Police Department	Union	NJ	151	5	33.11	0.93
Plano Police Department	Collin	TX	343	1	2.92	0.13
Pleasanton Police Department	Alameda	CA	85	1	11.76	0.07
Port Orange Police Department	Volusia	FL	83	2	24.10	0.40
Port St. Lucie Police Department	St. Lucie	FL	245	1	4.08	0.36
Portland Police Bureau	Multnomah	OR	928	10	10.78	1.36
Portland Police Department	Cumberland	ME	159	3	18.87	1.07
Portsmouth Police Department	Portsmouth City	VA	235	10	42.55	10.47
Poughkeepsie Police Department	Dutchess	NY	105	1	9.52	0.34
Providence Police Department	Providence	RI	483	7	14.49	1.12
Provo Police Department	Utah	UT	99	3	30.30	0.58
Pueblo Police Dept	Pueblo	CO	195	4	20.51	2.51
Quincy Police Department	Norfolk	MA	205	1	4.88	0.15
Racine Police Department	Racine	WI	195	1	5.13	0.51
Raleigh Police Department	Wake	NC	702	8	11.40	0.89
Ramapo Town Police Department	Rockland	NY	120	1	8.33	0.32
Rapid City Police Department	Pennington	SD	107	2	18.69	1.98
Redding Police Department	Shasta	CA	118	1	8.47	0.56
Redondo Beach Police Department	Los Angeles	CA	99	1	10.10	0.01
Reno Police Department	Washoe	NV	362	3	8.29	0.71
Revere Police Department	Suffolk	MA	86	1	11.63	0.14
Richmond Police Department	Contra Costa	CA	165	3	18.18	0.29
Richmond Police Department	Richmond City	VA	752	7	9.31	3.43
Riverside Police Department	Riverside	CA	385	4	10.39	0.18
Riviera Beach Police Department	Palm Beach	FL	108	6	55.56	0.45
Roanoke City Police Department	Roanoke City	VA	264	2	7.58	2.06
Rochester Police Department	Olmsted	MN	125	1	8.00	0.69
Rochester Police Department	Monroe	NY	703	3	4.27	0.40
Rock Hill Police Department	York	SC	121	1	8.26	0.44
Rockford Police Dept	Winnebago	IL	300	1	3.33	0.34
Rocky Mount Police Department	Nash	NC	143	1	6.99	1.77
Rogers Police Department	Benton	AR	99	1	10.10	0.45
Round Rock Police Department	Williamson	TX	133	1	7.52	0.24

Royal Oak Police Department	Oakland	MI	85	1	11.76	0.08
Sacramento Police Department	Sacramento	CA	701	5	7.13	0.35
Saginaw Police Department	Saginaw	MI	92	1	10.87	0.50
Salem Police Department	Essex	MA	83	2	24.10	0.27
Salem Police Department	Marion	OR	187	1	5.35	0.32
Salinas Police Department	Monterey	CA	177	4	22.60	0.96
Salisbury Police Department	Rowan	NC	86	1	11.63	0.72
Salisbury Police Department	Wicomico	MD	88	1	11.36	1.01
Salt Lake City Police Department	Salt Lake	UT	433	1	2.31	0.10
Salt Lake County Sheriff's Office	Salt Lake	UT	342	1	2.92	0.10
San Antonio Police Department	Bexar	TX	2020	30	14.85	1.75
San Bernardino Police Department	San Bernardino	CA	345	2	5.80	0.10
San Diego Police Department	San Diego	CA	1951	12	6.15	0.39
San Francisco Police Department	San Francisco	CA	1940	7	3.61	0.87
San Jose Police Department	Santa Clara	CA	1382	9	6.51	0.51
San Leandro Police Department	Alameda	CA	95	2	21.05	0.13
San Marcos Police Department	Hays	TX	95	1	10.53	0.64
Sandy Police Department	Salt Lake	UT	110	1	9.09	0.10
Sandy Springs Police Department	Fulton	GA	120	3	25.00	0.33
Sanford Police Department	Lee	NC	81	1	12.35	1.73
Sanford Police Department	Seminole	FL	131	1	7.63	0.24
Santa Barbara Police Department	Santa Barbara	CA	136	1	7.35	0.24
Santa Clara Police Department	Santa Clara	CA	141	2	14.18	0.11
Santa Fe Police Department	Santa Fe	NM	150	2	13.33	1.39
Schenectady Police Department	Schenectady	NY	166	8	48.19	5.17
Scottsdale Police Dept	Maricopa	AZ	417	1	2.40	0.03
Scranton Police Department	Lackawanna	PA	155	4	25.81	1.87
Seattle Police Department	King	WA	1283	9	7.01	0.47
Shreveport Police Department	Caddo	LA	511	12	23.48	4.71
Sioux Falls Police Department	Minnehaha	SD	221	1	4.52	0.59
Somerville Police Department	Middlesex	MA	130	2	15.38	0.13
South Bend Police	St. Joseph	IN	255	8	31.37	3.00
Southampton Town Police Department	Suffolk	NY	102	1	9.80	0.07
Spokane Police Department	Spokane	WA	295	6	20.34	1.27
Springfield Police Department	Hampden	MA	464	9	19.40	1.94
Springfield Police Department	Clark	OH	127	1	7.87	0.72

Springfield Police Dept	Greene	MO	306	3	9.80	1.09
Springfield Police Dept	Sangamon	IL	273	1	3.66	0.51
St. Charles Police Dept	St. Charles	MO	112	1	8.93	0.28
St. Joseph Police Dept	Buchanan	MO	114	1	8.77	1.12
St. Louis (city) Police Dept	St. Louis City	MO	1351	10	7.40	3.13
St. Paul Police Department	Ramsey	MN	598	8	13.38	1.57
St. Petersburg Police Department	Pinellas	FL	510	6	11.76	0.65
Stamford Police Department	Fairfield	CT	292	3	10.27	0.33
Stockton Police Department	San Joaquin	CA	415	2	4.82	0.29
Stratford Police Department	Fairfield	CT	111	3	27.03	0.33
Suffolk Police Department	Suffolk	VA	171	1	5.85	1.18
Sugar Land Police Department	Fort Bend	TX	130	2	15.38	0.34
Sumter Police Department	Sumter	SC	107	3	28.04	2.79
Sunrise Police Department	Broward	FL	175	1	5.71	0.06
Surprise Police Department	Maricopa	AZ	127	1	7.87	0.03
Syracuse Police Department	Onondaga	NY	489	3	6.13	0.64
Tacoma Police Department	Pierce	WA	371	3	8.09	0.38
Tallahassee Police Department	Leon	FL	364	1	2.75	0.36
Tampa Police Department	Hillsborough	FL	980	3	3.06	0.24
Tempe Police Department	Maricopa	AZ	357	1	2.80	0.03
Texarkana Police Department	Bowie	TX	94	1	10.64	1.08
Texas City Police Department	Galveston	TX	85	2	23.53	0.69
Tinley Park Police Dept	Cook	IL	81	2	24.69	0.04
Titusville Police Department	Brevard	FL	88	1	11.36	0.18
Toledo Police Department	Lucas	OH	640	12	18.75	2.72
Topeka Police Department	Shawnee	KS	283	4	14.13	2.25
Trenton Police	Mercer	NJ	361	6	16.62	1.64
Troy Police Department	Rensselaer	NY	121	1	8.26	0.63
Tucson Police Department	Pima	AZ	1032	6	5.81	0.61
Tulsa Police Department	Tulsa	OK	826	11	13.32	1.82
Tupelo Police Department	Lee	MS	115	1	8.70	1.21
Tuscaloosa Police Department	Tuscaloosa	AL	263	1	3.80	0.51
Union City Police	Hudson	NJ	165	3	18.18	0.47
Utica Police Department	Oneida	NY	179	2	11.17	0.85
Vacaville Police Department	Solano	CA	111	1	9.01	0.24
Valdosta Police Department	Lowndes	GA	133	1	7.52	0.92

Victoria Police Department	Victoria	TX	106	2	18.87	2.30
Vineland Police	Cumberland	NJ	157	2	12.74	1.27
Virginia Beach Police Department	Virginia Beach City	VA	813	9	11.07	2.05
Visalia Department of Public Safety	Tulare	CA	136	1	7.35	0.23
Waco Police Department	McLennan	TX	246	8	32.52	3.41
Warren Police Department	Macomb	MI	230	1	4.35	0.12
Washington Metropolitan Police Dept	District of Columbia	DC	3742	29	7.75	4.82
Washington Township Police	Gloucester	NJ	86	1	11.63	0.35
Waterbury Police Department	New Haven	CT	256	4	15.63	0.46
Waterloo Police Department	Black Hawk	IA	120	4	33.33	3.05
Waukegan Police Dept	Lake	IL	155	2	12.90	0.28
Wayne Township Police	Passaic	NJ	117	1	8.55	0.20
West Bloomfield Township Police	Oakland	MI	81	1	12.35	0.08
West Chester Police Department	Butler	OH	90	1	11.11	0.27
West Haven Police Department	New Haven	CT	122	2	16.39	0.23
West Jordan Police Department	Salt Lake	UT	102	2	19.61	0.19
West New York Police	Hudson	NJ	119	1	8.40	0.16
West Palm Beach Police Department	Palm Beach	FL	310	3	9.68	0.23
West Valley City Police Department	Salt Lake	UT	186	1	5.38	0.10
Westminster Police Department	Orange	CA	100	2	20.00	0.07
Westminster Police Dept	Adams	CO	178	4	22.47	0.91
Weymouth Police Department	Norfolk	MA	96	1	10.42	0.15
Wheeling Police Department	Ohio	WV	84	2	23.81	4.50
White Plains Police Department	Westchester	NY	210	1	4.76	0.11
Wichita Falls Police Department	Wichita	TX	177	2	11.30	1.52
Wichita Police Department	Sedgwick	KS	662	2	3.02	0.40
Wilkes Barre City Police Department	Luzerne	PA	92	1	10.87	0.31
Wilmington Police Department	New Hanover	NC	266	2	7.52	0.99
Wilmington Police Department	New Castle	DE	306	2	6.54	0.37
Wilson Police Department	Wilson	NC	114	2	17.54	2.46
Winston-Salem Police Department	Forsyth	NC	508	3	5.91	0.86
Woodbridge Police	Middlesex	NJ	206	1	4.85	0.12
Woonsocket Police Department	Providence	RI	99	4	40.40	0.64
Worcester Police Department	Worcester	MA	482	5	10.37	0.63
Yakima Police Department	Yakima	WA	134	1	7.46	0.41
Yonkers Police Department	Westchester	NY	641	2	3.12	0.21

York Police Department	York	PA	110	1	9.09	0.23
Yuma Police Department	Yuma	AZ	167	2	11.98	1.02

Table 84. Special State & Local Law Enforcement Agencies in Study: Rates of Officers Arrested, 2005-2011 (Sorted Alphabetically)

Agency	County	State	# of Full-Time Sworn Personnel	Per Agency	Per 1,000 Officers	Per 100,000 Population
Allegheny Port Authority Transit Police	Allegheny	PA	42	1	23.81	0.08
Anchorage International Airport Police	Anchorage	AK	65	1	15.38	0.34
Appalachian State University Police Dept	Watauga	NC	25	1	40.00	1.96
Arkansas State University Police Dept.	Craighead	AR	17	1	58.82	1.04
Austin I.S.D. Police Department	Travis	TX	70	1	14.29	0.10
Baltimore City School Police Dept.	Baltimore City	MD	142	1	7.04	0.16
BART Police Department	Alameda	CA	192	1	5.21	0.07
Beaumont I.S.D. Police Dept.	Jefferson	TX	22	1	45.45	0.40
Boston School Police	Suffolk	MA	80	1	12.50	0.14
Bowie State University Dept. of Public Safety	Prince Georges	MD	14	1	71.43	0.12
Buffalo State College Police	Erie	NY	30	1	33.33	0.11
BYU-Idaho Police Department	Madison	ID	10	1	100.00	2.66
California Bureau of Narcotics Enforcement	Sacramento	CA	73	2	27.40	0.02
California Dept. of Justice	Sacramento	CA	419	1	2.39	0.10
California Exposition And State Fair Police	Sacramento	CA	6	1	166.67	0.07
Cameron Co. District Attorney Investigations Div	Cameron	TX	30	1	33.33	0.25
Central Michigan University Police Department	Isabella	MI	21	1	47.62	1.42
College of Lake County Police Dept	Lake	IL	13	1	76.92	0.14
Connally I.S.D. Police Dept.	McLennan	TX	3	1	333.33	0.43
Dallas I.S.D. Police Dept.	Dallas	TX	88	1	11.36	0.04
Dayton International Airport Police Dept	Montgomery	OH	29	1	34.48	0.19
Delaware River & Bay Authority Police	New Castle	DE	50	1	20.00	0.51
Delaware River Port Authority - Transit Police	Camden	NJ	144	1	6.94	0.19
District of Columbia Protective Services Police	District of Columbia	DC	484	1	2.07	0.17
Duke University Police Department	Durham	NC	60	1	16.67	0.37
Ennis I.S.D. Police Department	Ellis	TX	5	1	200.00	0.67
Florida Atlantic University Police	Palm Beach	FL	39	1	25.64	0.08
Florida Fish & Wildlife Conservation Commission	Leon	FL	626	4	6.39	0.44
Florida International University Police	Miami-Dade	FL	39	1	25.64	0.04
George Mason University Police Dept.	Fairfax	VA	52	1	19.23	0.09
Georgia Public Safety Training Center	Monroe	GA	19	1	52.63	3.78

Georgia State University Police	Fulton	GA	68	1	14.71	0.11
Grambling State University Police Dept.	Lincoln	LA	9	2	222.22	4.28
Greenville Technical College Public Safety	Greenville	SC	9	1	111.11	0.22
Houston Baptist University Police Department	Harris	TX	30	1	33.33	0.02
Houston Community College System	Harris	TX	48	1	20.83	0.02
Humble I.S.D. Police Dept.	Harris	TX	24	1	41.67	0.02
Indiana State Excise Police	Marion	IN	88	1	11.36	0.11
Indiana University Purdue U. Fort Wayne U. Police	Allen	IN	18	1	55.56	0.28
Kansas State Law Enforcement Training Center	Reno	KS	39	1	25.64	0.20
Kentucky Alcoholic Beverage Control	Franklin	KY	30	2	66.67	0.27
Lafayette College Office of Public Safety	Northampton	PA	18	1	55.56	0.34
Lancaster I.S.D. Police Dept.	Dallas	TX	6	1	166.67	0.04
Lander University Public Safety	Greenwood	SC	10	1	100.00	1.44
Lehigh-Northampton Airport Auth. Police Dept	Lehigh	PA	9	1	111.11	0.29
Los Angeles School Police Department	Los Angeles	CA	340	2	5.88	0.02
Louisiana State Univ. Health Sciences Center Police Dept	Caddo	LA	49	1	20.41	0.39
Louisiana State University Police Department	East Baton Rouge	LA	62	1	16.13	0.23
Maryland Department of General Services Police	Baltimore City	MD	68	1	14.71	0.16
Maryland National Capital Park Police - Montgomery Co	Montgomery	MD	86	1	11.63	0.41
Maryland Natural Resources Police	Anne Arundel	MD	224	1	4.46	0.19
Maryland Transit Administration Police	Baltimore City	MD	140	1	7.14	0.16
Maryland Transportation Authority Police	Baltimore	MD	456	1	2.19	0.16
Massachusetts Dept of Mental Health Police Dept	Suffolk	MA	40	2	50.00	0.28
MBTA Transit Police	Suffolk	MA	256	2	7.81	0.28
McAllen I.S.D. Police Dept.	Hidalgo	TX	43	1	23.26	0.13
Medical College of Georgia	Richmond	GA	32	1	31.25	0.50
Medical University of South Carolina Public Safety	Charleston	SC	62	1	16.13	0.29
Metropolitan Washington Airports Authority Police	Arlington	VA	206	1	4.85	0.09
Middlesex County Prosecutor's Office	Middlesex	NJ	80	1	12.50	0.12
Midland I.S.D. Police Dept.	Midland	TX	11	1	90.91	0.73
Mississippi Department of Wildlife, Fisheries & Parks	Hinds	MS	230	1	4.35	1.05
Missouri Department of Corrections	Cole	MO	13	1	76.92	1.32
Missouri Univ. of Science & Technology Police Dept	Phelps	MO	11	1	90.91	2.21
MIT Police Department	Middlesex	MA	59	1	16.95	0.07
Morrisville State College Police	Madison	NY	11	1	90.91	1.36
New Jersey Department of Environmental Protection	Burlington	NJ	90	1	11.11	0.11

New Jersey Transit Police	Essex	NJ	201	3	14.93	0.47
New Mexico Department Of Game & Fish	Santa Fe	NM	106	1	9.43	0.69
New York City Dept of Environmental Protection Police	Westchester	NY	168	1	5.95	1.29
New York State Metro Transportation Auth. Police	New York	NY	694	2	2.88	0.13
New York State Park Police	Albany	NY	305	1	3.28	0.21
North Forest I.S.D. Police Dept.	Harris	TX	21	1	47.62	0.02
Northern Illinois University Police	DeKalb	IL	59	1	16.95	0.95
Northside I.S.D. Police Dept.	Bexar	TX	83	2	24.10	0.12
Ohio Dept of Natural Resources - Ofc. of Law Enf.	Franklin	OH	394	2	5.08	3.24
Ohio Department of Taxation - Enforcement Division	Franklin	OH	30	1	33.33	0.18
Ohio State University Police Department	Franklin	OH	51	1	19.61	0.09
Palm Beach County School District Police	Palm Beach	FL	176	4	22.73	0.30
Pennsylvania Dept of Conservation & Natural Resources	Dauphin	PA	136	1	7.35	0.79
Port Authority of New York & New Jersey Police Dept	Hudson	NJ	1667	1	0.60	0.16
San Antonio Park Rangers	Bexar	TX	112	3	26.79	0.17
Santa Ana Unified School District Police Dept.	Orange	CA	21	2	95.24	0.07
Santa Rosa I.S.D. Police Department	Cameron	TX	3	1	333.33	0.25
School District of Philadelphia Police	Philadelphia	PA	450	1	2.22	0.07
Shippensburg University of Pennsylvania Police	Cumberland	PA	17	1	58.82	0.42
Socorro I.S.D. Police Dept.	El Paso	TX	30	1	33.33	0.12
South Carolina Dept of Mental Health-Public Safety	Richland	SC	120	1	8.33	0.26
South Carolina Department of Natural Resources	Richland	SC	238	1	4.20	0.26
Southern University and A & M College Police	East Baton Rouge	LA	43	1	23.26	0.23
St. Edward's University Police Department	Travis	TX	14	1	71.43	0.10
St. Joseph County Airport Police	St. Joseph	IN	17	1	58.82	0.37
St. Mary's University Police Department	Bexar	TX	20	1	50.00	0.06
State University at Albany Police	Albany	NY	41	1	24.39	0.33
Tennessee State University	Davidson	TN	27	2	74.07	0.32
Texas Alcoholic Beverage Commission	Travis	TX	277	1	3.61	0.10
Tuskegee University Police Department	Macon	AL	33	1	30.30	4.66
United I.S.D. Police Dept.	Webb	TX	51	1	19.61	0.40
University of Alabama - Birmingham Police Dept	Jefferson	AL	79	1	12.66	0.15
University of Arkansas Medical Sciences Dept of Pub	Pulaski	AR	36	1	27.78	0.26
University of California - Los Angeles Police	Los Angeles	CA	57	1	17.54	0.01
University of Colorado - Colorado Springs Police Dept.	El Paso	CO	14	1	71.43	0.16
University of Florida Police	Alachua	FL	85	1	11.76	0.40

University of Illinois Police Dept	Champaign	IL	54	1	18.52	0.50
University of Maryland Eastern Shore Public Safety	Somerset	MD	6	1	166.67	3.78
University of North Texas Police Department	Denton	TX	40	1	25.00	0.15
University of Pittsburgh - Main Campus Police	Allegheny	PA	73	1	13.70	0.08
University of Pittsburgh at Johnstown Police	Cambria	PA	13	1	76.92	0.70
University of South Carolina - Upstate Police Dept	Spartanburg	SC	12	1	83.33	0.35
University of Tennessee at Knoxville Police	Knox	TN	52	2	38.46	10.47
University of Texas - Austin Police	Travis	TX	62	1	16.13	0.10
University of West Alabama Police	Sumter	AL	6	1	166.67	7.27
Vanderbilt University Police Department	Davidson	TN	91	1	10.99	0.16
Ventura College	Ventura	CA	5	1	200.00	0.12
Virginia Commonwealth University Police Dept.	Richmond City	VA	74	2	27.03	0.98
Virginia Marine Resources Commission	Newport News City	VA	60	1	16.67	3.02
Volusia County Beach Patrol	Volusia	FL	60	2	33.33	0.40
Washington Metropolitan Area Transit Auth. Police	District of Columbia	DC	442	2	4.52	0.33
Wayne State University Dept of Public Safety	Wayne	MI	49	1	20.41	0.05
Wisconsin Dept of Justice - Criminal Investigation Div.	Dane	WI	92	1	10.87	0.20

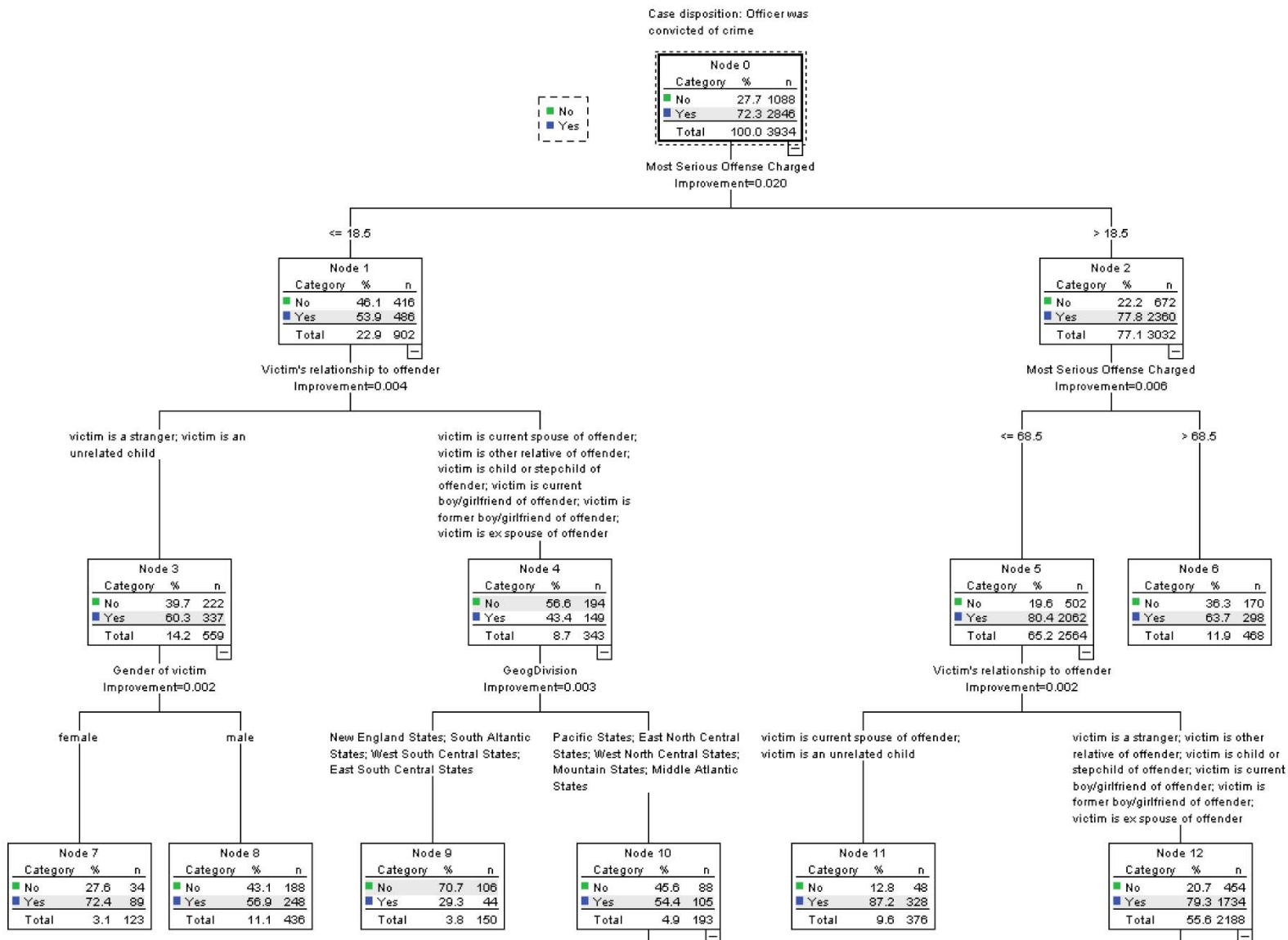

Figure 1. Police Crime Arrest Cases: CART Model Predicting Conviction

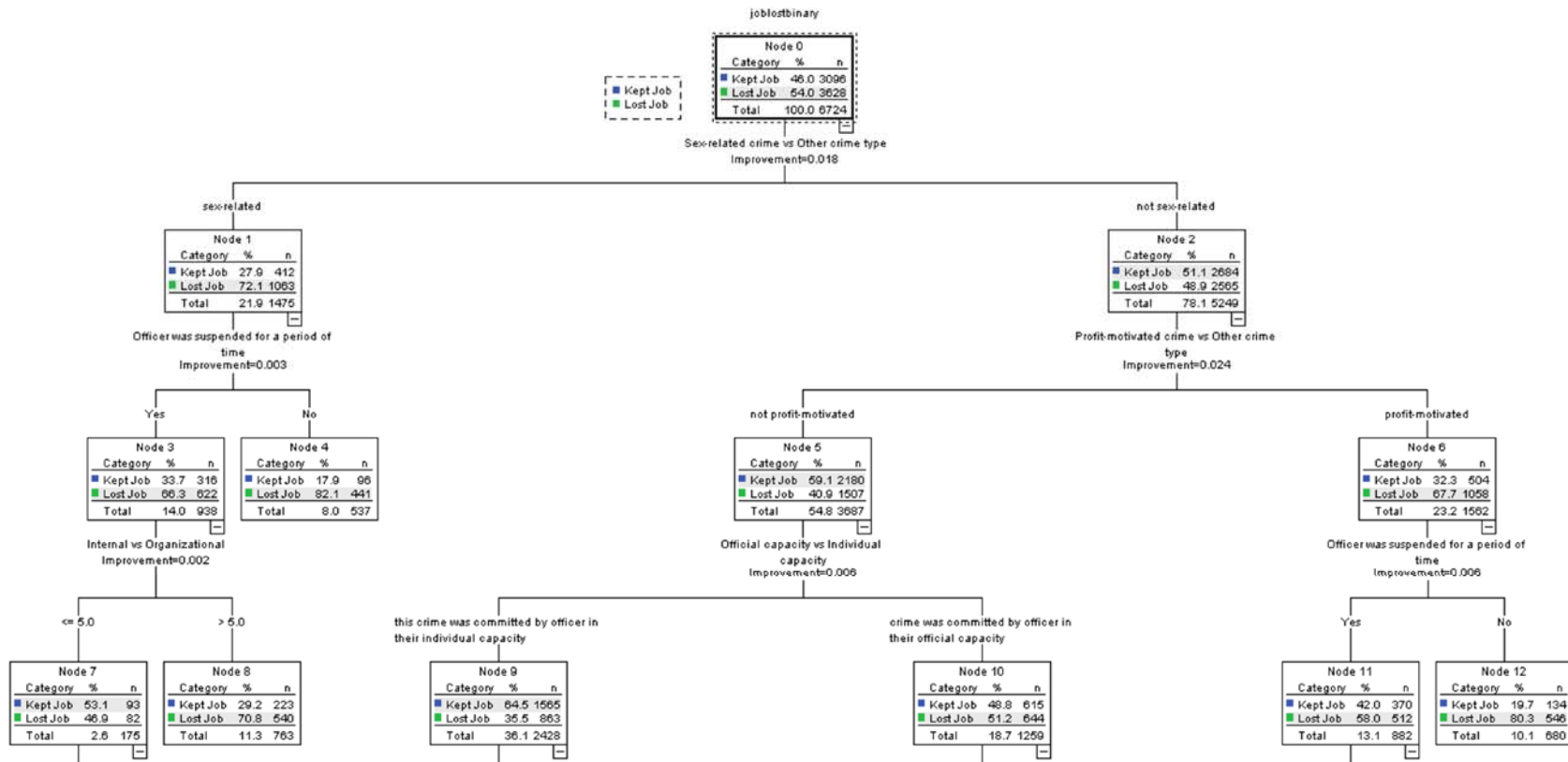
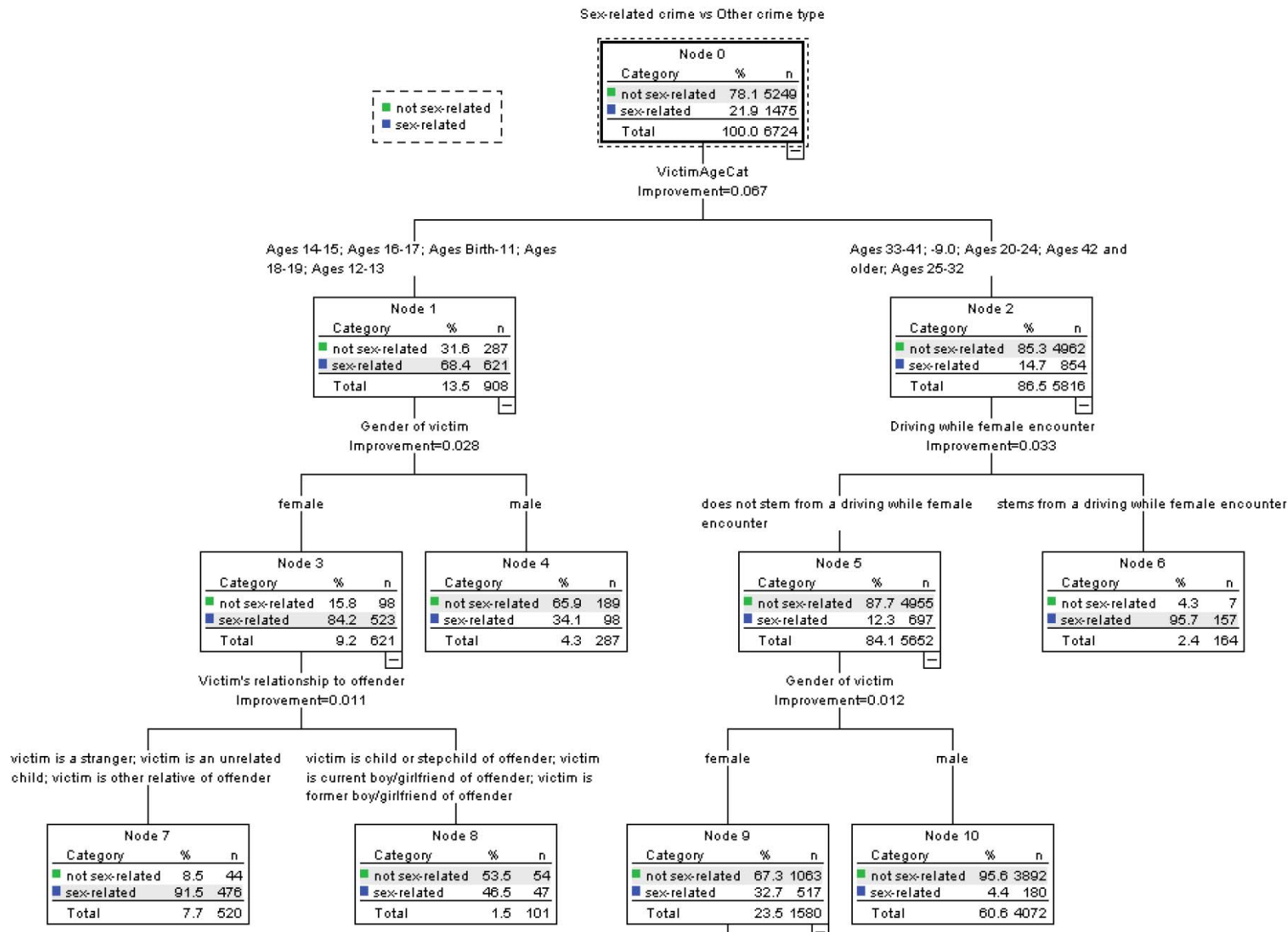

Figure 2. Police Crime Arrest Cases: CART Model Predicting Job Loss



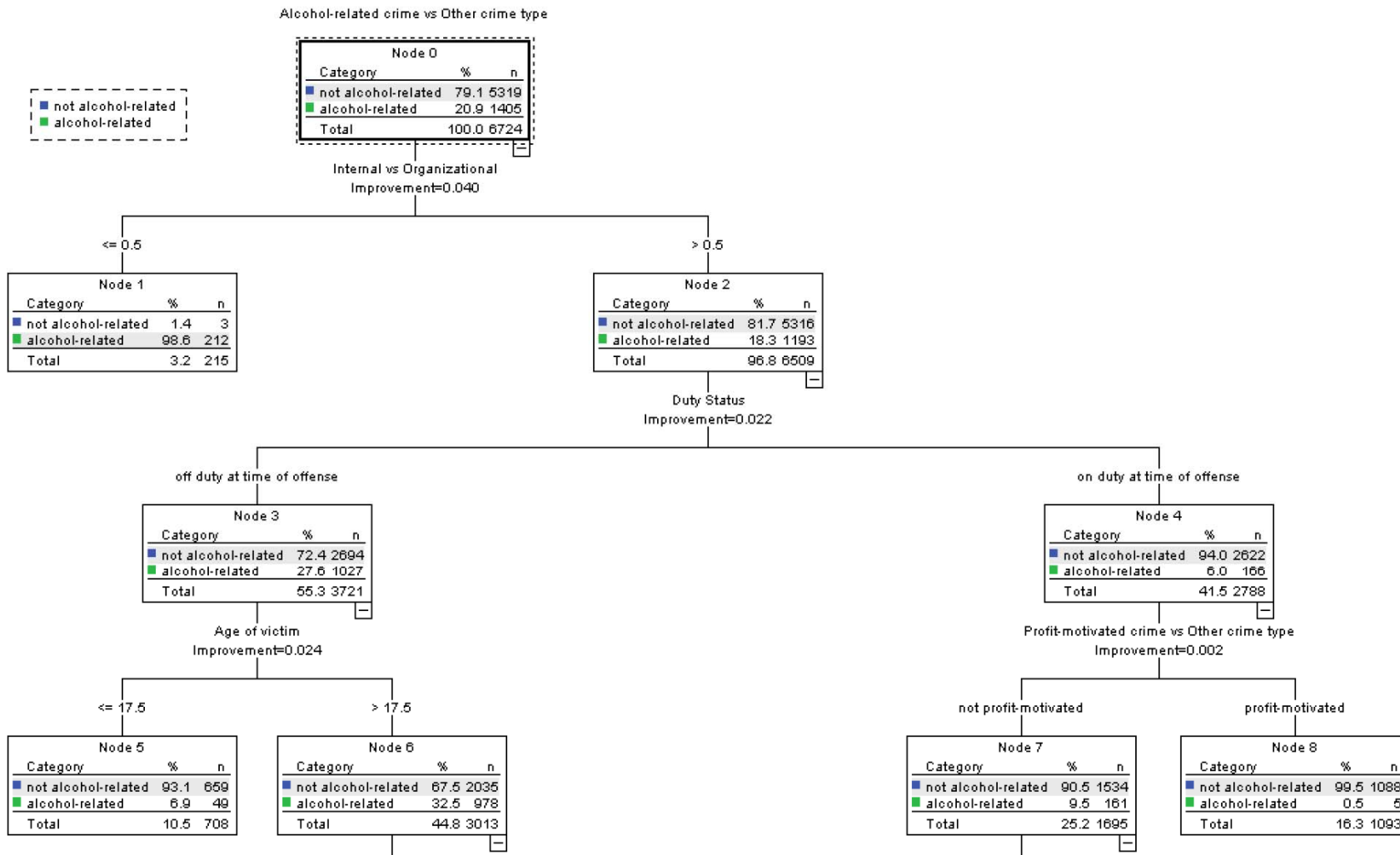

Figure 4. Police Crime: CART Model Predicting Alcohol-related Arrest Cases

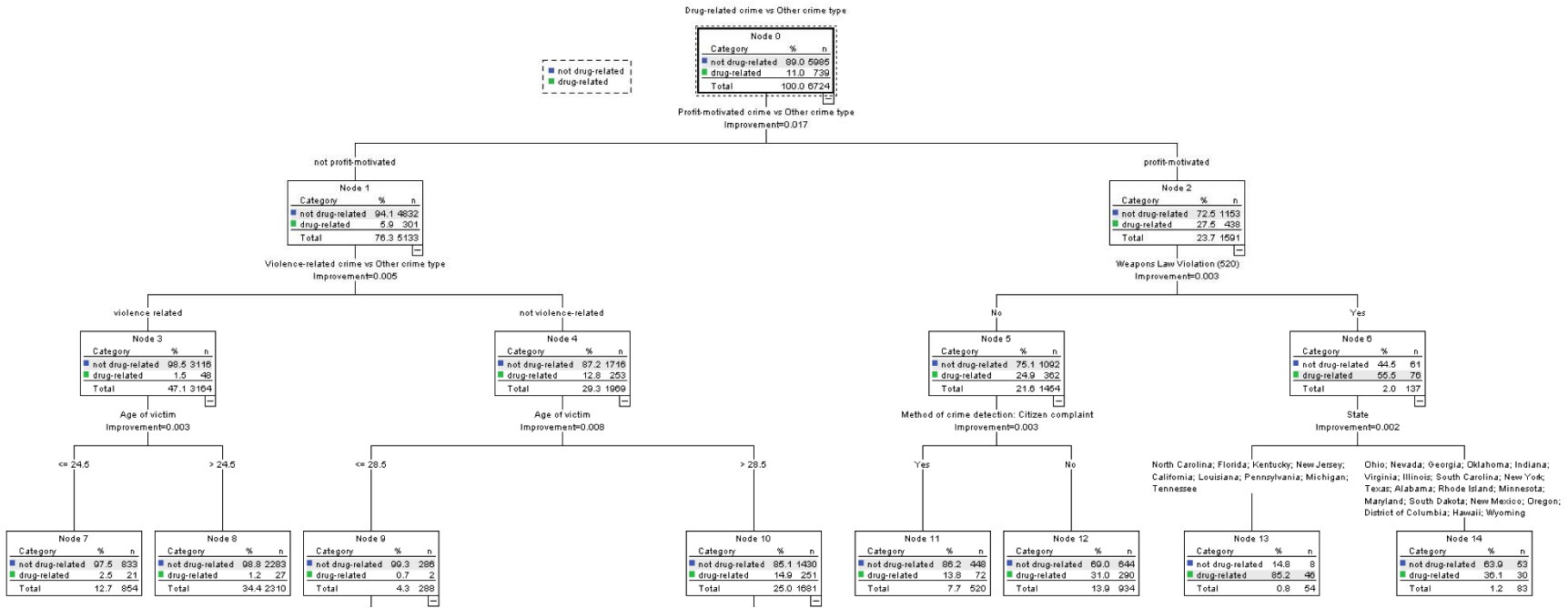

Figure 5. Police Crime: CART Model Predicting Drug-related Arrest Cases

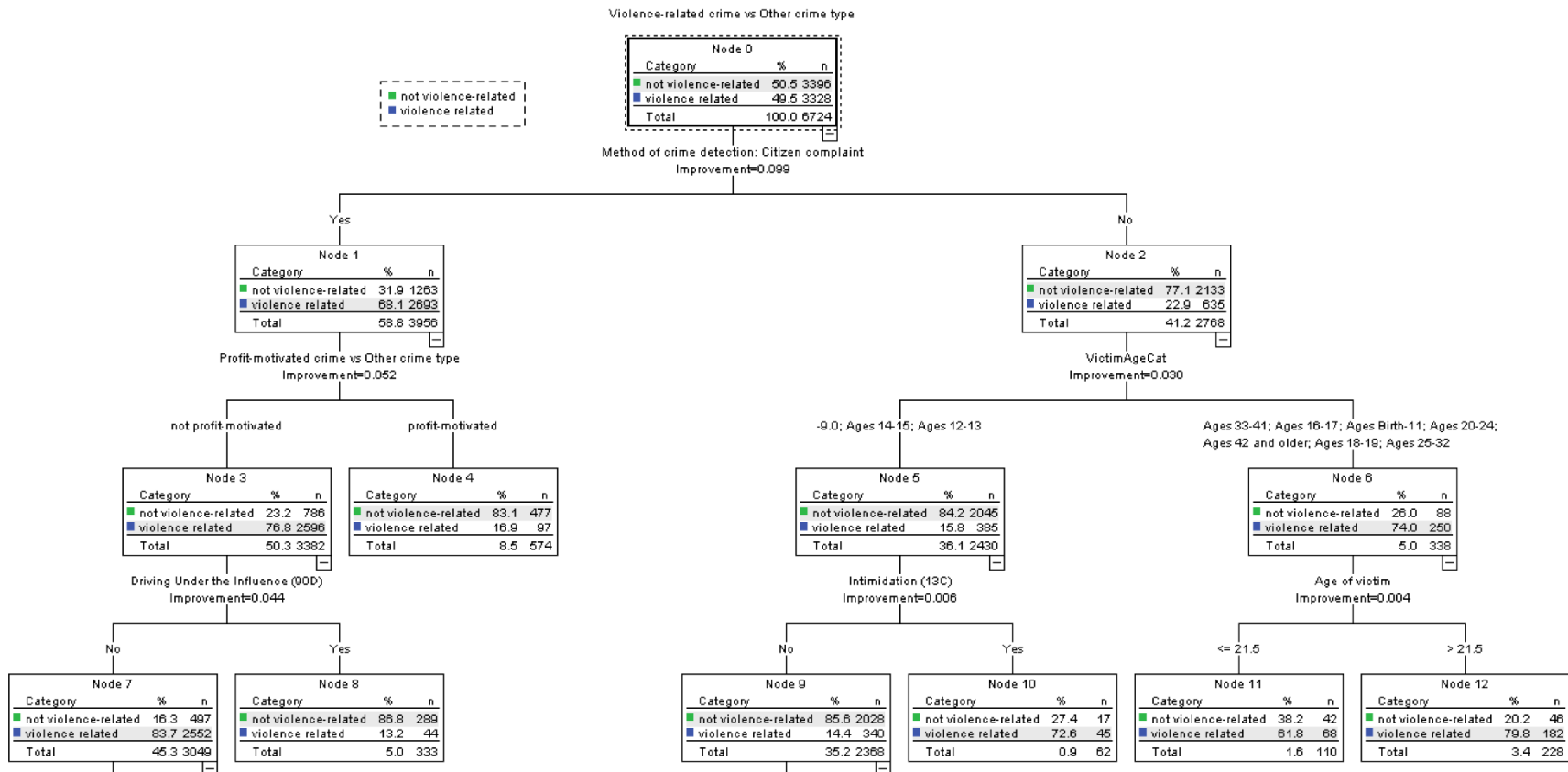

Figure 6. Police Crime: CART Model Predicting Violence-related Arrest Cases

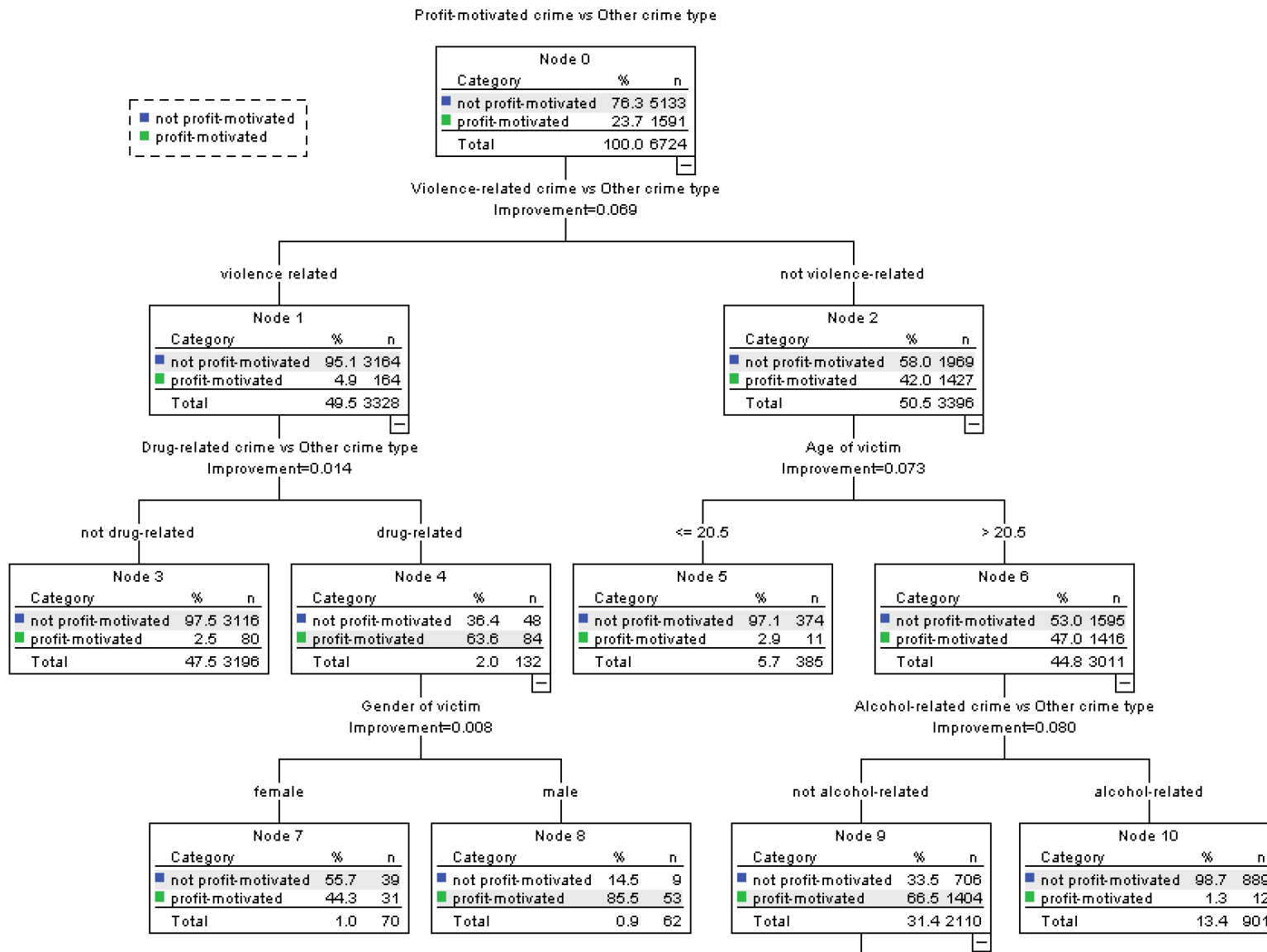

Figure 7. Police Crime: CART Model Predicting Profit-motivated Arrest Cases

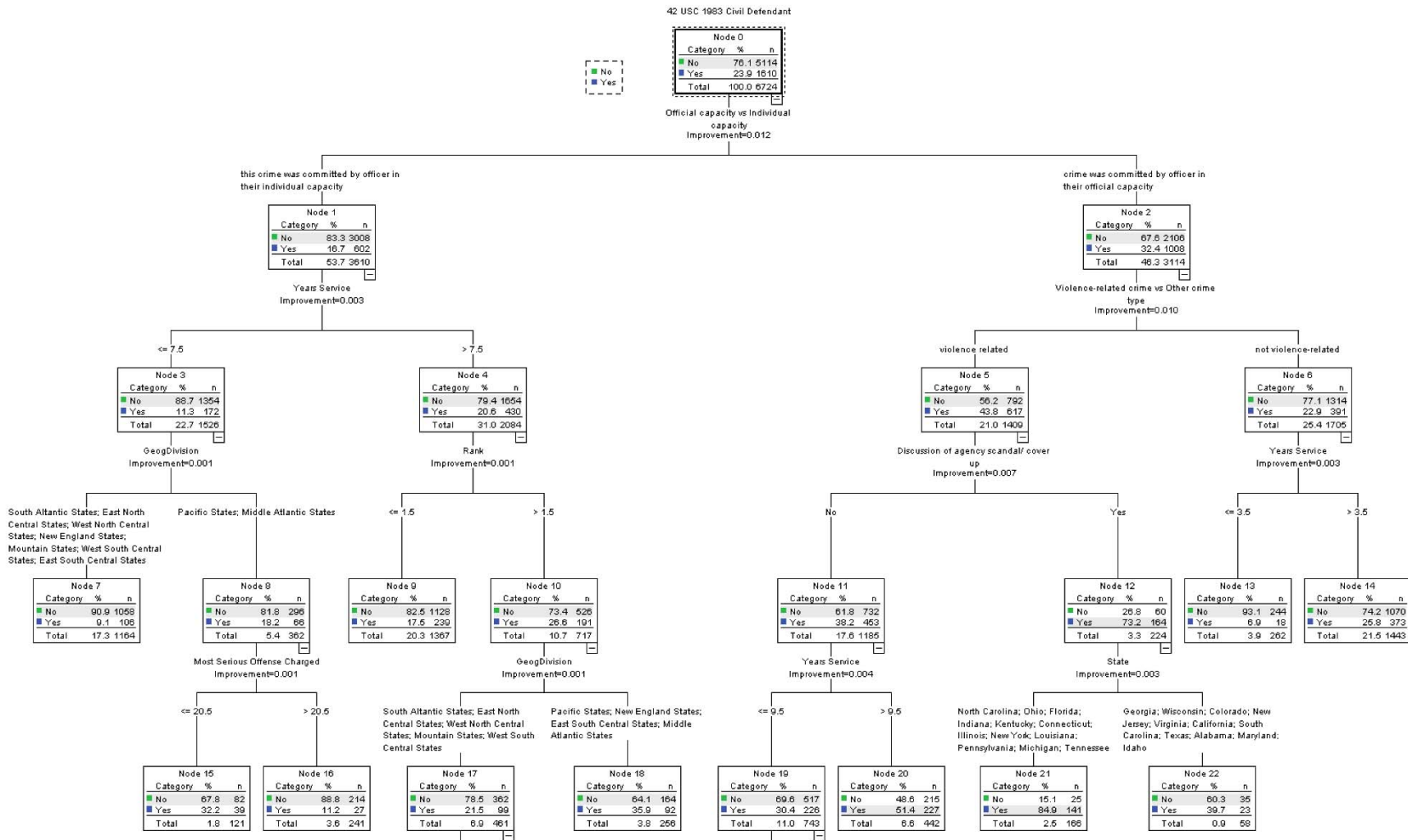

Figure 8. CART Model Predicting Being Named as a Party Defendant in a Section 1983 Civil Action at Some Point during Career

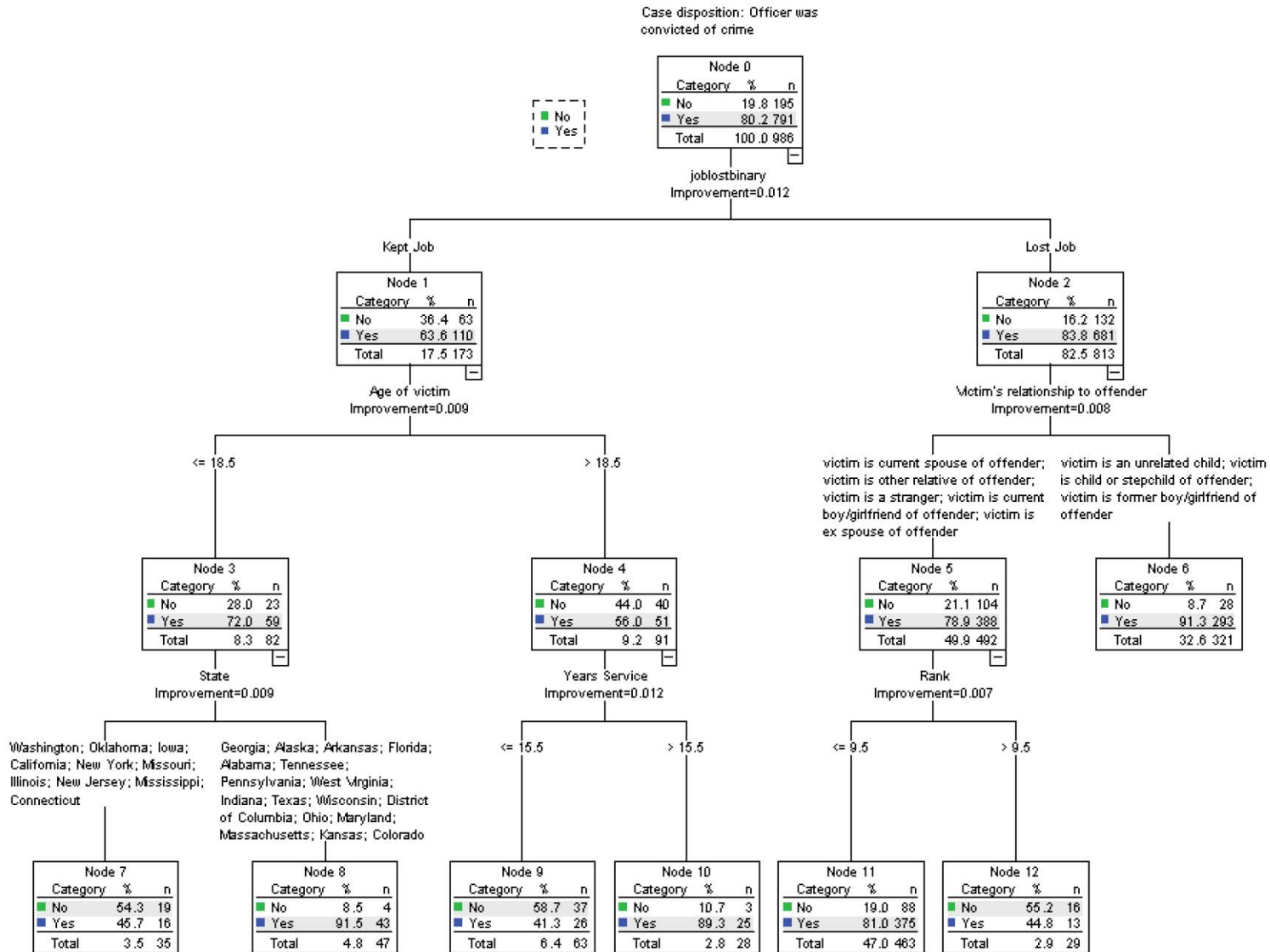

Figure 9. Sex-related Arrest Cases: CART Model Predicting Conviction

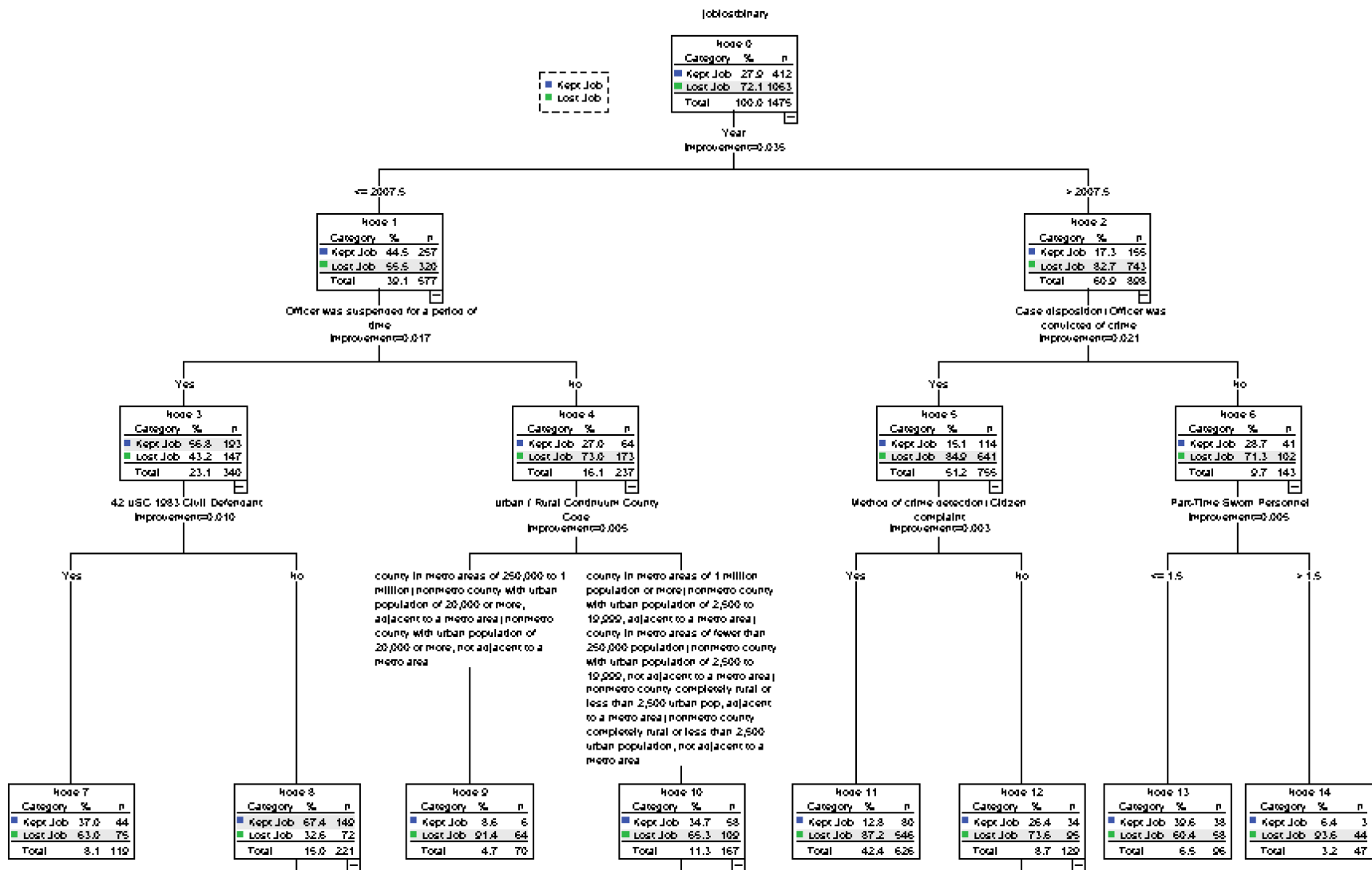

Figure 10. Sex-related Arrest Cases: CART Model Predicting Job Loss

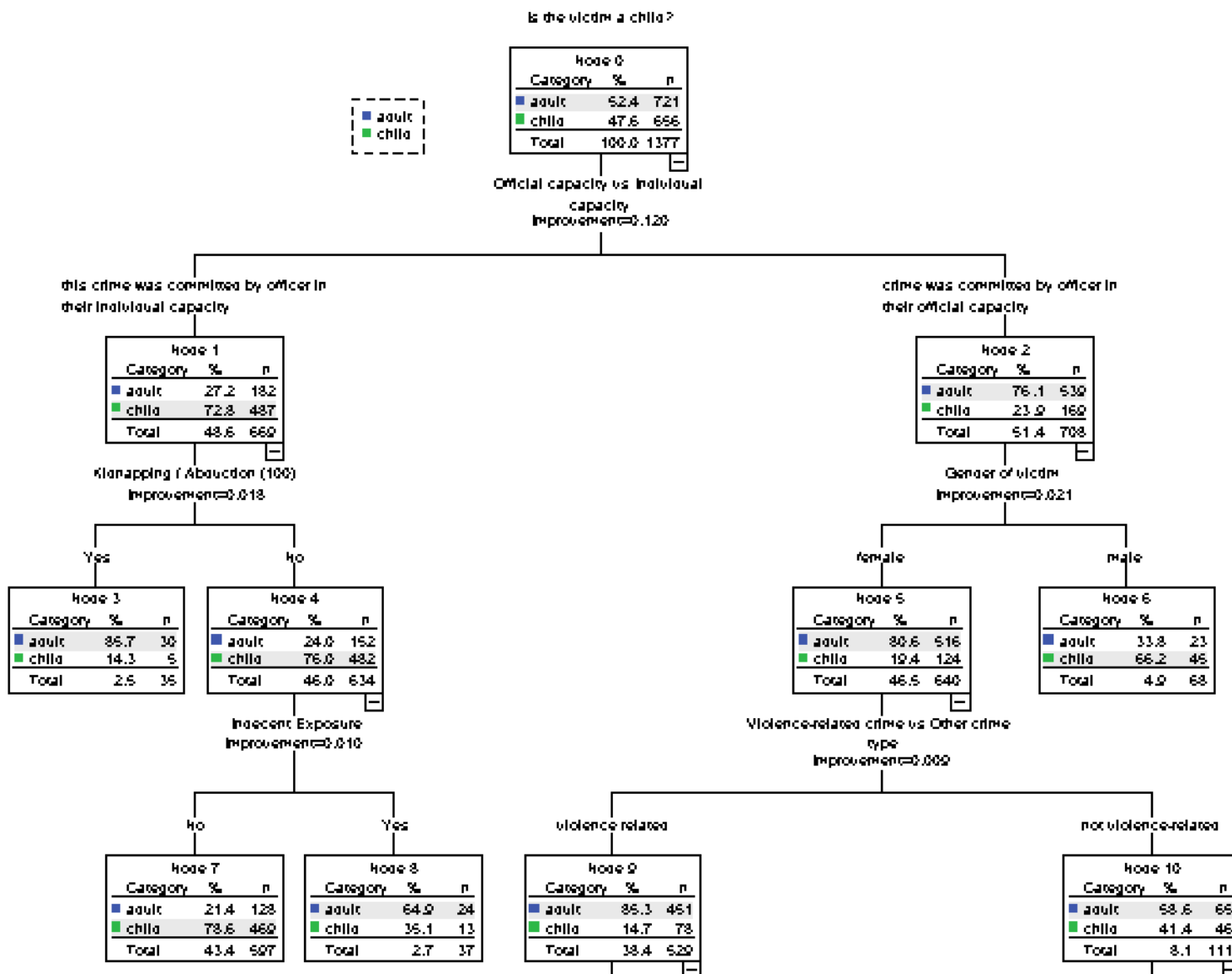

Figure 11. Sex-related Arrest Cases: CART Model Predicting Child Victims

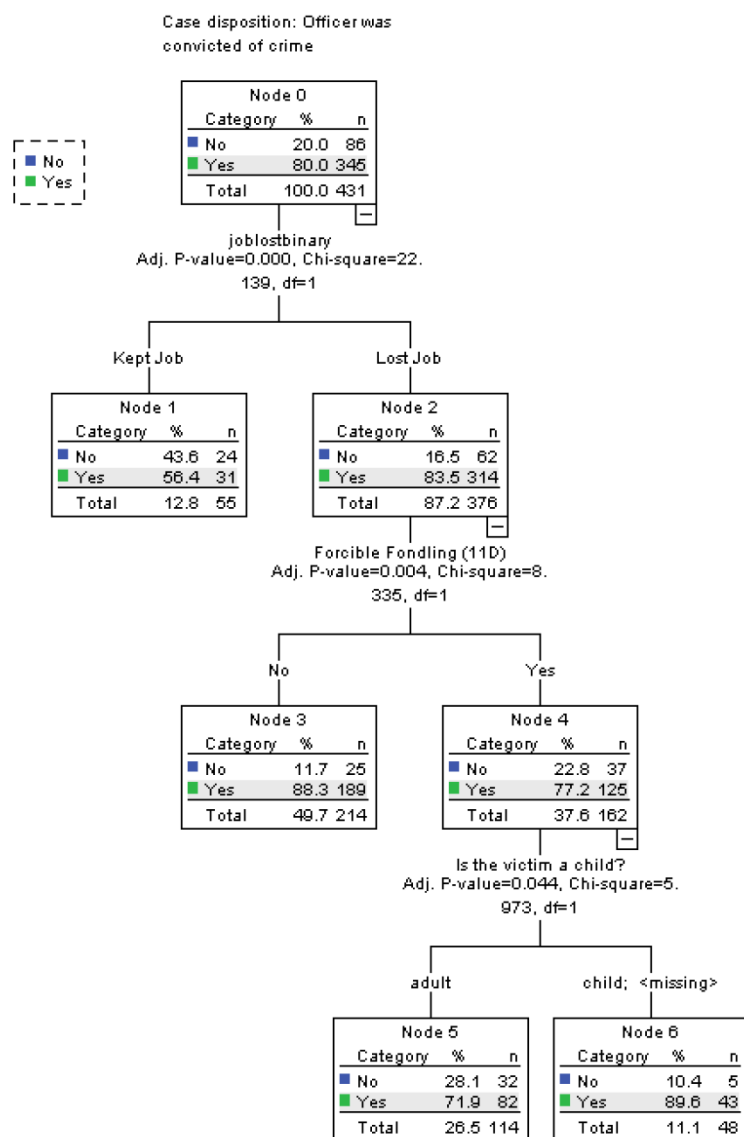

Figure 12. Police Sexual Violence Arrest Cases: CHAID Model Predicting Conviction

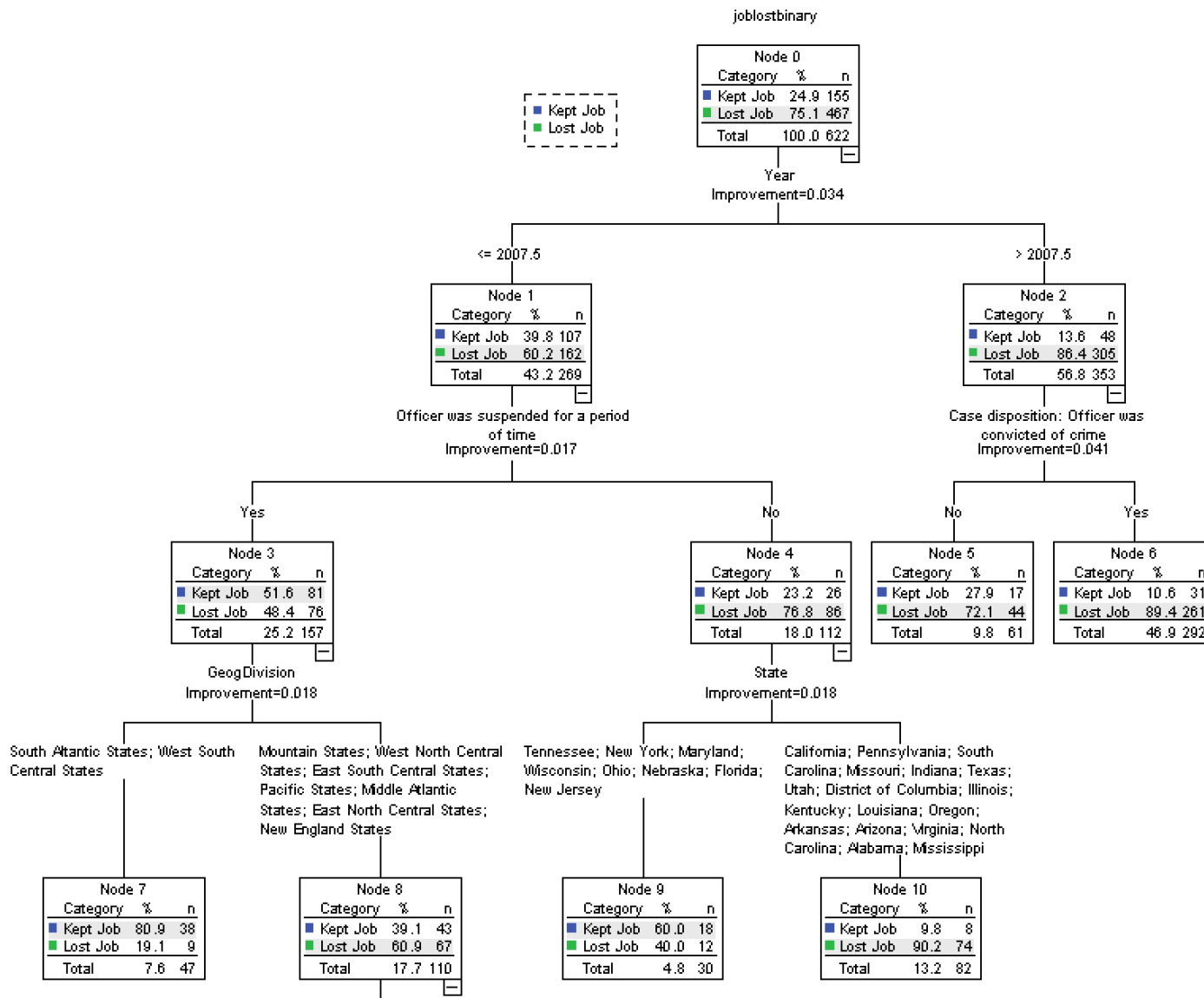

Figure 13. Police Sexual Violence Arrest Cases: CART Model Predicting Job Loss

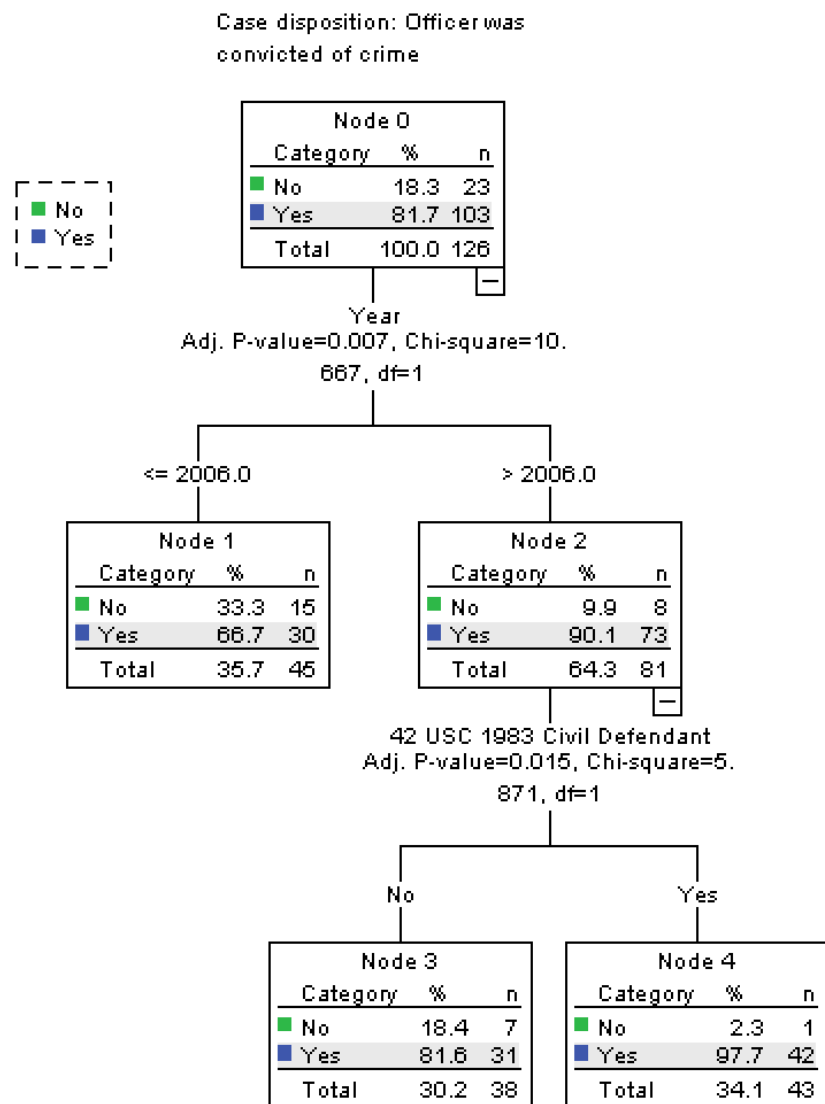

Figure 14. Driving While Female Encounters Arrest Cases: CHAID Model Predicting Conviction

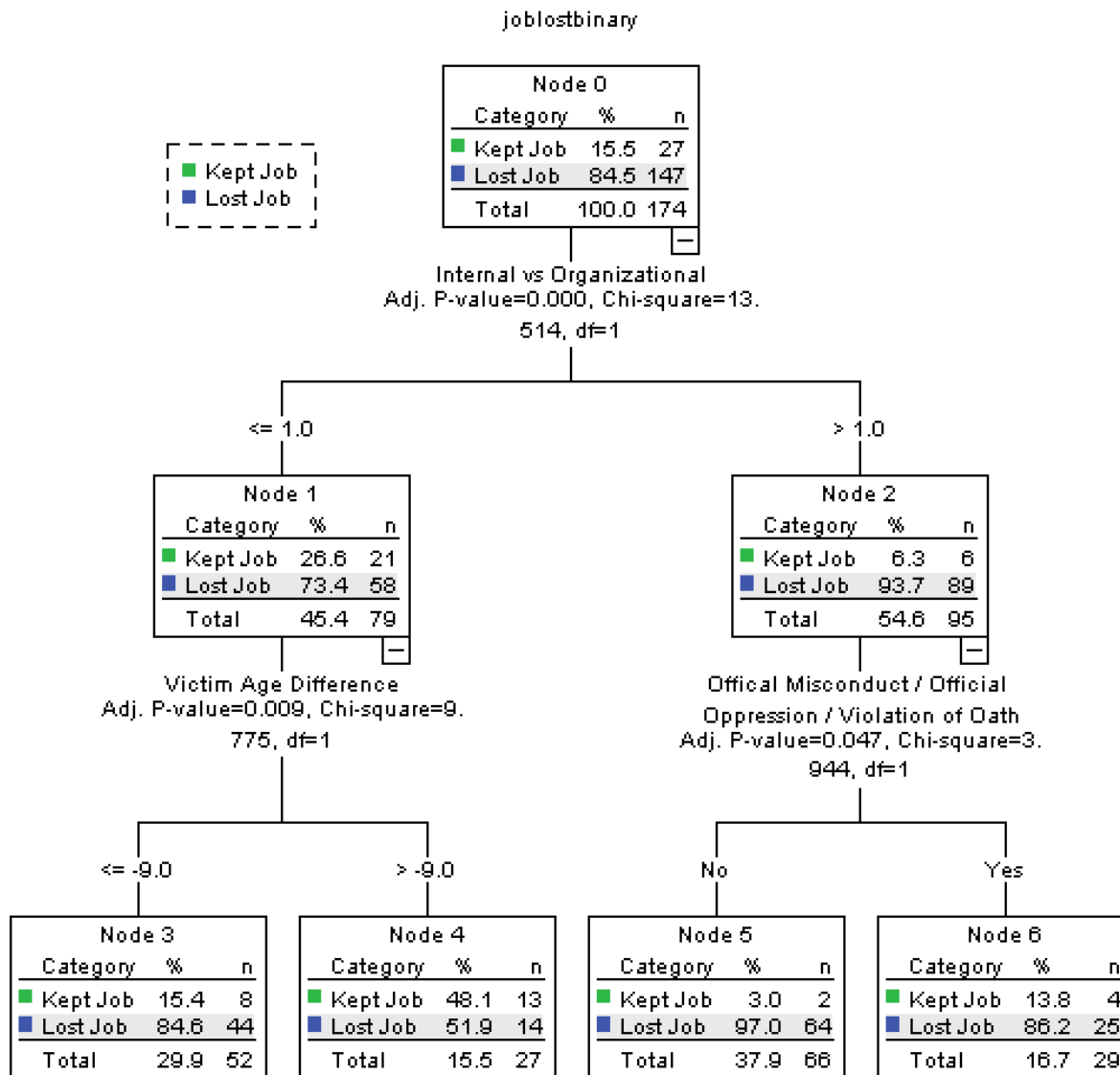

Figure 15. Driving While Female Encounters Arrest Cases: CHAID Model Predicting Job Loss

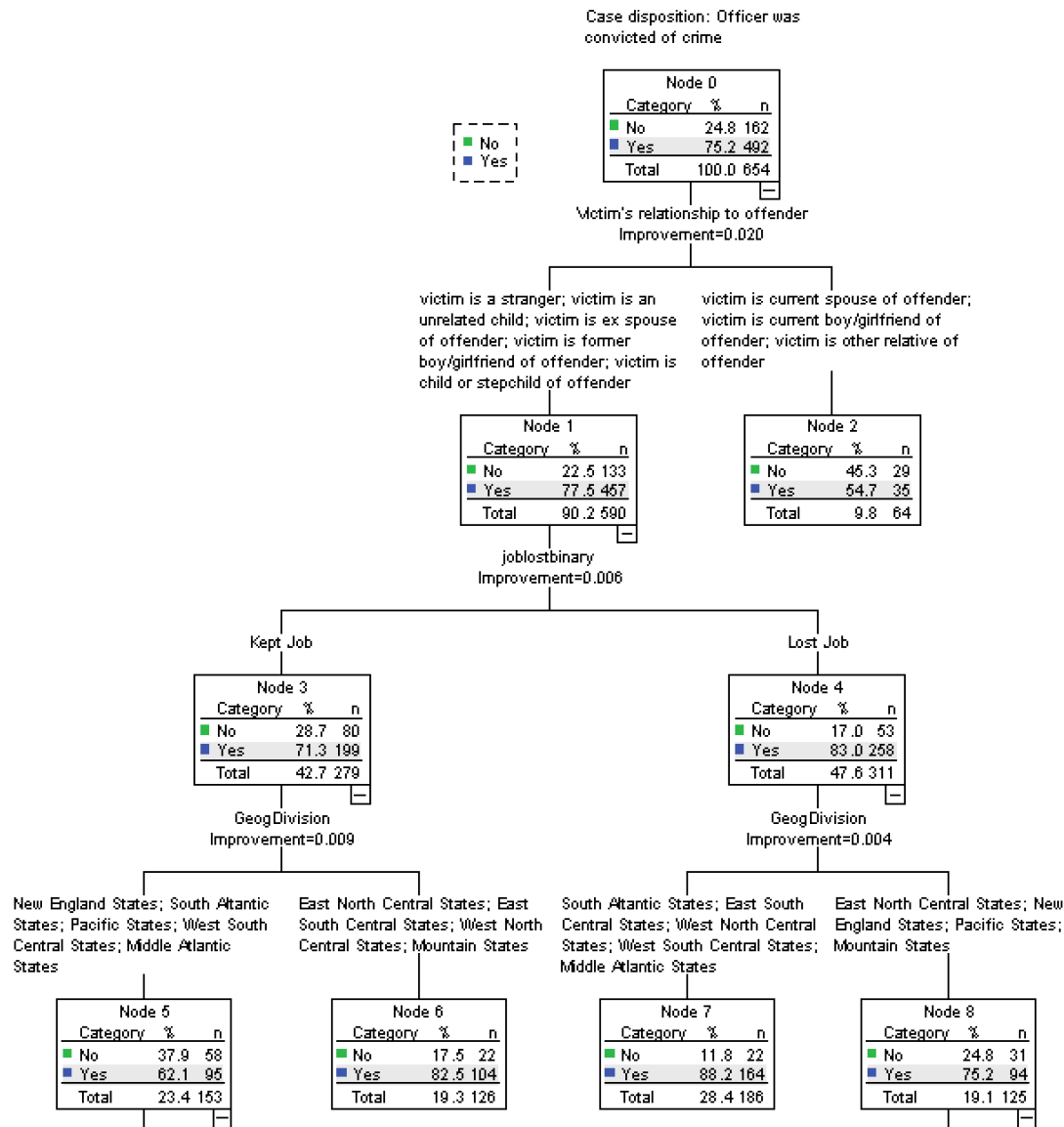

Figure 16. Alcohol-related Arrest Cases: CART Model Predicting Conviction

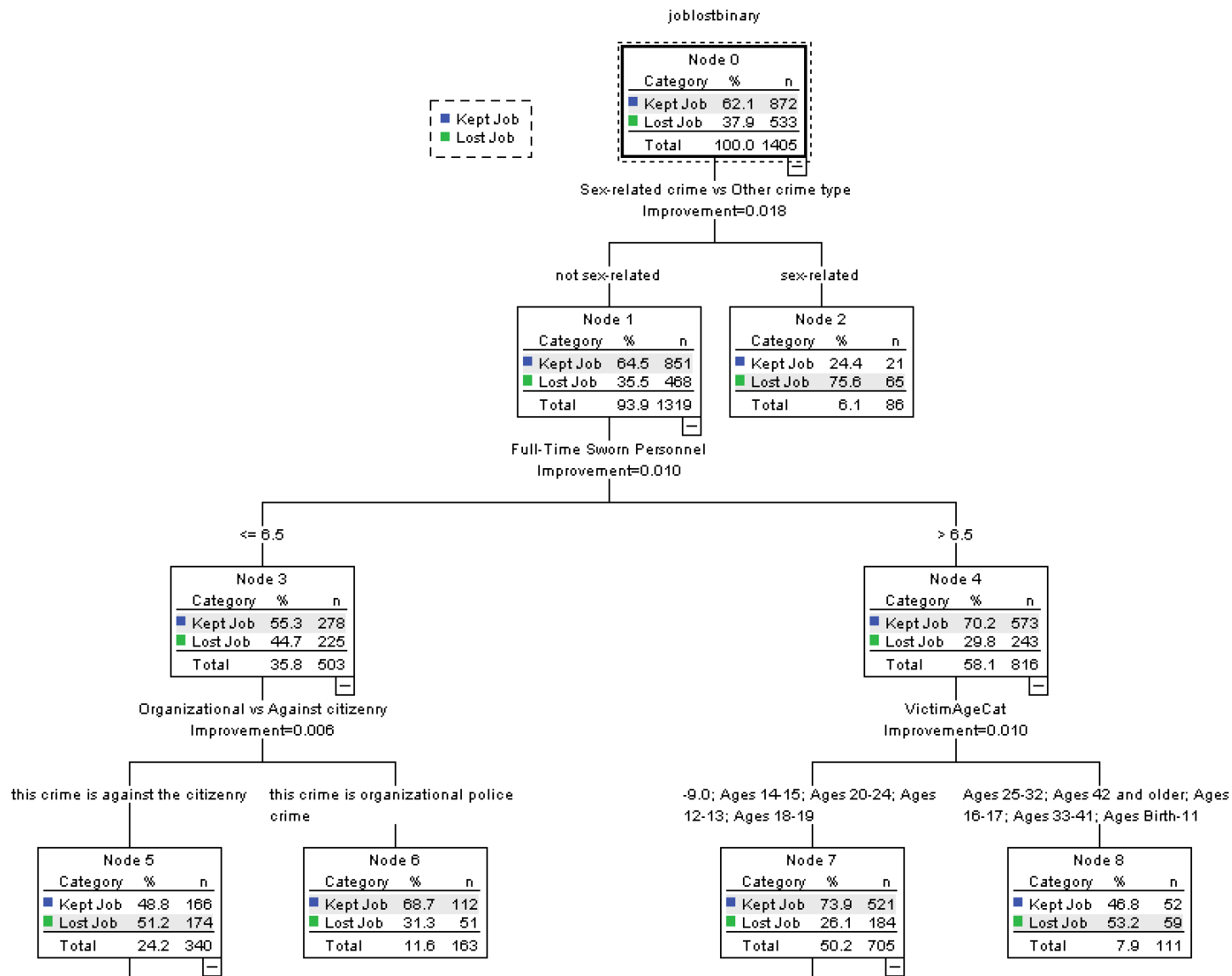

Figure 17. Alcohol-related Arrest Cases: CART Model Predicting Job Loss

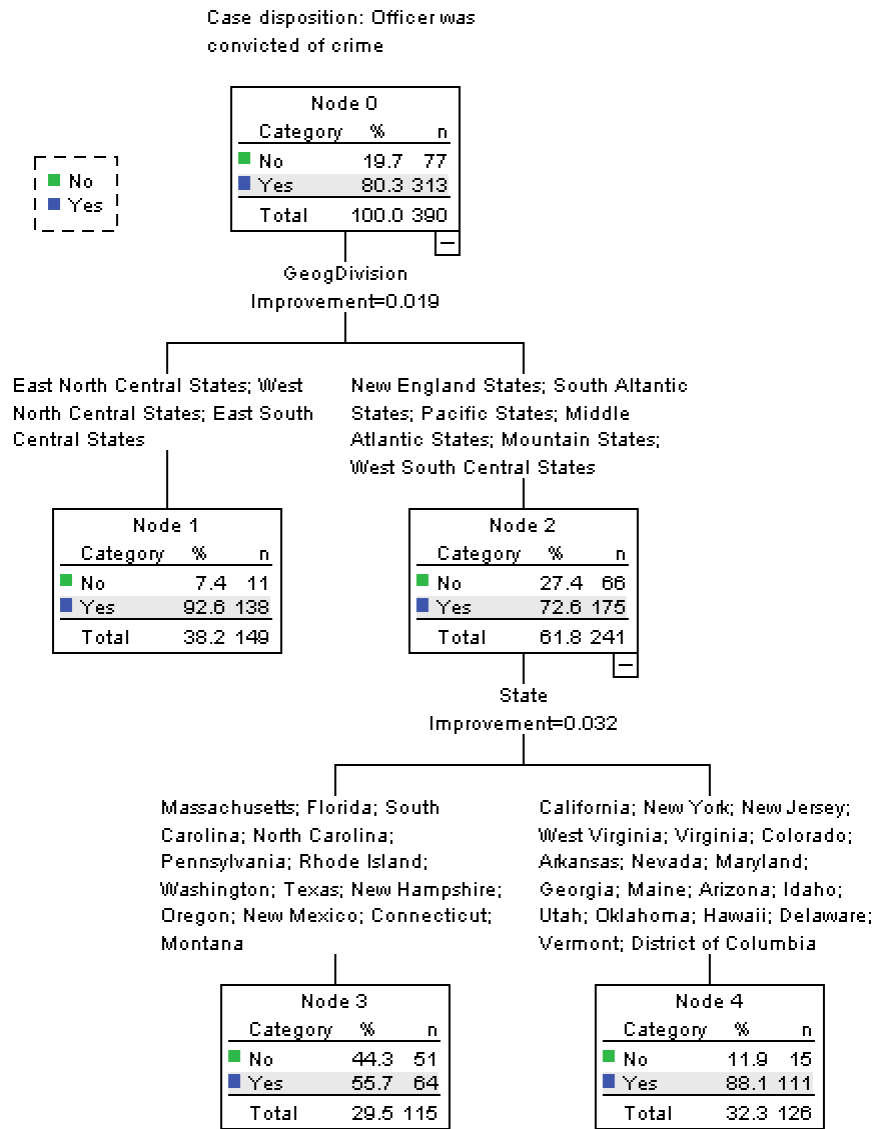

Figure 18. DUI Arrest Cases: CART Model Predicting Conviction

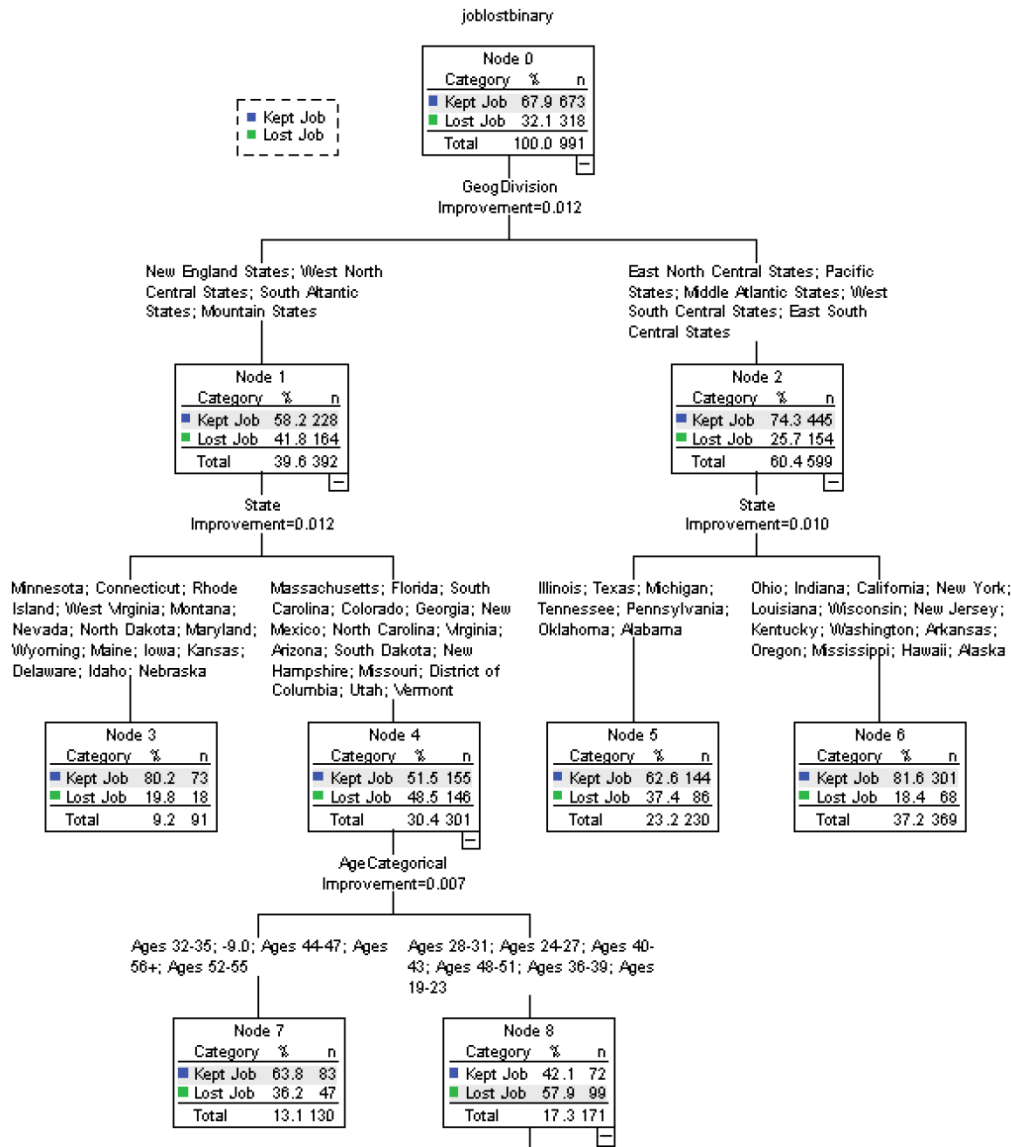

Figure 19. DUI Arrest Cases: CART Model Predicting Job Loss

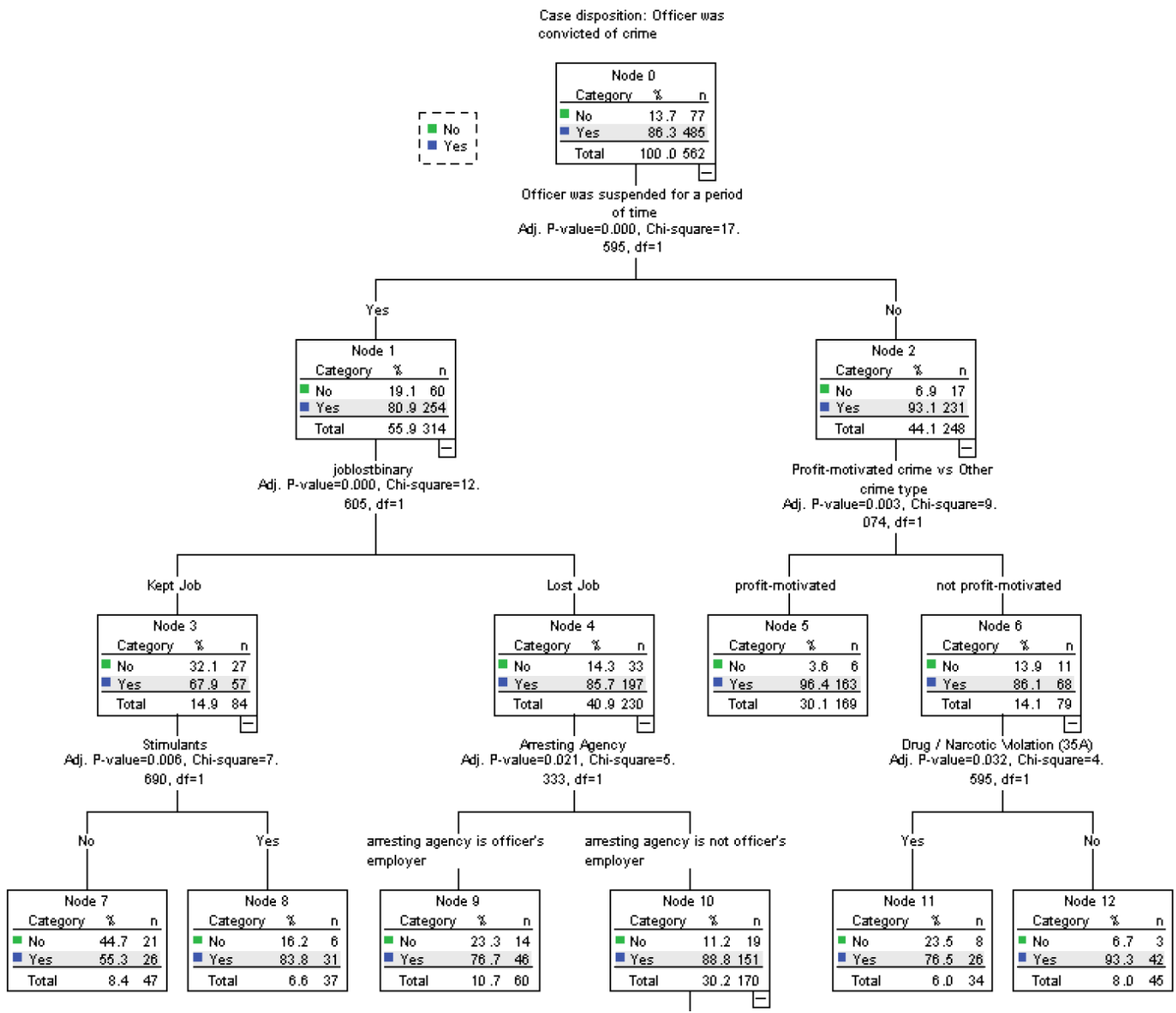

Figure 20. Drug-related Arrest Cases: CART Model Predicting Conviction

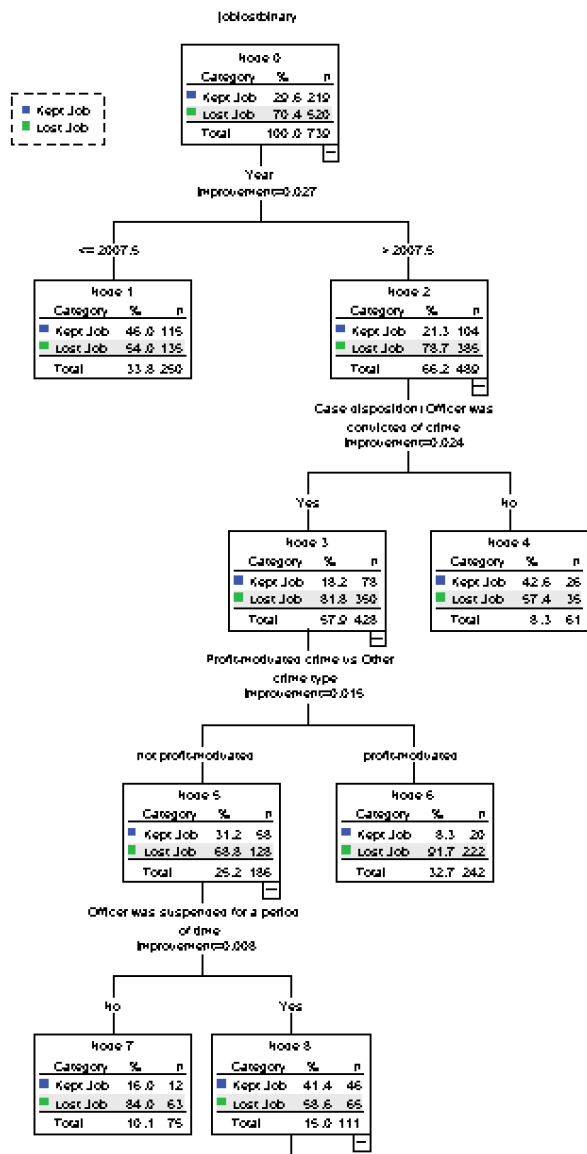

Figure 21. Drug-related Arrest Cases: CART Model Predicting Job Loss

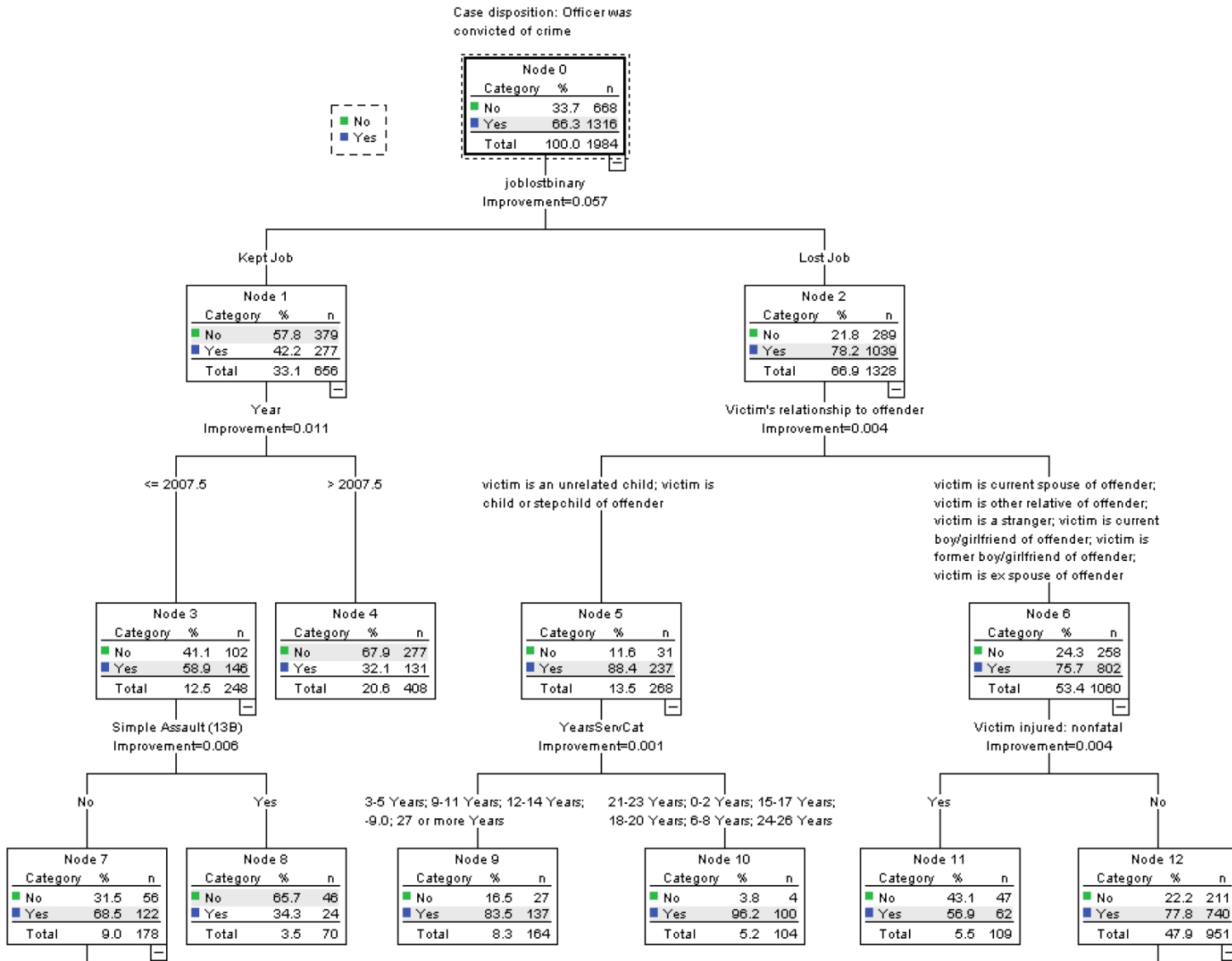

Figure 22. Violence-related Arrest Cases: CART Model Predicting Conviction

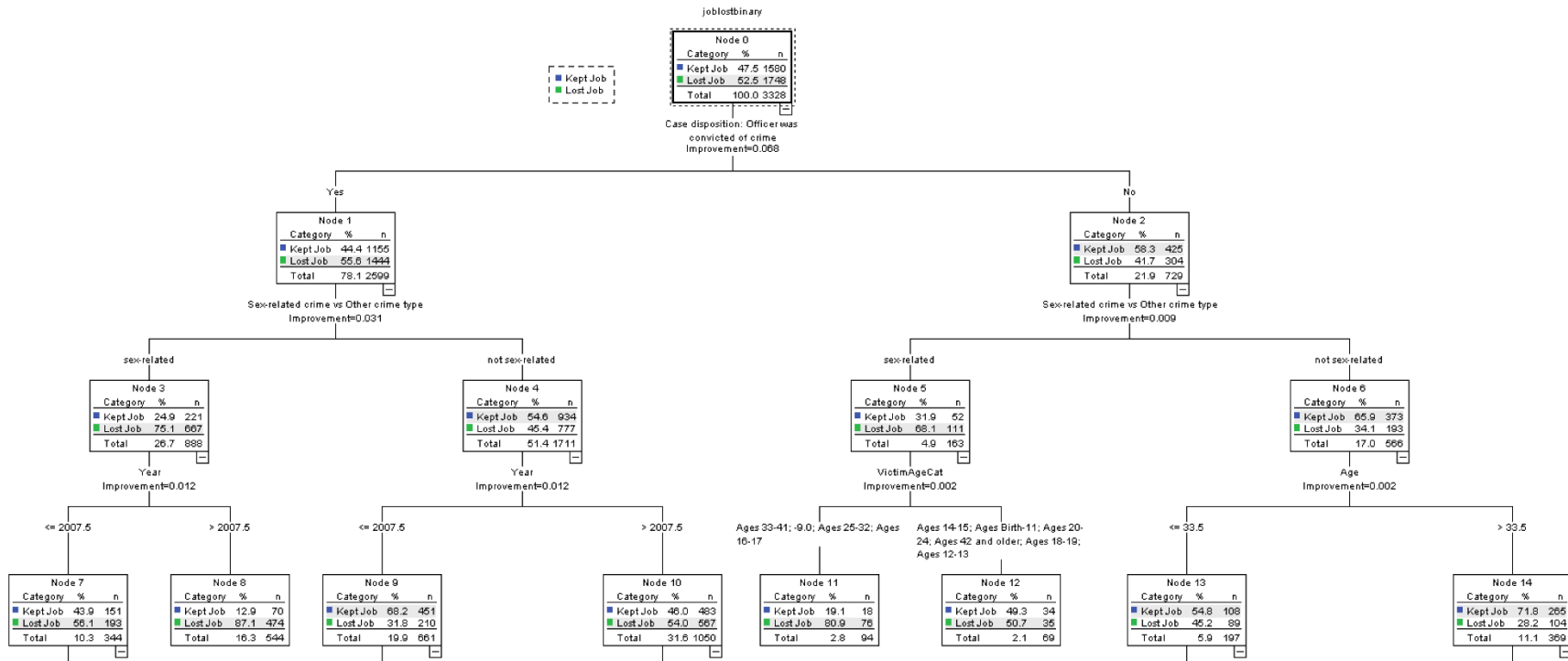

Figure 23. Violence-related Arrest Cases: CART Model Predicting Job Loss

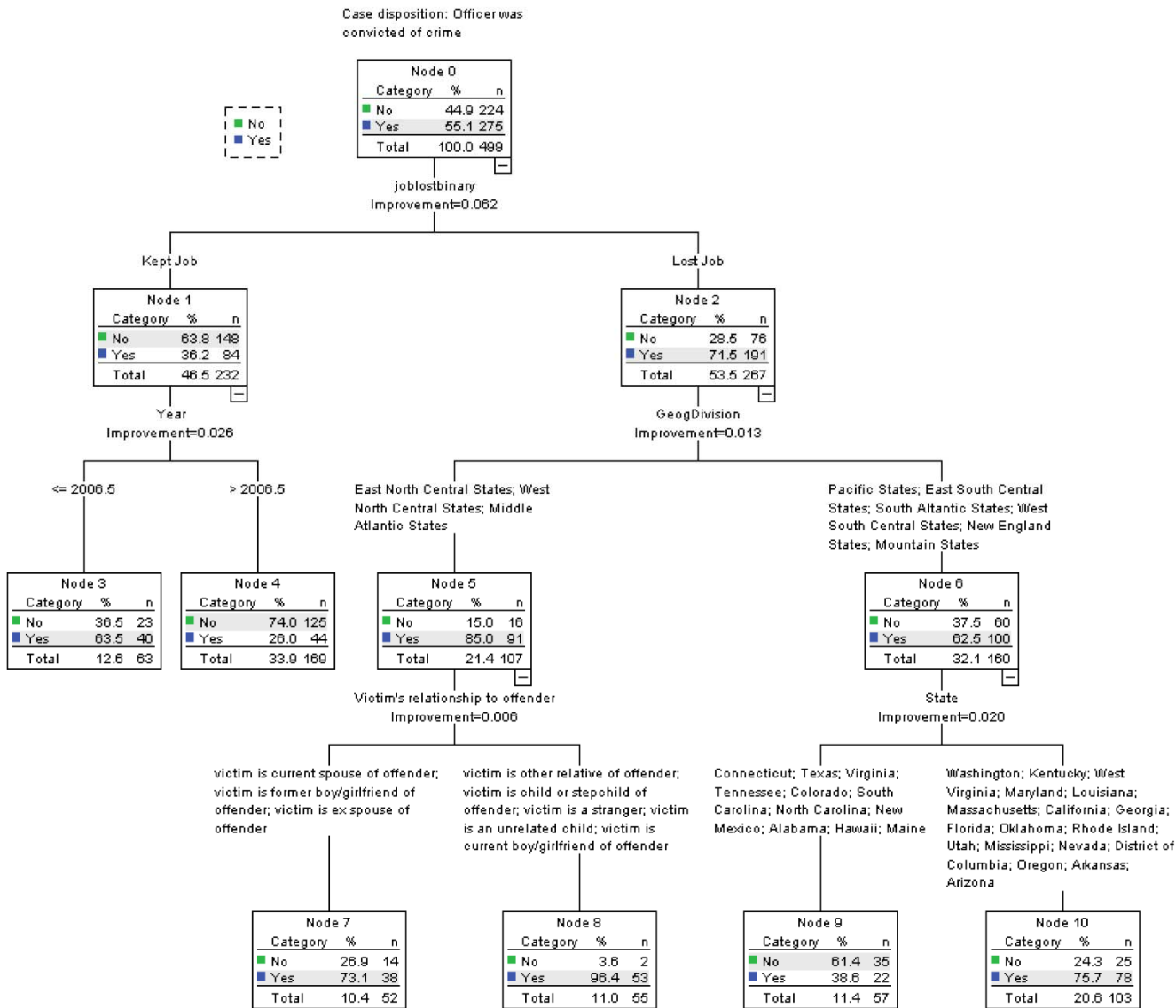

Figure 24. Officer-involved Domestic Violence Arrest Cases: CART Model Predicting Conviction

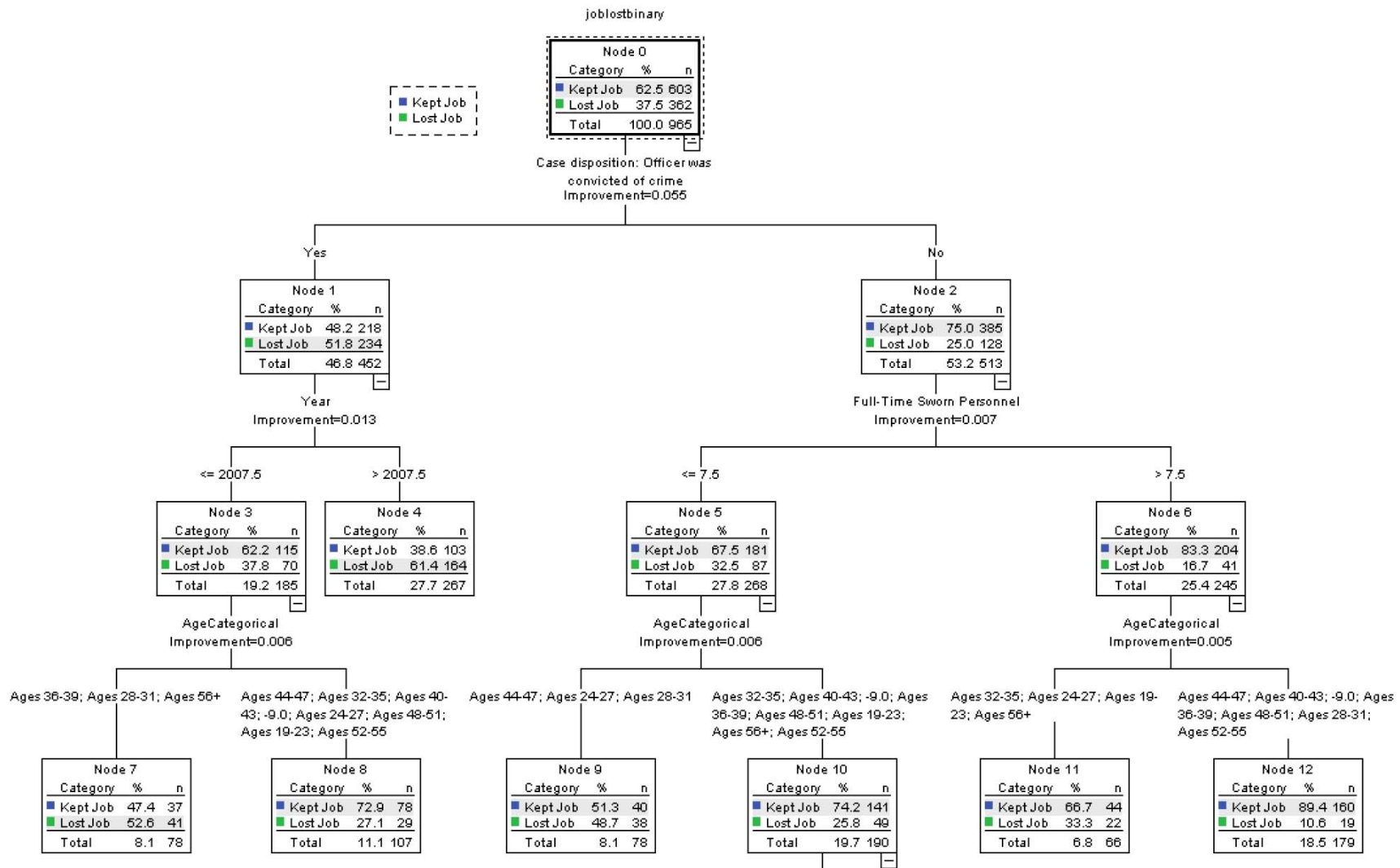

Figure 25. Officer-involved Domestic Violence Arrest Cases: CART Model Predicting Job Loss

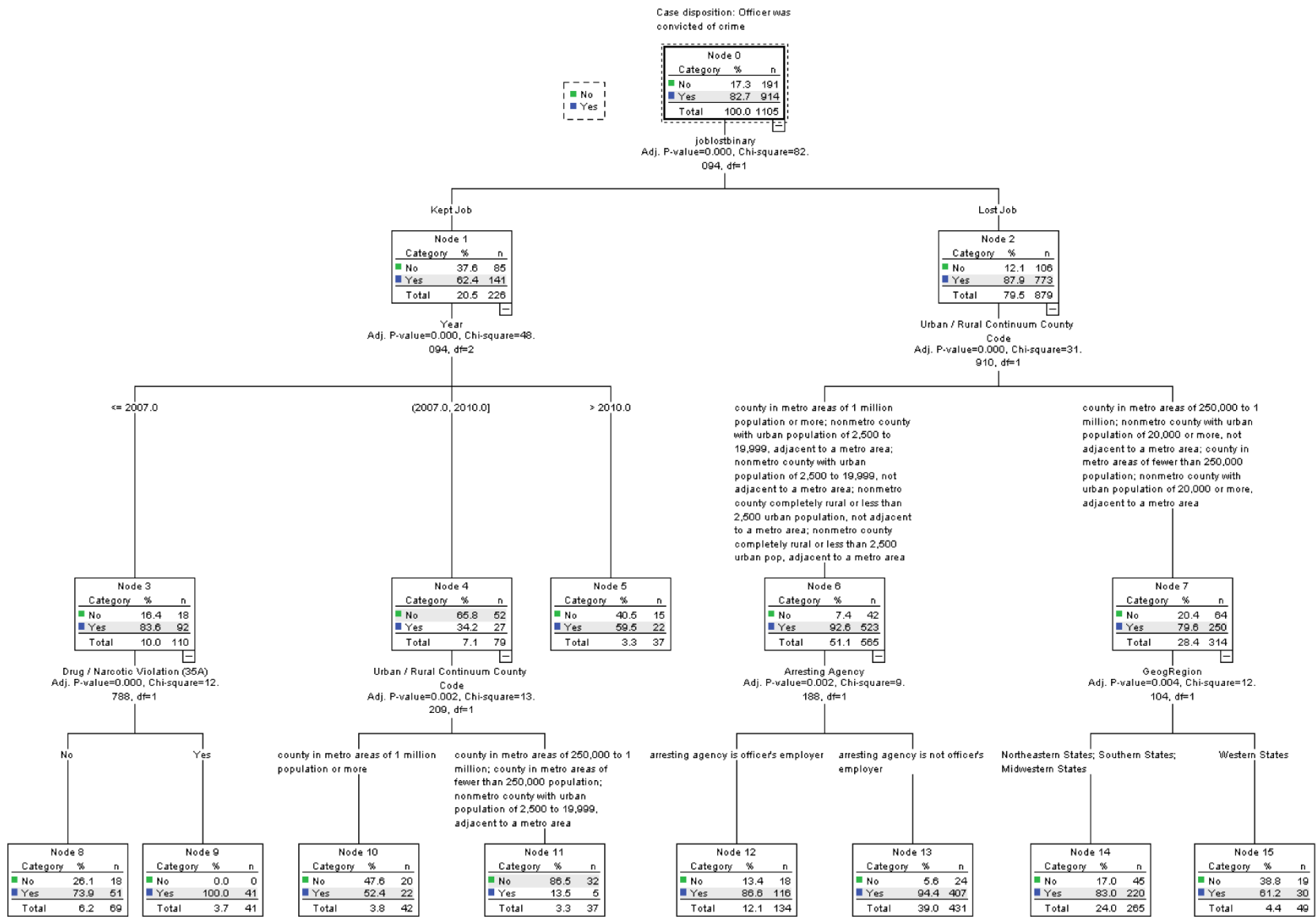

Figure 26. Profit-motivated Arrest Cases: CART Model Predicting Conviction

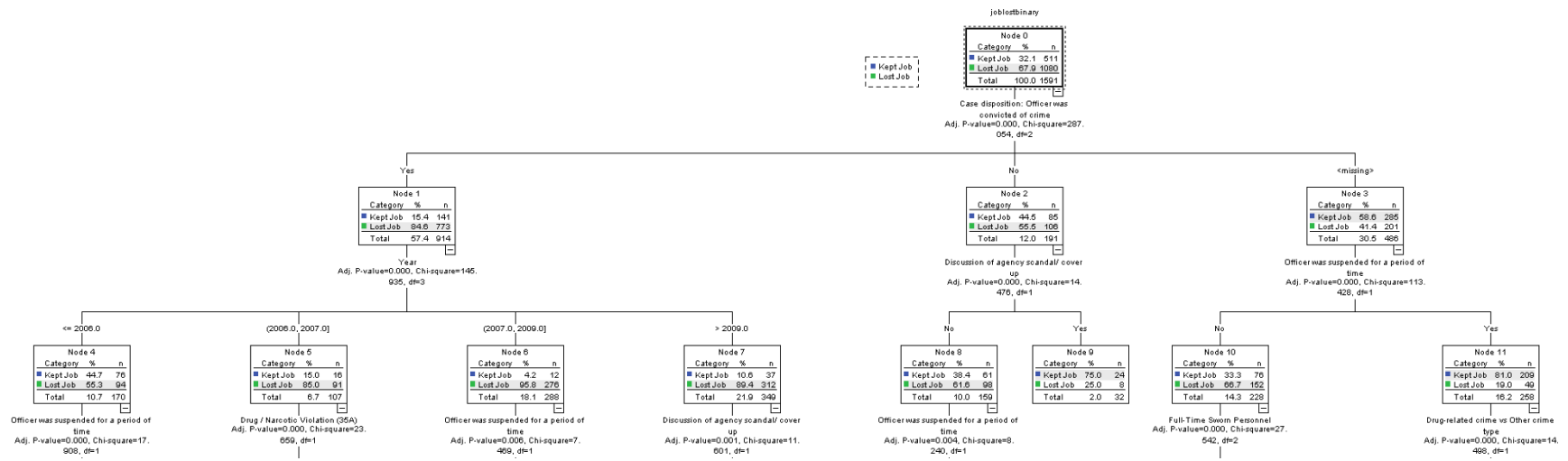

Figure 27. Profit-motivated Arrest Cases: CART Model Predicting Job Loss

Appendix A-1. Nonmetropolitan State & Local Law Enforcement Agencies in Study: Rates of Officers Arrested, 2005-2011 (Sorted by # FT Sworn)

Agency	County	State	# of Full-Time Sworn Personnel	Per Agency	Per 1,000 Officers	Per 100,000 Population
Navajo Nation Tribal Dept of Law Enforcement	Apache	AZ	393	3	7.63	4.19
Monroe County Sheriff's Office	Monroe	FL	189	3	15.87	4.10
New York City Dept of Env. Protection Police	Westchester	NY	168	1	5.95	1.29
Robeson County Sheriff's Office	Robeson	NC	128	3	23.44	2.24
Danville Police Department	Pittsylvania	VA	126	1	7.94	1.57
Kauai (County) Police Department	Kauai	HI	125	3	24.00	4.47
Sauk County Sheriff's Office	Sauk	WI	118	1	8.47	1.61
Tupelo Police Department	Lee	MS	115	1	8.70	1.21
Wilson Police Department	Wilson	NC	114	2	17.54	2.46
Henry County Sheriff's Office	Henry	VA	112	14	125.00	25.85
Nye County Sheriff's Office	Nye	NV	108	3	27.78	6.83
Douglas County Sheriff's Office	Douglas	NV	100	1	10.00	2.13
Meridian Police Department	Lauderdale	MS	99	3	30.30	3.74
Greenville Police Department	Washington	MS	96	2	20.83	3.91
Orangeburg County Sheriff's Office	Orangeburg	SC	92	1	10.87	1.08
Muskogee Police Department	Muskogee	OK	90	4	44.44	5.63
St. Landry Parish Sheriff's Office	St. Landry	LA	90	4	44.44	4.80
LaGrange Police Department	Troup	GA	83	1	12.05	1.49
Sanford Police Department	Lee	NC	81	1	12.35	1.73
Roswell Police Department	Chaves	NM	80	2	25.00	3.05
Torrington Police Department	Litchfield	CT	79	1	12.66	0.53
Cullman County Sheriff's Office	Cullman	AL	78	1	12.82	1.24
Georgetown County Sheriff's Office	Georgetown	SC	78	1	12.82	1.66
Concord Police Department	Merrimack	NH	77	1	12.99	0.68
Stillwater Police Department	Payne	OK	74	1	13.51	1.29
Lumberton Police Department	Robeson	NC	73	1	13.70	0.75
Orangeburg Public Safety	Orangeburg	SC	72	3	41.67	3.24
Alamogordo Department of Public Safety	Otero	NM	71	1	14.08	1.57
Auburn Police Department	Cayuga	NY	70	1	14.29	1.25
Cookeville Police Department	Putnam	TN	70	2	28.57	2.77
Shelby Police Department	Cleveland	NC	70	1	14.29	1.02

Danville (City) Sheriff's Office	Danville City	VA	69	3	43.48	6.97
Hendry County Sheriff's Office	Hendry	FL	67	1	14.93	2.55
Del Rio Police Department	Val Verde	TX	65	1	15.38	2.05
Frankfort Police Department	Franklin	KY	65	1	15.38	2.03
Lincoln County Sheriff's Office	Lincoln	OR	65	1	15.38	2.17
Richmond Police Department	Madison	KY	65	1	15.38	1.21
Grand Traverse County Sheriff's Office	Grand Traverse	MI	64	2	31.25	2.30
Manitowoc Police Department	Manitowoc	WI	64	2	31.25	2.46
Twin Falls Police Department	Twin Falls	ID	64	1	15.63	1.29
Vernon Parish Sheriff's Office	Vernon	LA	64	2	31.25	3.82
Columbus Police Department	Lowndes	MS	62	1	16.13	1.67
Gallup Police Department	McKinley	NM	62	1	16.13	1.40
Jamestown Police Department	Chautauqua	NY	62	2	32.26	1.48
Jackson County Sheriff's Office	Jackson	FL	61	1	16.39	2.01
Lake County Sheriff's Office	Lake	CA	61	2	32.79	3.09
Nogales Police Department	Santa Cruz	AZ	60	2	33.33	4.22
Virginia Marine Resources Commission	Newport News City	VA	60	1	16.67	3.02
Allegan County Sheriff's Office	Allegan	MI	59	1	16.95	0.90
Campbell County Sheriff's Office	Campbell	WY	58	1	17.24	2.17
Lenoir County Sheriff's Office	Lenoir	NC	58	2	34.48	3.36
Opelousas Police Department	St. Landry	LA	58	1	17.24	1.20
Putnam County Sheriff's Office	Putnam	TN	58	2	34.48	2.77
Elko County Sheriff's Office	Elko	NV	57	1	17.54	2.05
Sevierville Police Department	Sevier	TN	55	1	18.18	1.11
Bartlesville Police Department	Washington	OK	54	4	74.07	7.85
Paris Police Department	Lamar	TX	54	1	18.52	2.01
Sandusky Police Department	Erie	OH	54	2	37.04	2.59
Clovis Police Department	Curry	NM	53	3	56.60	6.20
Galesburg Police Dept	Knox	IL	53	1	18.87	1.89
Zanesville Police Department	Muskingum	OH	53	3	56.60	3.49
Shawnee Police Department	Pottawatomie	OK	52	1	19.23	1.44
Kerrville Police Department	Kerr	TX	51	1	19.61	2.02
Assumption Parish Sheriff's Office	Assumption	LA	50	2	40.00	8.54
Durango Police Department	La Plata	CO	50	1	20.00	1.95
Selma Police Department	Dallas	AL	50	2	40.00	4.56
Dodge City Police Department	Ford	KS	49	1	20.41	2.95

Page County Sheriff's Office	Page	VA	49	1	20.41	4.16
Stanly County Sheriff's Office	Stanly	NC	49	1	20.41	1.65
Cherokee County Sheriff's Office	Cherokee	SC	48	2	41.67	3.61
Natchez Police Dept.	Adams	MS	48	4	83.33	12.39
Chillicothe Police Department	Ross	OH	47	1	21.28	1.28
Lee County Sheriff's Office	Lee	NC	47	1	21.28	1.73
Plattsburgh Police Department	Clinton	NY	47	1	21.28	1.22
Thomas County Sheriff's Office	Thomas	GA	47	2	42.55	4.47
Eureka Police Department	Humboldt	CA	46	1	21.74	0.74
Lincoln Parish Sheriff's Office	Lincoln	LA	46	1	21.74	2.14
Mason City Police Department	Cerro Gordo	IA	46	1	21.74	2.26
New Milford Police Department	Litchfield	CT	46	1	21.74	0.53
Butte - Silver Bow County Sheriff's Office	Silver Bow	MT	45	2	44.44	5.85
Gatlinburg Police Department	Sevier	TN	45	1	22.22	1.11
Gillette Police Department	Campbell	WY	45	1	22.22	2.17
Grant County Sheriff's Office	Grant	IN	45	1	22.22	1.43
Harrison County Sheriff's Office	Harrison	TX	45	1	22.22	1.52
Juneau County Sheriff's Office	Juneau	WI	45	1	22.22	3.75
Kingsville Police Department	Kleberg	TX	45	1	22.22	3.12
Natchitoches Parish Sheriff's Office	Natchitoches	LA	45	1	22.22	2.53
Calhoun Police Department	Gordon	GA	44	1	22.73	1.81
Cortland Police Department	Cortland	NY	44	1	22.73	2.03
Juneau Police Dept.	Juneau	AK	44	1	22.73	3.20
Lenawee County Sheriff's Office	Lenawee	MI	44	1	22.73	1.00
Saline County Sheriff's Office	Saline	KS	44	1	22.73	1.80
Scottsboro Police Department	Jackson	AL	44	1	22.73	1.88
Sedalia Police Dept	Pettis	MO	44	1	22.73	2.37
Sullivan County Sheriff's Office	Sullivan	NY	44	1	22.73	1.29
Zapata County Sheriff's Office	Zapata	TX	44	1	22.73	7.13
Kingsland Police Dept	Camden	GA	43	1	23.26	1.98
Poplar Bluff Police Department	Butler	MO	43	1	23.26	2.34
Ada Police Department	Pontotoc	OK	42	1	23.81	2.67
Saline County Sheriff's Office	Saline	IL	42	1	23.81	4.01
Chesterfield County Sheriff's Office	Chesterfield	SC	41	1	24.39	2.14
Rutland Police Department.	Rutland	VT	41	1	24.39	1.62
Searcy Police Department	White	AR	41	1	24.39	1.30

Bainbridge Police Department	Decatur	GA	40	2	50.00	7.18
Big Spring Police Department	Howard	TX	40	1	25.00	2.86
McDowell County Sheriff's Office	McDowell	NC	40	1	25.00	2.22
White County Sheriff's Office	White	GA	40	1	25.00	3.68
Corinth Police Department	Alcorn	MS	39	1	25.64	2.70
Klamath Falls Police Department	Klamath	OR	39	1	25.64	1.51
Muscatine Police Department	Muscatine	IA	39	1	25.64	2.34
Seymour Police	Jackson	IN	39	1	25.64	2.36
Boone Police Department	Watauga	NC	38	1	26.32	1.96
Brownwood Police Department	Brown	TX	38	2	52.63	5.25
Mount Airy Police Department	Surry	NC	38	1	26.32	1.36
Alice Police Department	Jim Wells	TX	37	1	27.03	2.45
Bogalusa Police Department	Washington	LA	37	1	27.03	2.12
Dunn Police Department	Harnett	NC	37	1	27.03	0.87
Fort Dodge Police Department	Webster	IA	37	1	27.03	2.63
Gaffney Police Department	Cherokee	SC	37	2	54.05	3.61
Muskogee County Sheriff's Office	Muskogee	OK	37	1	27.03	1.41
Palatka Police Department	Putnam	FL	37	1	27.03	1.34
Bennettsville Police Department	Marlboro	SC	36	1	27.78	3.46
Durant Police Department	Bryan	OK	36	1	27.78	2.36
Hastings Police Dept	Adams	NE	36	2	55.56	6.38
Kalispell Police Department	Flathead	MT	36	1	27.78	1.10
La Salle County Sheriff's Office	La Salle	IL	36	1	27.78	0.88
Union City Police Department	Obion	TN	36	1	27.78	3.14
Washington Police Department	Beaufort	NC	36	1	27.78	2.09
Clarksdale Police Department	Coahoma	MS	35	1	28.57	3.82
Lebanon Police Department	Grafton	NH	35	1	28.57	1.12
McKinley County Sheriff's Office	McKinley	NM	35	1	28.57	1.40
New Castle (city) Police Department	Lawrence	PA	35	1	28.57	1.10
New Castle Police	Henry	IN	35	1	28.57	2.02
Polk County Police Department	Polk	GA	35	3	85.71	7.23
DeKalb County Sheriff's Office	DeKalb	AL	34	1	29.41	1.41
Fort Payne Police Department	DeKalb	AL	34	1	29.41	1.41
Martin County Sheriff's Office	Martin	NC	34	1	29.41	4.08
Plainview Police Department	Hale	TX	34	1	29.41	2.76
Seneca Police Department	Oconee	SC	34	1	29.41	1.35

Holmes County Sheriff's Office	Holmes	OH	33	1	30.30	2.36
Tuskegee University Police Department	Macon	AL	33	1	30.30	4.66
Baxter County Sheriff's Office	Baxter	AR	32	1	31.25	2.41
Eunice Police Department	St. Landry	LA	32	5	156.25	6.00
Moberly Police Department	Randolph	MO	32	1	31.25	3.93
Olean Police Department	Cattaraugus	NY	32	1	31.25	1.25
Tahlequah Police Department	Cherokee	OK	32	1	31.25	2.13
Traverse City Police Department	Grand Traverse	MI	32	1	31.25	1.15
Austin Police Department	Mower	MN	31	1	32.26	2.55
Murray Police Department	Calloway	KY	31	1	32.26	2.69
Starr County Sheriff's Office	Starr	TX	31	1	32.26	1.64
Stephens County Sheriff's Office	Stephens	GA	31	1	32.26	3.82
Andalusia Police Dept.	Covington	AL	30	1	33.33	2.65
Berea Police Department	Madison	KY	30	1	33.33	1.21
Del Norte County Sheriff's Office	Del Norte	CA	30	2	66.67	6.99
Great Bend Police Department	Barton	KS	30	1	33.33	3.61
Greenbrier County Sheriff's Office	Greenbrier	WV	30	1	33.33	2.82
Helena/West Helena Police Department	Phillips	AR	30	4	133.33	18.38
Kings Mountain Police Department	Cleveland	NC	30	2	66.67	2.04
Lebanon Police Department	Laclede	MO	30	1	33.33	2.81
Luna County Sheriff's Office	Luna	NM	30	1	33.33	3.98
Miami Police Department	Ottawa	OK	30	1	33.33	3.14
Mineral Wells Police Department	Palo Pinto	TX	30	2	66.67	7.11
Okanogan County Sheriff's Office	Okanogan	WA	30	1	33.33	2.43
Otero County Sheriff's Office	Otero	NM	30	1	33.33	1.57
Scottsbluff Police Dept	Scotts Bluff	NE	30	1	33.33	2.70
Shelby County Sheriff's Office	Shelby	OH	30	1	33.33	2.02
Warren County Sheriff's Office	Warren	NC	30	1	33.33	4.77
Albert Lea Police Department	Freeborn	MN	29	1	34.48	3.20
Halifax County Sheriff's Office	Halifax	VA	29	1	34.48	2.76
Mount Pleasant Police Department	Titus	TX	29	1	34.48	3.09
Ravalli County Sheriff's Office	Ravalli	MT	29	1	34.48	2.49
Hooksett Police Department	Merrimack	NH	28	1	35.71	0.68
Lee County Sheriff's Office	Lee	SC	28	1	35.71	5.20
Leesville Police Department	Vernon	LA	28	1	35.71	1.91
Vail Police Department	Eagle	CO	28	1	35.71	1.92

White County Sheriff's Office	White	TN	28	1	35.71	3.87
Accomack County Sheriff's Office	Accomack	VA	27	1	37.04	3.02
Farmville Police Department	Prince Edward	VA	27	1	37.04	4.28
Jim Wells County Sheriff's Office	Jim Wells	TX	27	1	37.04	2.45
Las Vegas Police Department	San Miguel	NM	27	1	37.04	3.40
Marble Falls Police Department	Burnet	TX	27	1	37.04	2.34
Marion County Sheriff's Office	Marion	WV	27	1	37.04	1.77
Philadelphia Police Department	Neshoba	MS	27	1	37.04	3.37
Polk County Sheriff's Office	Polk	GA	27	2	74.07	4.82
Rosebud Sioux Tribal Police	Todd	SD	27	1	37.04	10.40
Emery County Sheriff's Office	Emery	UT	26	2	76.92	18.22
Hampton County Sheriff's Office	Hampton	SC	26	1	38.46	4.74
Humboldt Police Department	Gibson	TN	26	2	76.92	4.03
Ruidoso Police Department	Lincoln	NM	26	1	38.46	4.88
Steuben County Sheriff's Office	Steuben	NY	26	1	38.46	1.01
Appalachian State University Police Dept	Watauga	NC	25	1	40.00	1.96
Dillon Police Department	Dillon	SC	25	1	40.00	3.12
Lawrence County Sheriff's Office	Lawrence	IN	25	1	40.00	2.17
Marlboro County Sheriff's Office	Marlboro	SC	25	2	80.00	6.91
Newaygo County Sheriff's Office	Newaygo	MI	25	1	40.00	2.06
Ogdensburg Police Department	St. Lawrence	NY	25	1	40.00	0.89
Russellville Police Department	Franklin	AL	25	2	80.00	6.31
Sault Ste. Marie Police Department	Chippewa	MI	25	1	40.00	2.60
Tuscola County Sheriff's Office	Tuscola	MI	25	1	40.00	1.79
Commerce Police Department	Jackson	GA	24	1	41.67	1.65
Deridder Police Department	Beauregard	LA	24	1	41.67	2.80
Huron Police Department	Beadle	SD	24	1	41.67	5.75
Jennings Police Department	Jefferson Davis	LA	24	1	41.67	3.17
Marion Police Department	Marion	SC	24	1	41.67	3.02
Aspen Police Department	Pitkin	CO	23	2	86.96	11.66
Beeville Police Department	Bee	TX	23	1	43.48	3.14
Canton Police Dept	Fulton	IL	23	1	43.48	2.70
Emmet County Sheriff's Office	Emmet	MI	23	1	43.48	3.06
Graham County Sheriff's Office	Graham	AZ	23	1	43.48	2.69
Monroe County Sheriff's Office	Monroe	WI	23	1	43.48	2.24
Seneca County Sheriff's Office	Seneca	NY	23	6	260.87	17.02

Tuskegee Police Department	Macon	AL	23	2	86.96	9.32
Winn Parish Sheriff's Office	Winn	LA	23	1	43.48	6.53
Columbiana County Sheriff's Office	Columbiana	OH	22	2	90.91	1.85
Craig Police Department	Moffat	CO	22	1	45.45	7.25
Fayette County Sheriff's Office	Fayette	OH	22	3	136.36	10.33
Hardeman County Sheriff's Office	Hardeman	TN	22	1	45.45	3.67
Haywood County Sheriff's Office	Haywood	TN	22	1	45.45	5.32
Hornell Police Department	Steuben	NY	22	1	45.45	1.01
Indiana Borough Police Department	Indiana	PA	22	1	45.45	1.13
Ketchikan Police Dept.	Ketchikan Gateway	AK	22	1	45.45	7.42
Ontario Police Department	Malheur	OR	22	1	45.45	3.19
Rio Arriba County Sheriff's Office	Rio Arriba	NM	22	1	45.45	2.48
Routt County Sheriff's Office	Routt	CO	22	1	45.45	4.25
Vernal Police Department	Uintah	UT	22	1	45.45	3.07
Washington Court House Police Dept.	Fayette	OH	22	1	45.45	3.44
Bluefield Police Department	Mercer	WV	21	1	47.62	1.61
Bolivar Police Department	Hardeman	TN	21	1	47.62	3.67
Caruthersville Police Department	Pemiscot	MO	21	2	95.24	10.93
Central Michigan University Police Department	Isabella	MI	21	1	47.62	1.42
Clearlake Police Department	Lake	CA	21	1	47.62	1.55
Mason County Sheriff's Office	Mason	WV	21	3	142.86	10.98
San Jacinto County Sheriff's Office	San Jacinto	TX	21	1	47.62	3.79
Clewiston Police Department	Hendry	FL	20	2	100.00	5.11
Marksville Police Department	Avoyelles	LA	20	1	50.00	2.38
Oakdale Police Department	Allen	LA	20	1	50.00	3.88
Platteville Police Department	Grant	WI	20	1	50.00	1.95
Vidalia Police Department	Concordia	LA	20	1	50.00	4.80
Wilkesboro Police Department	Wilkes	NC	20	1	50.00	1.44
Conneaut Police Department	Ashtabula	OH	19	1	52.63	0.99
Corbin Police Department	Whitley	KY	19	1	52.63	2.81
Daviess County Sheriff's Office	Daviess	IN	19	1	52.63	3.16
Delavan Police Department	Walworth	WI	19	1	52.63	0.98
Demopolis Police Department	Marengo	AL	19	1	52.63	4.76
Norwich Police Department	Chenango	NY	19	1	52.63	1.98
Sturgis Police Department	St. Joseph	MI	19	1	52.63	1.63
Barre Police Department	Washington	VT	18	1	55.56	1.68

Black Mountain Police Department	Buncombe	NC	18	1	55.56	2.22
Bolivar County Sheriff's Office	Bolivar	MS	18	1	55.56	2.93
Calhoun County Sheriff's Office	Calhoun	FL	18	1	55.56	6.84
Duval County Sheriff's Office	Duval	TX	18	1	55.56	8.49
Greensburg Police	Decatur	IN	18	1	55.56	3.89
Kendallville Police	Noble	IN	18	1	55.56	2.10
Leland Police Department	Washington	MS	18	1	55.56	1.96
Marion Police Department	Smyth	VA	18	1	55.56	3.10
Osceola County Sheriff's Office	Osceola	MI	18	1	55.56	4.25
Rockmart Police Department	Polk	GA	18	1	55.56	2.41
Seaside Police Department	Clatsop	OR	18	1	55.56	2.70
Selmer Police Department	McNairy	TN	18	1	55.56	3.84
Spencer Police Department	Clay	IA	18	1	55.56	6.00
Sweetwater Police Department	Monroe	TN	18	1	55.56	2.25
Towns County Sheriff's Office	Towns	GA	18	1	55.56	9.55
Winnemucca Police Department	Humboldt	NV	18	1	55.56	6.05
Cross County Sheriff's Office	Cross	AR	17	1	58.82	5.60
Elkin Police Department	Surry	NC	17	1	58.82	1.36
Fort Madison Police Department	Lee	IA	17	1	58.82	2.79
Kitty Hawk Police Department	Dare	NC	17	1	58.82	2.95
McIntosh County Sheriff's Office	McIntosh	OK	17	2	117.65	9.88
Middlesex County Sheriff's Office	Middlesex	VA	17	1	58.82	9.12
Princeton Police Department	Mercer	WV	17	2	117.65	3.21
Bishopville Police Department	Lee	SC	16	1	62.50	5.20
Eatonton Police Department	Putnam	GA	16	1	62.50	4.71
Harrodsburg Police Department	Mercer	KY	16	1	62.50	4.69
Lamesa Police Department	Dawson	TX	16	1	62.50	7.23
Miller County Sheriff's Office	Miller	MO	16	1	62.50	4.04
Phillips County Sheriff's Office	Phillips	AR	16	1	62.50	4.60
Red Springs Police Department	Robeson	NC	16	1	62.50	0.75
Crossett Police Department	Ashley	AR	15	1	66.67	4.58
Ephrata Police Department	Grant	WA	15	1	66.67	1.12
Greene County Sheriff's Office	Greene	AR	15	1	66.67	2.38
McDowell County Sheriff's Office	McDowell	WV	15	1	66.67	4.52
Moab Police Department	Grand	UT	15	1	66.67	10.84
Nashville Police Department	Berrien	GA	15	1	66.67	5.19

Nebraska City Police Dept	Otoe	NE	15	2	133.33	12.71
Royston Police Department	Franklin	GA	15	1	66.67	4.53
Shelby County Sheriff's Office	Shelby	TX	15	2	133.33	7.86
Springfield Police Department	Windsor	VT	15	1	66.67	1.76
St. Marys Police Department	Auglaize	OH	15	1	66.67	2.18
Thief River Falls Police Department	Pennington	MN	15	1	66.67	7.18
Vinita Police Department	Craig	OK	15	1	66.67	6.65
Appling County Sheriff's Office	Appling	GA	14	1	71.43	5.48
Caribou Police Department	Aroostook	ME	14	1	71.43	1.39
Clyde Police Department	Sandusky	OH	14	1	71.43	1.64
Cochran Police Department	Bleckley	GA	14	3	214.29	22.97
Grants Police Department	Cibola	NM	14	1	71.43	3.67
Jackson County Sheriff's Office	Jackson	TN	14	3	214.29	25.78
Morrow County Sheriff's Office	Morrow	OR	14	1	71.43	8.95
Newport Police Department	Sullivan	NH	14	1	71.43	2.29
Ocean Shores Police Department	Grays Harbor	WA	14	1	71.43	1.37
Pelham Police Department	Mitchell	GA	14	1	71.43	4.26
Benzie County Sheriff's Office	Benzie	MI	13	1	76.92	5.71
Denton Police Department	Caroline	MD	13	1	76.92	3.02
Fairmont Police Department	Robeson	NC	13	1	76.92	0.75
Frisco Police Department	Summit	CO	13	1	76.92	3.57
Hempstead County Sheriff's Office	Hempstead	AR	13	1	76.92	4.42
Pauls Valley Police Department	Garvin	OK	13	1	76.92	3.63
Randolph County Sheriff's Office	Randolph	IL	13	1	76.92	2.99
Tucumcari Police Department	Quay	NM	13	1	76.92	11.06
Upper Sandusky Police Department	Wyandot	OH	13	1	76.92	4.42
Winnfield Police Dept	Winn	LA	13	1	76.92	6.53
Braselton Police Department	Jackson	GA	12	1	83.33	1.65
Bunkie Police Department	Avoyelles	LA	12	1	83.33	2.38
Clayton County Sheriff's Office	Clayton	IA	12	1	83.33	5.52
Custer County Sheriff's Office	Custer	OK	12	1	83.33	3.64
Edenton Police Department	Chowan	NC	12	3	250.00	20.28
Fayette Police Department	Fayette	AL	12	1	83.33	5.80
Franklin County Sheriff's Office	Franklin	IN	12	1	83.33	4.33
Gage County Sheriff's Office	Gage	NE	12	1	83.33	4.48
Lakeport Police Department	Lake	CA	12	1	83.33	1.55

Madill Police Department	Marshall	OK	12	1	83.33	6.31
Monticello Police	White	IN	12	1	83.33	4.06
Perry County Sheriff's Office	Perry	IL	12	1	83.33	4.47
Quincy Police Department	Grant	WA	12	1	83.33	1.12
Wallace Police Department	Duplin	NC	12	1	83.33	1.71
Whitley County Sheriff's Office	Whitley	KY	12	1	83.33	2.81
Williamsburg Police Department	Whitley	KY	12	1	83.33	2.81
Wolfeboro Police Department	Carroll	NH	12	1	83.33	2.09
Algood Police Department	Putnam	TN	11	1	90.91	1.38
Crystal City Police Department	Zavala	TX	11	4	363.64	34.26
Eastman Police Department	Dodge	GA	11	1	90.91	4.59
Floyd County Sheriff's Office	Floyd	IA	11	1	90.91	6.13
Fort Gibson Police Department	Muskogee	OK	11	1	90.91	1.41
Greene County Sheriff's Office	Greene	AL	11	1	90.91	11.06
Hannahville Tribal Police Department	Menominee	MI	11	1	90.91	4.16
Hockley County Sheriff's Office	Hockley	TX	11	2	181.82	8.72
Medina Police Department	Gibson	TN	11	1	90.91	2.01
Missouri University of Science & Tech Police Dept	Phelps	MO	11	1	90.91	2.21
Montezuma Police Department	Macon	GA	11	2	181.82	13.57
Pulaski County Sheriff's Office	Pulaski	IL	11	2	181.82	32.46
Rainsville Police Department	DeKalb	AL	11	1	90.91	1.41
Roosevelt County Sheriff's Office	Roosevelt	MT	11	1	90.91	9.59
Simpson County Sheriff's Office	Simpson	KY	11	1	90.91	5.77
Stark County Sheriff's Office	Stark	ND	11	1	90.91	4.13
Stephens County Sheriff's Office	Stephens	OK	11	2	181.82	4.44
Allendale Police Department	Allendale	SC	10	2	200.00	19.20
Allenstown Police Department	Merrimack	NH	10	1	100.00	0.68
Alma Police Department	Bacon	GA	10	1	100.00	9.01
BYU-Idaho Police Department	Madison	ID	10	1	100.00	2.66
Columbus Police Department	Colorado	TX	10	1	100.00	4.79
Creston Police Department	Union	IA	10	2	200.00	15.96
Dewitt Police Department	Clinton	IA	10	1	100.00	2.04
Ferriday Police Department	Concordia	LA	10	1	100.00	4.80
Ferry County Sheriff's Office	Ferry	WA	10	1	100.00	13.24
Helen Police Department	White	GA	10	1	100.00	3.68
Ishpeming Police Department	Marquette	MI	10	1	100.00	1.49

Jaffrey Police Department	Cheshire	NH	10	1	100.00	1.30
Kermit Police Department	Winkler	TX	10	1	100.00	14.06
La Salle County Sheriff's Office	La Salle	TX	10	3	300.00	43.57
Lancaster Police Department	Garrard	KY	10	1	100.00	5.91
Lander University Public Safety	Greenwood	SC	10	1	100.00	1.44
Marlow Police Department	Stephens	OK	10	1	100.00	2.22
Millersburg Police Department	Holmes	OH	10	1	100.00	2.36
Montague County Sheriff's Office	Montague	TX	10	1	100.00	5.07
New Martinsville Police Department	Wetzel	WV	10	1	100.00	6.03
Powell County Sheriff's Office	Powell	MT	10	1	100.00	14.23
Socorro County Sheriff's Office	Socorro	NM	10	1	100.00	5.60
St. George Police Department	Dorchester	SC	10	1	100.00	2.57
Williams Police Department	Colusa	CA	10	1	100.00	4.67
Winkler County Sheriff's Office	Winkler	TX	10	1	100.00	14.06
Andrews Police Department	Georgetown	SC	9	1	111.11	1.66
Arcade Police Department	Jackson	GA	9	1	111.11	1.65
Beardstown Police Dept	Cass	IL	9	1	111.11	7.33
Belpre Police Department	Washington	OH	9	1	111.11	1.62
Butler County Sheriff's Office	Butler	AL	9	3	333.33	14.32
Dillon Police Department	Summit	CO	9	1	111.11	3.57
Forest City Police Department	Winnebago	IA	9	1	111.11	9.20
Forks Police Department	Clallam	WA	9	1	111.11	1.40
Glendive Police Department	Dawson	MT	9	1	111.11	11.15
Grambling State University Police Dept.	Lincoln	LA	9	2	222.22	4.28
Hanceville Police Department	Cullman	AL	9	1	111.11	1.24
Lake County Sheriff's Office	Lake	CO	9	2	222.22	27.36
Lawrence Township Police Department	Clearfield	PA	9	1	111.11	1.22
Minocqua Police Department	Oneida	WI	9	1	111.11	2.78
Osceola Police Department	Clarke	IA	9	1	111.11	10.77
Ripley Police Department	Jackson	WV	9	1	111.11	3.42
Tabor City Police Department	Columbus	NC	9	2	222.22	3.44
Big Horn County Sheriff's Office	Big Horn	MT	8	1	125.00	7.77
Blackford County Sheriff's Office	Blackford	IN	8	1	125.00	7.83
Blountstown Police Dept.	Calhoun	FL	8	1	125.00	6.84
Canton Village Police Department	St. Lawrence	NY	8	1	125.00	0.89
Chandler Police Department	Henderson	TX	8	1	125.00	1.27

Eunice Police Department	Lea	NM	8	1	125.00	1.54
Kingfisher County Sheriff's Office	Kingfisher	OK	8	1	125.00	6.65
Madison County Sheriff's Office	Madison	MO	8	1	125.00	8.18
Oglesby Police Dept	La Salle	IL	8	1	125.00	0.88
Talbot County Sheriff's Office	Talbot	GA	8	3	375.00	43.70
Waynesburg Borough Police Department	Greene	PA	8	1	125.00	2.58
Whiteville Police Department	Hardeman	TN	8	1	125.00	3.67
Black River Falls Police Department	Jackson	WI	7	1	142.86	4.89
Byron Police Dept	Ogle	IL	7	1	142.86	1.87
Clay County Sheriff's Office	Clay	AR	7	1	142.86	6.22
Coeburn Police Department	Wise	VA	7	1	142.86	2.41
Flemingsburg Police Department	Fleming	KY	7	1	142.86	6.97
Fremont County Sheriff's Office	Fremont	IA	7	1	142.86	13.44
Haynesville Police Dept	Claiborne	LA	7	1	142.86	5.82
Hermann Police Department	Gasconade	MO	7	1	142.86	6.57
Holly Hill Police Department	Orangeburg	SC	7	1	142.86	1.08
Murphy Police Department	Cherokee	NC	7	1	142.86	3.64
New Castle Police Department	Garfield	CO	7	1	142.86	1.77
Port Barre Police Dept	St. Landry	LA	7	1	142.86	1.20
Providence Police Department	Webster	KY	7	1	142.86	7.34
Shelby Police Department	Bolivar	MS	7	2	285.71	5.86
Shenandoah Borough Police Department	Schuykill	PA	7	4	571.43	2.70
Shinnston Police Department	Harrison	WV	7	2	285.71	2.89
Union Police Department	Newton	MS	7	1	142.86	4.60
Winnsboro Police Department	Franklin	LA	7	1	142.86	4.82
Yemassee Police Department	Hampton	SC	7	1	142.86	4.74
Bingen-White Salmon Police Department	Klickitat	WA	6	1	166.67	4.92
Bridgeport Police Department	Jackson	AL	6	1	166.67	1.88
Chilhowie Police Department	Smyth	VA	6	4	666.67	12.42
Columbus Police Department	Polk	NC	6	1	166.67	4.88
East Brewton Police Department	Escambia	AL	6	1	166.67	2.61
Fairfax Police Department	Allendale	SC	6	1	166.67	9.60
Florala Police Department	Covington	AL	6	1	166.67	2.65
Geneva Township Police Department	Walworth	WI	6	1	166.67	0.98
Kaw Nation Tribal Police	Kay	OK	6	1	166.67	2.15
Norton Police Department	Norton	KS	6	1	166.67	17.63

Santee Police Department	Orangeburg	SC	6	2	333.33	2.16
Sleepy Eye Police Department	Redwood	MN	6	1	166.67	3.86
St. Paul Police Department	Wise	VA	6	1	166.67	2.41
University of West Alabama Police	Sumter	AL	6	1	166.67	7.27
Woodruff County Sheriff's Office	Woodruff	AR	6	1	166.67	13.77
Carlisle Police Department	Nicholas	KY	5	1	200.00	14.02
Chaffee Police Department	Scott	MO	5	1	200.00	2.55
Commerce Police Department	Ottawa	OK	5	1	200.00	3.14
Crescent City Police Department	Putnam	FL	5	1	200.00	1.34
Delhi Police Department	Richland	LA	5	1	200.00	4.83
Dixon Police Department	Pulaski	MO	5	1	200.00	1.91
Durand Police Department	Shiawassee	MI	5	1	200.00	1.42
Estill County Sheriff's Office	Estill	KY	5	1	200.00	6.82
Fryeburg Police Department	Oxford	ME	5	1	200.00	1.73
Grand Rapids Police Department	Wood	WI	5	1	200.00	1.34
Grant County Sheriff's Office	Grant	OK	5	1	200.00	22.09
Haskell Police Department	Muskogee	OK	5	1	200.00	1.41
Holt County Sheriff's Office	Holt	NE	5	1	200.00	9.58
Kenton Police Department	Obion	TN	5	1	200.00	3.14
Lake County Sheriff's Office	Lake	SD	5	1	200.00	8.93
Level Plains Police Department	Dale	AL	5	1	200.00	1.99
Lewis County Sheriff's Office	Lewis	MO	5	1	200.00	9.79
Middletown Police	Henry	IN	5	1	200.00	2.02
Montpelier Police Department	Bear Lake	ID	5	1	200.00	16.71
Mora County Sheriff's Office	Mora	NM	5	1	200.00	20.49
North Kingsville Police Department	Ashtabula	OH	5	1	200.00	0.99
Oglethorpe Police Department	Macon	GA	5	1	200.00	6.78
Olney Police Department	Young	TX	5	1	200.00	5.39
Oregon County Sheriff's Office	Oregon	MO	5	2	400.00	18.38
Pearson Police Department	Atkinson	GA	5	1	200.00	11.94
Pocahontas County Sheriff's Office	Pocahontas	WV	5	1	200.00	11.47
Ranger Police Department	Eastland	TX	5	1	200.00	5.38
Richland Police Dept	Pulaski	MO	5	1	200.00	1.91
Robbins Police Department	Moore	NC	5	1	200.00	1.13
Roseboro Police Department	Sampson	NC	5	2	400.00	3.15
Rosedale Police Department	Bolivar	MS	5	1	200.00	2.93

Santa Clara Police Department	Grant	NM	5	1	200.00	3.39
Sugarcreek Borough Police Department	Venango	PA	5	1	200.00	1.82
Sugarcreek Police Department	Tuscarawas	OH	5	1	200.00	1.08
Terrell County Sheriff's Office	Terrell	TX	5	1	200.00	101.63
Vergennes Police Department	Addison	VT	5	1	200.00	2.72
West Yellowstone Police Department	Gallatin	MT	5	1	200.00	1.12
Woodstock Police Department	Grafton	NH	5	1	200.00	1.12
Blue Lake Police Department	Humboldt	CA	4	1	250.00	0.74
Butler Township Police Department	Schuylkill	PA	4	1	250.00	0.67
Columbus Police Department	Luna	NM	4	1	250.00	3.98
Delhi Village Police Department	Delaware	NY	4	1	250.00	2.08
Elmore Police Department	Ottawa	OH	4	1	250.00	2.41
Fairland Police Department	Ottawa	OK	4	1	250.00	3.14
Foster Township Police Department	McKean	PA	4	1	250.00	2.30
Gold Beach Police Department	Curry	OR	4	1	250.00	4.47
Hemingway Police Department	Williamsburg	SC	4	1	250.00	2.91
Keokuk County Sheriff's Office	Keokuk	IA	4	1	250.00	9.51
Mahanoy City Borough Police Department	Schuylkill	PA	4	1	250.00	0.67
Malakoff Police Department	Henderson	TX	4	1	250.00	1.27
Marble Head Police Department	Ottawa	OH	4	1	250.00	2.41
Marshallville Police Dept.	Macon	GA	4	1	250.00	6.78
McArthur Police Department	Vinton	OH	4	1	250.00	7.44
Monroeville Police Department	Huron	OH	4	1	250.00	1.68
New Lisbon Police Department	Juneau	WI	4	1	250.00	3.75
Onley Police Department	Accomack	VA	4	1	250.00	3.02
Rochelle Police Department	Wilcox	GA	4	1	250.00	10.80
Roodhouse Police Dept	Greene	IL	4	1	250.00	7.20
Tutwiler Police Department	Tallahatchie	MS	4	1	250.00	6.50
Winsted Police Department	Litchfield	CT	4	1	250.00	0.53
Belle Police Department	Maries	MO	3	1	333.33	10.90
Bismarck Police Department	St. Francois	MO	3	1	333.33	1.53
Bowman Police Department	Orangeburg	SC	3	3	1000.00	3.24
Caddo Police Department	Bryan	OK	3	1	333.33	2.36
Carter County Sheriff's Office	Carter	MO	3	2	666.67	31.92
Earlville Police Dept	La Salle	IL	3	1	333.33	0.88
Fair Bluff Police Department	Columbus	NC	3	1	333.33	1.72

Freedom Police Department	Carroll	NH	3	1	333.33	2.09
Gallatin County Sheriff's Office	Gallatin	IL	3	1	333.33	17.89
Griggs County Sheriff's Office	Griggs	ND	3	1	333.33	41.32
Guadalupe County Sheriff's Office	Guadalupe	NM	3	1	333.33	21.34
Haskell Police Department	Haskell	TX	3	1	333.33	16.95
Hennessey Police Department	Kingfisher	OK	3	1	333.33	6.65
Kahoka Police Department	Clark	MO	3	1	333.33	6.58
Marvell Police Department	Phillips	AR	3	1	333.33	4.60
Meigs Police Department	Thomas	GA	3	1	333.33	2.24
Newbury Police Department	Merrimack	NH	3	1	333.33	0.68
Ravenna Police Dept	Buffalo	NE	3	1	333.33	2.17
Scotts Hill Police Department	Henderson	TN	3	1	333.33	3.60
Stover Police Department	Morgan	MO	3	1	333.33	4.86
Waukomis Police Department	Garfield	OK	3	1	333.33	1.65
Athena Police Department	Umatilla	OR	2	1	500.00	1.32
Birchwood Police Department	Washburn	WI	2	1	500.00	6.28
Boswell Police Department	Choctaw	OK	2	1	500.00	6.58
Cherokee Police Department	Alfalfa	OK	2	1	500.00	17.72
Franklin Police Dept	Franklin	NE	2	1	500.00	31.01
Hegins Township Police Department	Schuylkill	PA	2	1	500.00	0.67
Homer City Borough Police Department	Indiana	PA	2	1	500.00	1.13
Hunter Police Department	Greene	NY	2	1	500.00	2.03
Inman Police Department	McPherson	KS	2	1	500.00	3.43
Meyersdale Borough Police Department	Somerset	PA	2	1	500.00	1.29
Pineland Police Department	Sabine	TX	2	1	500.00	9.23
Pink Hill Police Department	Lenoir	NC	2	1	500.00	1.68
Ridgeville Police	Randolph	IN	2	1	500.00	3.82
Ridgeville Police Department	Dorchester	SC	2	1	500.00	2.57
Seadrift Police Department	Calhoun	TX	2	1	500.00	4.68
Springfield Police Department	Orangeburg	SC	2	1	500.00	1.08
White Cloud Police Department	Newaygo	MI	2	1	500.00	2.06
Windber Borough Police Department	Somerset	PA	2	1	500.00	1.29
Atwater Police Department	Kandiyohi	MN	1	1	1000.00	2.37
Berlin Borough Police Department	Somerset	PA	1	1	1000.00	1.29
Berlin Heights Police Department	Erie	OH	1	1	1000.00	1.30
Burr Oak Police Department	St. Joseph	MI	1	1	1000.00	1.63

Cooter Police Department	Pemiscot	MO	1	1	1000.00	5.47
Elgin Police Department	Grant	ND	1	1	1000.00	41.77
Hamburg Police Department	Fremont	IA	1	1	1000.00	13.44
Lamoure Police Department	LaMoure	ND	1	1	1000.00	24.16
Lockhart Police Department	Covington	AL	1	1	1000.00	2.65
Marion Township Police Department	Waushara	WI	1	1	1000.00	4.08
Mounds Police Dept	Pulaski	IL	1	2	2000.00	32.46
Nicholas County Sheriff's Office	Nicholas	KY	1	1	1000.00	14.02
Oakwood Police Department	Paulding	OH	1	1	1000.00	5.10
Perryville Police Department	Boyle	KY	1	1	1000.00	3.52
Petroleum County Sheriff's Office	Petroleum	MT	1	1	1000.00	202.43
Pineview Police Department	Wilcox	GA	1	1	1000.00	10.80
Tipton Police Department	Tillman	OK	1	1	1000.00	12.51
Turkey Creek Police Department	Evangeline	LA	1	1	1000.00	2.94
Wakeman Police Department	Huron	OH	1	1	1000.00	1.68
Wilson Police Department	Ellsworth	KS	1	1	1000.00	15.39
Zolfo Springs Police Department	Hardee	FL	1	1	1000.00	3.61
Bloomville Police Department	Seneca	OH	0	1		1.76
Dale County Sheriff's Office	Dale	AL	0	1		1.99
Errol Police Department	Coos	NH	0	1		3.03
New Athens Police Department	Harrison	OH	0	1		6.30
Port Jefferson Police Department	Shelby	OH	0	1		2.02
Wheeler Police Department	Dunn	WI	0	1		2.28

Appendix A-2. Primary State Police Agencies in Study: Rates of Officers Arrested, 2005-2011 (Sorted by # FT Sworn)

Agency	County	State	# of Full-Time Sworn Personnel	Per Agency	Per 1,000 Officers	Per 100,000 Population
California Highway Patrol	Sacramento	CA	7202	13	1.81	0.03
New York State Police	Albany	NY	4847	5	1.03	0.03
Pennsylvania State Police	Dauphin	PA	4458	26	5.83	0.20
Texas Department of Public Safety	Travis	TX	3529	6	1.70	0.02
New Jersey State Police	Mercer	NJ	3053	13	4.26	0.15
Massachusetts State Police	Middlesex	MA	2310	10	4.33	0.15
Illinois State Police	Sangamon	IL	2105	10	4.75	0.08
Virginia State Police	Chesterfield	VA	1873	3	1.60	0.04
North Carolina State Highway Patrol	Wake	NC	1827	8	4.38	0.08
Michigan State Police	Ingham	MI	1732	9	5.20	0.09
Florida Highway Patrol	Leon	FL	1606	14	8.72	0.07
Ohio State Highway Patrol	Franklin	OH	1560	4	2.56	0.03
Maryland State Police	Baltimore	MD	1440	9	6.25	0.16
Indiana State Police	Marion	IN	1315	4	3.04	0.06
Arizona Department of Public Safety	Maricopa	AZ	1244	3	2.41	0.05
Connecticut State Police	Middlesex	CT	1227	4	3.26	0.11
Louisiana State Police	East Baton Rouge	LA	1215	2	1.65	0.04
Washington State Patrol	Thurston	WA	1132	2	1.77	0.03
Georgia Department of Public Safety	Fulton	GA	1048	1	0.95	0.01
South Carolina Highway Patrol	Richland	SC	967	10	10.34	0.22
Tennessee Department of Safety	Davidson	TN	942	4	4.25	0.06
Kentucky State Police	Franklin	KY	882	3	3.40	0.07
Oklahoma Department of Public Safety	Oklahoma	OK	825	5	6.06	0.13
Alabama Department of Public Safety	Montgomery	AL	763	2	2.62	0.04
Colorado State Patrol	Jefferson	CO	742	4	5.39	0.08
Iowa Department of Public Safety	Polk	IA	669	2	2.99	0.07
Delaware State Police	Kent	DE	658	3	4.56	0.33
Mississippi Highway Safety Patrol	Hinds	MS	594	6	10.10	0.20
Minnesota State Patrol	Ramsey	MN	530	4	7.55	0.08
New Mexico State Police	Santa Fe	NM	528	13	24.62	0.63
Arkansas State Police	Pulaski	AR	525	2	3.81	0.07

Nebraska State Patrol	Lancaster	NE	491	1	2.04	0.05
Utah Department of Public Safety	Salt Lake	UT	475	2	4.21	0.07
Nevada Highway Patrol	Carson	NV	417	3	7.19	0.11
New Hampshire State Police	Merrimack	NH	350	3	8.57	0.23
Maine State Police	Kennebec	ME	334	1	2.99	0.08
Vermont State Police	Washington	VT	307	1	3.26	0.16
Alaska State Troopers	Anchorage	AK	274	1	3.65	0.14
Idaho State Police	Ada	ID	264	1	3.79	0.06
Wyoming Highway Patrol	Laramie	WY	204	1	4.90	0.18
Rhode Island State Police	Providence	RI	201	2	9.95	0.19
Arkansas Highway Police	Pulaski	AR	149	2	13.42	0.07

Appendix A-3. Sheriff's Offices in Study: Rates of Officers Arrested, 2005-2011 (Sorted by # FT Sworn)

Agency	County	State	# of Full-Time Sworn Personnel	Per Agency	Per 1,000 Officers	Per 100,000 Population
Los Angeles County Sheriff's Office	Los Angeles	CA	9461	14	1.48	0.14
Cook County Sheriff's Office	Cook	IL	5655	8	1.41	0.15
Harris County Sheriff's Office	Harris	TX	2558	3	1.17	0.07
Riverside County Sheriff's Office	Riverside	CA	2147	11	5.12	0.50
San Bernardino County Sheriff's Office	San Bernardino	CA	1797	11	6.12	0.54
Orange County Sheriff-Coroner Department	Orange	CA	1794	14	7.80	0.47
Broward County Sheriff's Office	Broward	FL	1624	16	9.85	0.92
Palm Beach County Sheriff's Office	Palm Beach	FL	1447	12	8.29	0.91
Sacramento County Sheriff's Office	Sacramento	CA	1409	6	4.26	0.42
Orange County Sheriff's Office	Orange	FL	1398	16	11.44	1.40
San Diego County Sheriff's Office	San Diego	CA	1322	7	5.30	0.23
Hillsborough County Sheriff's Office	Hillsborough	FL	1223	10	8.18	0.81
Wayne County Sheriff's Office	Wayne	MI	1062	1	0.94	0.05
Alameda County Sheriff's Office	Alameda	CA	928	2	2.16	0.13
Pinellas County Sheriff's Office	Pinellas	FL	863	8	9.27	0.87
Jefferson Parish Sheriff's Office	Jefferson	LA	825	12	14.55	2.77
Maricopa County Sheriff's Office	Maricopa	AZ	766	2	2.61	0.05
Ventura County Sheriff's Office	Ventura	CA	755	1	1.32	0.12
Marion County Sheriff's Office	Marion	IN	740	7	9.46	0.77
Denver County Sheriff's Office	Denver	CO	739	5	6.77	0.83
King County Sheriff's Office	King	WA	721	5	6.93	0.26
Contra Costa County Sheriff's Office	Contra Costa	CA	679	1	1.47	0.10
Collier County Sheriff's Office	Collier	FL	628	6	9.55	1.87
Lee County Sheriff's Office	Lee	FL	621	7	11.27	1.13
Polk County Sheriff's Office	Polk	FL	600	13	21.67	2.16
Calcasieu Parish Sheriff's Office	Calcasieu	LA	592	1	1.69	0.52
Pima County Sheriff's Dept.	Pima	AZ	554	1	1.81	0.10
Gwinnett County Sheriff's Office	Gwinnett	GA	531	3	5.65	0.37
Passaic County Sheriff's Office	Passaic	NJ	530	6	11.32	1.20
Bexar County Sheriff's Office	Bexar	TX	526	5	9.51	0.29
Milwaukee County Sheriff's Office	Milwaukee	WI	524	7	13.36	0.74
Fulton County Sheriff's Office	Fulton	GA	516	4	7.75	0.43

Shelby County Sheriff's Office	Shelby	TN	516	8	15.50	0.86
Tulare County Sheriff's Office	Tulare	CA	513	3	5.85	0.68
Kern County Sheriff's Office	Kern	CA	512	11	21.48	1.31
Richland County Sheriff's Office	Richland	SC	512	3	5.86	0.78
Orleans Parish Sheriff's Office (Criminal Division)	Orleans	LA	505	4	7.92	1.16
Fairfax County Sheriff's Office	Fairfax	VA	499	3	6.01	0.28
Brevard County Sheriff's Office	Brevard	FL	497	2	4.02	0.37
Monmouth County Sheriff's Office	Monmouth	NJ	494	1	2.02	0.16
Pasco County Sheriff's Office	Pasco	FL	485	4	8.25	0.86
Manatee County Sheriff's Office	Manatee	FL	476	4	8.40	1.24
Fresno County Sheriff's Office	Fresno	CA	461	1	2.17	0.11
Knox County Sheriff's Office	Knox	TN	456	1	2.19	0.23
Franklin County Sheriff's Office	Franklin	OH	455	2	4.40	0.17
Dane County Sheriff's Office	Dane	WI	454	2	4.41	0.41
El Paso County Sheriff's Office	El Paso	CO	454	1	2.20	0.16
Santa Clara County Sheriff's Office	Santa Clara	CA	450	1	2.22	0.06
Volusia County Sheriff's Office	Volusia	FL	450	4	8.89	0.81
Dallas County Sheriff's Office	Dallas	TX	449	1	2.23	0.04
Richmond County Sheriff's Office	Richmond	GA	449	5	11.14	2.49
Loudoun County Sheriff's Office	Loudoun	VA	448	2	4.46	0.64
Will County Sheriff's Office	Will	IL	445	1	2.25	0.15
Leon County Sheriff's Office	Leon	FL	443	3	6.77	1.09
Cobb County Sheriff's Office	Cobb	GA	435	1	2.30	0.15
Ouachita Parish Sheriff's Office	Ouachita	LA	431	1	2.32	0.65
Richmond (City) Sheriff's Office	Richmond City	VA	424	2	4.72	0.98
Martin County Sheriff's Office	Martin	FL	414	1	2.42	0.68
Norfolk (City) Sheriff's Office	Norfolk City	VA	414	1	2.42	0.41
Washoe County Sheriff's Office	Washoe	NV	414	4	9.66	0.95
Sarasota County Sheriff's Office	Sarasota	FL	409	1	2.44	0.26
St. Tammany Parish Sheriff's Office	St. Tammany	LA	409	2	4.89	0.86
Arapahoe County Sheriff's Office	Arapahoe	CO	407	2	4.91	0.35
Greenville County Sheriff's Office	Greenville	SC	397	2	5.04	0.44
Summit County Sheriff's Office	Summit	OH	393	1	2.54	0.18
Escambia County Sheriff's Office	Escambia	FL	388	3	7.73	1.01
Osceola County Sheriff's Office	Osceola	FL	388	2	5.15	0.74
Adams County Sheriff's Office	Adams	CO	364	2	5.49	0.45

East Baton Rouge Parish Sheriff's Office	East Baton Rouge	LA	359	3	8.36	0.68
Chesapeake (City) Sheriff's Office	Chesapeake City	VA	358	2	5.59	0.90
Seminole County Sheriff's Office	Seminole	FL	355	2	5.63	0.47
Wake County Sheriff's Office	Wake	NC	354	4	11.30	0.44
Marion County Sheriff's Office	Marion	FL	349	3	8.60	0.91
Hamilton County Sheriff's Office	Hamilton	OH	330	1	3.03	0.12
DeKalb County Sheriff's Office	DeKalb	GA	325	2	6.15	0.29
Clackamas County Sheriff's Office	Clackamas	OR	319	2	6.27	0.53
New Hanover County Sheriff's Office	New Hanover	NC	315	3	9.52	1.48
Bossier Parish Sheriff's Office	Bossier	LA	300	3	10.00	2.56
Terrebonne Parish Sheriff's Office	Terrebonne	LA	300	2	6.67	1.79
Spartanburg County Sheriff's Office	Spartanburg	SC	297	2	6.73	0.70
Santa Barbara County Sheriff's Office	Santa Barbara	CA	294	1	3.40	0.24
Pierce County Sheriff's Office	Pierce	WA	292	2	6.85	0.25
St. Charles Parish Sheriff's Office	St. Charles	LA	291	1	3.44	1.89
Bibb County Sheriff's Office	Bibb	GA	290	3	10.34	1.93
Lucas County Sheriff's Office	Lucas	OH	289	4	13.84	0.91
Lafourche Parish Sheriff's Office	Lafourche	LA	287	3	10.45	3.11
Montgomery County Sheriff's Office	Montgomery	TN	287	1	3.48	0.58
Snohomish County Sheriff's Office	Snohomish	WA	287	2	6.97	0.28
Lake County Sheriff's Office	Lake	FL	286	3	10.49	1.01
Charlotte County Sheriff's Office	Charlotte	FL	285	3	10.53	1.88
Clay County Sheriff's Office	Clay	FL	284	3	10.56	1.57
Harford County Sheriff's Office	Harford	MD	280	1	3.57	0.41
Bernalillo County Sheriff's Office	Bernalillo	NM	279	3	10.75	0.45
Alachua County Sheriff's Office	Alachua	FL	276	1	3.62	0.40
Monroe County Sheriff's Office	Monroe	NY	273	3	10.99	0.40
Hidalgo County Sheriff's Office	Hidalgo	TX	262	5	19.08	0.65
Morris County Sheriff's Office	Morris	NJ	262	1	3.82	0.20
Charleston County Sheriff's Office	Charleston	SC	259	4	15.44	1.14
St. Lucie County Sheriff's Office	St. Lucie	FL	259	2	7.72	0.72
Okaloosa County Sheriff's Office	Okaloosa	FL	258	3	11.63	1.66
Hall County Sheriff's Office	Hall	GA	257	2	7.78	1.11
Marion County Sheriff's Office	Marion	OR	255	1	3.92	0.32
Barnstable County Sheriff's Office	Barnstable	MA	254	5	19.69	2.32
Forsyth County Sheriff's Office	Forsyth	GA	253	5	19.76	2.85

Hernando County Sheriff's Office	Hernando	FL	249	1	4.02	0.58
El Paso County Sheriff's Office	El Paso	TX	248	2	8.06	0.25
Macomb County Sheriff's Office	Macomb	MI	245	1	4.08	0.12
Spokane County Sheriff's Office	Spokane	WA	244	2	8.20	0.42
Iberia Parish Sheriff's Office	Iberia	LA	242	6	24.79	8.19
Onondaga County Sheriff's Office	Onondaga	NY	242	1	4.13	0.21
Galveston County Sheriff's Office	Galveston	TX	240	1	4.17	0.34
Ramsey County Sheriff's Office	Ramsey	MN	235	2	8.51	0.39
Prince George's County Sheriff's Office	Prince Georges	MD	233	3	12.88	0.35
Stanislaus County Sheriff's Office	Stanislaus	CA	230	1	4.35	0.19
Placer County Sheriff's Office	Placer	CA	228	1	4.39	0.29
Indian River County Sheriff's Office	Indian River	FL	226	3	13.27	2.17
Chesterfield County Sheriff's Office	Chesterfield	VA	225	1	4.44	0.32
Montgomery County Sheriff's Office	Montgomery	OH	222	1	4.50	0.19
Hudson County Sheriff's Office	Hudson	NJ	221	3	13.57	0.47
Pinal County Sheriff's Office	Pinal	AZ	218	2	9.17	0.53
Forsyth County Sheriff's Office	Forsyth	NC	217	2	9.22	0.57
Bay County Sheriff's Office	Bay	FL	213	2	9.39	1.18
Rapides Parish Sheriff's Office	Rapides	LA	212	1	4.72	0.76
Beaufort County Sheriff's Office	Beaufort	SC	209	1	4.78	0.62
Columbia County Sheriff's Office	Columbia	GA	206	2	9.71	1.61
Williamson County Sheriff's Office	Williamson	TX	206	2	9.71	0.47
Marin County Sheriff's Office	Marin	CA	202	1	4.95	0.40
Wilson County Sheriff's Office	Wilson	TN	202	1	4.95	0.88
St. Louis County Sheriff's Office	St. Louis	MO	200	4	20.00	0.40
Anderson County Sheriff's Office	Anderson	SC	191	2	10.47	1.07
Santa Rosa County Sheriff's Office	Santa Rosa	FL	190	1	5.26	0.66
Monroe County Sheriff's Office	Monroe	FL	189	3	15.87	4.10
Rutherford County Sheriff's Office	Rutherford	TN	189	2	10.58	0.76
St. Bernard Parish Sheriff's Office	St. Bernard	LA	189	1	5.29	2.79
Lake County Sheriff's Office	Lake	IL	188	1	5.32	0.14
Sullivan County Sheriff's Office	Sullivan	TN	183	1	5.46	0.64
Frederick County Sheriff's Office	Frederick	MD	177	1	5.65	0.43
Paulding County Sheriff's Office	Paulding	GA	175	1	5.71	0.70
Boulder County Sheriff's Office	Boulder	CO	174	1	5.75	0.34
Lake County Sheriff's Office	Lake	IN	170	5	29.41	1.01

Middlesex County Sheriff's Department	Middlesex	NJ	170	4	23.53	0.49
Union County Sheriff's Office	Union	NC	170	1	5.88	0.50
Walton County Sheriff's Office	Walton	FL	165	4	24.24	7.27
Salem County Sheriff's Office	Salem	NJ	157	1	6.37	1.51
San Luis Obispo County Sheriff's Office	San Luis Obispo	CA	156	2	12.82	0.74
St. Charles County Sheriff's Office	St. Charles	MO	153	2	13.07	0.55
Newton County Sheriff's Office	Newton	GA	152	1	6.58	1.00
Allegheny County Sheriff's Office	Allegheny	PA	151	3	19.87	0.25
St. John The Baptist Parish Sheriff's Office	St. John the Baptist	LA	150	3	20.00	6.53
Waukesha County Sheriff's Office	Waukesha	WI	150	1	6.67	0.26
Hamilton County Sheriff's Office	Hamilton	TN	146	2	13.70	0.59
Lowndes County Sheriff's Office	Lowndes	GA	145	1	6.90	0.92
Plaquemines Parish Sheriff's Office	Plaquemines	LA	145	1	6.90	4.34
Polk County Sheriff's Office	Polk	IA	143	3	20.98	0.70
Winnebago County Sheriff's Office	Winnebago	IL	142	1	7.04	0.34
Cuyahoga County Sheriff's Office	Cuyahoga	OH	141	3	21.28	0.23
Coweta County Sheriff's Office	Coweta	GA	137	1	7.30	0.79
Clark County Sheriff's Office	Clark	OH	134	1	7.46	0.72
McHenry County Sheriff's Office	McHenry	IL	134	2	14.93	0.65
Anoka County Sheriff's Office	Anoka	MN	133	1	7.52	0.30
Washtenaw County Sheriff's Office	Washtenaw	MI	133	4	30.08	1.16
Boone County Sheriff's Office	Boone	KY	130	1	7.69	0.84
Flagler County Sheriff's Office	Flagler	FL	130	2	15.38	2.09
Highlands County Sheriff's Office	Highlands	FL	130	1	7.69	1.01
Robeson County Sheriff's Office	Robeson	NC	128	3	23.44	2.24
Barrow County Sheriff's Office	Barrow	GA	127	1	7.87	1.44
Brazoria County Sheriff's Office	Brazoria	TX	127	1	7.87	0.32
Catawba County Sheriff's Office	Catawba	NC	126	1	7.94	0.65
Livingston Parish Sheriff's Office	Livingston	LA	125	1	8.00	0.78
Pitt County Sheriff's Office	Pitt	NC	125	3	24.00	1.78
Kenosha County Sheriff's Office	Kenosha	WI	122	1	8.20	0.60
Kitsap County Sheriff's Office	Kitsap	WA	121	1	8.26	0.40
Weld County Sheriff's Office	Weld	CO	121	1	8.26	0.40
New York City Sheriff's Office	New York	NY	120	2	16.67	2.44
St. Mary's County Sheriff's Office	St. Marys	MD	120	1	8.33	0.95
Sauk County Sheriff's Office	Sauk	WI	118	1	8.47	1.61

St. Joseph County Sheriff's Office	St. Joseph	IN	116	3	25.86	1.12
Clay County Sheriff's Office	Clay	MO	115	1	8.70	0.45
Orange County Sheriff's Office	Orange	NC	115	1	8.70	0.75
Whitfield County Sheriff's Office	Whitfield	GA	115	1	8.70	0.97
Brunswick County Sheriff's Office	Brunswick	NC	114	2	17.54	1.86
Solano County Sheriff's Office	Solano	CA	113	1	8.85	0.24
Henry County Sheriff's Office	Henry	VA	112	14	125.00	25.85
Butte County Sheriff's Office	Butte	CA	110	1	9.09	0.45
Niagara County Sheriff's Office	Niagara	NY	110	1	9.09	0.46
Nassau County Sheriff's Office	Nassau	FL	109	2	18.35	2.73
Nye County Sheriff's Office	Nye	NV	108	3	27.78	6.83
Cameron County Sheriff's Office	Cameron	TX	107	2	18.69	0.49
Madison County Sheriff's Office	Madison	AL	107	1	9.35	0.30
Acadia Parish Sheriff's Office	Acadia	LA	105	1	9.52	1.62
Sutter County Sheriff's Office	Sutter	CA	105	1	9.52	1.06
Atlantic County Sheriff's Office	Atlantic	NJ	103	1	9.71	0.36
Benton County Sheriff's Office	Benton	AR	103	1	9.71	0.45
Douglas County Sheriff's Office	Douglas	NV	100	1	10.00	2.13
Baltimore (City) Sheriff's Office	Baltimore City	MD	99	2	20.20	0.32
Orange County Sheriff's Office	Orange	NY	99	1	10.10	0.27
Williamson County Sheriff's Office	Williamson	TN	99	2	20.20	1.09
Lincoln County Sheriff's Office	Lincoln	NC	98	4	40.82	5.11
Johnston County Sheriff's Office	Johnston	NC	97	1	10.31	0.59
Rock County Sheriff's Office	Rock	WI	94	2	21.28	1.25
San Juan County Sheriff's Office	San Juan	NM	94	2	21.28	1.54
Washington County Sheriff's Office	Washington	MD	94	1	10.64	0.68
Lancaster County Sheriff's Office	Lancaster	SC	93	1	10.75	1.30
Potter County Sheriff's Office	Potter	TX	93	2	21.51	1.65
Kane County Sheriff's Office	Kane	IL	92	1	10.87	0.19
Orangeburg County Sheriff's Office	Orangeburg	SC	92	1	10.87	1.08
Harrison County Sheriff's Office	Harrison	MS	90	1	11.11	0.53
Smith County Sheriff's Office	Smith	TX	88	1	11.36	0.48
Carver County Sheriff's Office	Carver	MN	87	1	11.49	1.10
Burke County Sheriff's Office	Burke	NC	86	1	11.63	1.10
Delaware County Sheriff's Office	Delaware	OH	86	1	11.63	0.57
Washington County Sheriff's Office	Washington	TN	86	1	11.63	0.81

Wayne County Sheriff's Office	Wayne	NC	85	2	23.53	1.63
Baltimore County Sheriff's Office	Baltimore	MD	84	1	11.90	0.12
Ozaukee County Sheriff's Office	Ozaukee	WI	83	1	12.05	1.16
Walker County Sheriff's Office	Walker	GA	80	2	25.00	2.91
Cullman County Sheriff's Office	Cullman	AL	78	1	12.82	1.24
Franklin County Sheriff's Office	Franklin	VA	78	1	12.82	1.78
Madera County Sheriff's Office	Madera	CA	78	1	12.82	0.66
Bedford County Sheriff's Office	Bedford	VA	77	2	25.97	2.91
Dakota County Sheriff's Office	Dakota	MN	77	1	12.99	0.25
Eaton County Sheriff's Office	Eaton	MI	77	1	12.99	0.93
Prince William County Sheriff's Office	Prince William	VA	75	1	13.33	0.25
Santa Fe County Sheriff's Office	Santa Fe	NM	75	1	13.33	0.69
Outagamie County Sheriff's Office	Outagamie	WI	74	1	13.51	0.57
Saginaw County Sheriff's Office	Saginaw	MI	71	1	14.08	0.50
Cleveland County Sheriff's Office	Cleveland	OK	70	1	14.29	0.39
Minnehaha County Sheriff's Office	Minnehaha	SD	69	1	14.49	0.59
Yakima County Sheriff's Office	Yakima	WA	69	2	28.99	0.82
Hendry County Sheriff's Office	Hendry	FL	67	1	14.93	2.55
Marathon County Sheriff's Office	Marathon	WI	67	1	14.93	0.75
Portage County Sheriff's Office	Portage	OH	66	1	15.15	0.62
Laurens County Sheriff's Office	Laurens	SC	65	1	15.38	1.50
Lincoln County Sheriff's Office	Lincoln	OR	65	1	15.38	2.17
Livingston County Sheriff's Office	Livingston	MI	65	2	30.77	1.11
Pennington County Sheriff's Office	Pennington	SD	65	1	15.38	0.99
Darlington County Sheriff's Office	Darlington	SC	64	1	15.63	1.46
Grand Traverse County Sheriff's Office	Grand Traverse	MI	64	2	31.25	2.30
Hamilton County Sheriff's Office	Hamilton	IN	64	1	15.63	0.36
Vernon Parish Sheriff's Office	Vernon	LA	64	2	31.25	3.82
Jackson County Sheriff's Office	Jackson	FL	61	1	16.39	2.01
Kershaw County Sheriff's Office	Kershaw	SC	61	1	16.39	1.62
Lake County Sheriff's Office	Lake	CA	61	2	32.79	3.09
Porter County Sheriff's Office	Porter	IN	61	2	32.79	1.22
Allegan County Sheriff's Office	Allegan	MI	59	1	16.95	0.90
Campbell County Sheriff's Office	Campbell	WY	58	1	17.24	2.17
Delaware County Sheriff's Office	Delaware	PA	58	2	34.48	0.36
La Porte County Sheriff's Office	La Porte	IN	58	1	17.24	0.90

Lenoir County Sheriff's Office	Lenoir	NC	58	2	34.48	3.36
Putnam County Sheriff's Office	Putnam	TN	58	2	34.48	2.77
Elko County Sheriff's Office	Elko	NV	57	1	17.54	2.05
Pender County Sheriff's Office	Pender	NC	57	1	17.54	1.92
Ulster County Sheriff's Office	Ulster	NY	57	1	17.54	0.55
Horry County Sheriff's Office	Horry	SC	55	1	18.18	0.37
Morgan County Sheriff's Office	Morgan	AL	55	1	18.18	0.84
Yellowstone County Sheriff's Office	Yellowstone	MT	55	1	18.18	0.68
Assumption Parish Sheriff's Office	Assumption	LA	50	2	40.00	8.54
Bucks County Sheriff's Office	Bucks	PA	50	2	40.00	0.32
Hoke County Sheriff's Office	Hoke	NC	50	1	20.00	2.13
Pottawattamie County Sheriff's Office	Pottawattomie	IA	50	1	20.00	1.07
Queen Anne's County Sheriff's Office	Queen Annes	MD	50	1	20.00	2.09
Caroline County Sheriff's Office	Caroline	VA	49	3	61.22	10.51
Page County Sheriff's Office	Page	VA	49	1	20.41	4.16
Stanly County Sheriff's Office	Stanly	NC	49	1	20.41	1.65
Cherokee County Sheriff's Office	Cherokee	SC	48	2	41.67	3.61
Lee County Sheriff's Office	Lee	NC	47	1	21.28	1.73
Thomas County Sheriff's Office	Thomas	GA	47	2	42.55	4.47
Lincoln Parish Sheriff's Office	Lincoln	LA	46	1	21.74	2.14
Rockingham County Sheriff's Office	Rockingham	VA	46	1	21.74	1.31
Davie County Sheriff's Office	Davie	NC	45	3	66.67	7.27
Grant County Sheriff's Office	Grant	IN	45	1	22.22	1.43
Harrison County Sheriff's Office	Harrison	TX	45	1	22.22	1.52
Juneau County Sheriff's Office	Juneau	WI	45	1	22.22	3.75
Sandoval County Sheriff's Office	Sandoval	NM	45	1	22.22	0.76
St. Martin Parish Sheriff's Office	St. Martin	LA	45	1	22.22	1.92
Upshur County Sheriff's Office	Upshur	TX	45	1	22.22	2.54
Chambers County Sheriff's Office	Chambers	TX	44	1	22.73	2.85
Lenawee County Sheriff's Office	Lenawee	MI	44	1	22.73	1.00
Saline County Sheriff's Office	Saline	KS	44	1	22.73	1.80
St. Croix County Sheriff's Office	St. Croix	WI	44	1	22.73	1.19
Sullivan County Sheriff's Office	Sullivan	NY	44	1	22.73	1.29
Zapata County Sheriff's Office	Zapata	TX	44	1	22.73	7.13
La Crosse County Sheriff's Office	La Crosse	WI	43	1	23.26	0.87
Hawkins County Sheriff's Office	Hawkins	TN	42	1	23.81	1.76

Saline County Sheriff's Office	Saline	IL	42	1	23.81	4.01
Chesterfield County Sheriff's Office	Chesterfield	SC	41	1	24.39	2.14
Columbia County Sheriff's Office	Columbia	OR	41	1	24.39	2.03
Bullitt County Sheriff's Office	Bullitt	KY	40	1	25.00	1.35
Burleigh County Sheriff's Office	Burleigh	ND	40	2	50.00	2.46
Hancock County Sheriff's Office	Hancock	IN	40	3	75.00	4.29
Isle of Wight County Sheriff's Office	Isle of Wight	VA	40	1	25.00	2.84
McDowell County Sheriff's Office	McDowell	NC	40	1	25.00	2.22
White County Sheriff's Office	White	GA	40	1	25.00	3.68
Wood County Sheriff's Office	Wood	WV	40	1	25.00	1.15
Luzerne County Sheriff's Office	Luzerne	PA	38	2	52.63	0.62
Vigo County Sheriff's Office	Vigo	IN	38	1	26.32	0.93
Liberty County Sheriff's Office	Liberty	TX	37	2	54.05	2.64
Muskogee County Sheriff's Office	Muskogee	OK	37	1	27.03	1.41
Valencia County Sheriff's Office	Valencia	NM	37	1	27.03	1.31
Woodford County Sheriff's Office	Woodford	IL	37	1	27.03	2.59
Dauphin County Sheriff's Office	Dauphin	PA	36	2	55.56	0.75
La Salle County Sheriff's Office	La Salle	IL	36	1	27.78	0.88
Yamhill County Sheriff's Office	Yamhill	OR	36	1	27.78	1.01
Clark County Sheriff's Office	Clark	IN	35	1	28.57	0.91
McKinley County Sheriff's Office	McKinley	NM	35	1	28.57	1.40
DeKalb County Sheriff's Office	DeKalb	AL	34	1	29.41	1.41
Madison County Sheriff's Office	Madison	GA	34	1	29.41	3.56
Martin County Sheriff's Office	Martin	NC	34	1	29.41	4.08
Holmes County Sheriff's Office	Holmes	OH	33	1	30.30	2.36
Baxter County Sheriff's Office	Baxter	AR	32	1	31.25	2.41
Russell County Sheriff's Office	Russell	AL	32	2	62.50	3.78
Starr County Sheriff's Office	Starr	TX	31	1	32.26	1.64
Stephens County Sheriff's Office	Stephens	GA	31	1	32.26	3.82
Clay County Sheriff's Office	Clay	IN	30	1	33.33	3.72
Del Norte County Sheriff's Office	Del Norte	CA	30	2	66.67	6.99
Greenbrier County Sheriff's Office	Greenbrier	WV	30	1	33.33	2.82
Luna County Sheriff's Office	Luna	NM	30	1	33.33	3.98
Okanogan County Sheriff's Office	Okanogan	WA	30	1	33.33	2.43
Otero County Sheriff's Office	Otero	NM	30	1	33.33	1.57
Shelby County Sheriff's Office	Shelby	OH	30	1	33.33	2.02

Warren County Sheriff's Office	Warren	NC	30	1	33.33	4.77
Dearborn County Sheriff's Office	Dearborn	IN	29	2	68.97	4.00
Halifax County Sheriff's Office	Halifax	VA	29	1	34.48	2.76
Orleans County Sheriff's Office	Orleans	NY	29	1	34.48	2.33
Ravalli County Sheriff's Office	Ravalli	MT	29	1	34.48	2.49
San Benito County Sheriff's Office	San Benito	CA	29	1	34.48	1.81
Williamson County Sheriff's Office	Williamson	IL	29	2	68.97	3.01
Lee County Sheriff's Office	Lee	SC	28	1	35.71	5.20
White County Sheriff's Office	White	TN	28	1	35.71	3.87
Accomack County Sheriff's Office	Accomack	VA	27	1	37.04	3.02
Crawford County Sheriff's Office	Crawford	AR	27	1	37.04	1.61
Jim Wells County Sheriff's Office	Jim Wells	TX	27	1	37.04	2.45
Marion County Sheriff's Office	Marion	WV	27	1	37.04	1.77
Polk County Sheriff's Office	Polk	GA	27	2	74.07	4.82
Emery County Sheriff's Office	Emery	UT	26	2	76.92	18.22
Hampton County Sheriff's Office	Hampton	SC	26	1	38.46	4.74
Morgan County Sheriff's Office	Morgan	IN	26	2	76.92	2.90
Steuben County Sheriff's Office	Steuben	NY	26	1	38.46	1.01
Dade County Sheriff's Office	Dade	GA	25	1	40.00	0.04
Lawrence County Sheriff's Office	Lawrence	IN	25	1	40.00	2.17
Marlboro County Sheriff's Office	Marlboro	SC	25	2	80.00	6.91
Newaygo County Sheriff's Office	Newaygo	MI	25	1	40.00	2.06
Nez Perce County Sheriff's Office	Nez Perce	ID	25	2	80.00	5.09
Tuscola County Sheriff's Office	Tuscola	MI	25	1	40.00	1.79
Dallas County Sheriff's Office	Dallas	IA	23	2	86.96	3.02
Emmet County Sheriff's Office	Emmet	MI	23	1	43.48	3.06
Graham County Sheriff's Office	Graham	AZ	23	1	43.48	2.69
Monroe County Sheriff's Office	Monroe	WI	23	1	43.48	2.24
Seneca County Sheriff's Office	Seneca	NY	23	6	260.87	17.02
Winn Parish Sheriff's Office	Winn	LA	23	1	43.48	6.53
Columbiana County Sheriff's Office	Columbiana	OH	22	2	90.91	1.85
Fayette County Sheriff's Office	Fayette	OH	22	3	136.36	10.33
Hardeman County Sheriff's Office	Hardeman	TN	22	1	45.45	3.67
Harrison County Sheriff's Office	Harrison	IN	22	1	45.45	2.54
Haywood County Sheriff's Office	Haywood	TN	22	1	45.45	5.32
Rio Arriba County Sheriff's Office	Rio Arriba	NM	22	1	45.45	2.48

Routt County Sheriff's Office	Routt	CO	22	1	45.45	4.25
St. Helena Parish Sheriff's Office	St. Helena	LA	22	1	45.45	8.93
Mason County Sheriff's Office	Mason	WV	21	3	142.86	10.98
San Jacinto County Sheriff's Office	San Jacinto	TX	21	1	47.62	3.79
Daviess County Sheriff's Office	Daviess	IN	19	1	52.63	3.16
Oglethorpe County Sheriff's Office	Oglethorpe	GA	19	1	52.63	6.71
Pawnee County Sheriff's Office	Pawnee	OK	19	1	52.63	6.03
Bolivar County Sheriff's Office	Bolivar	MS	18	1	55.56	2.93
Calhoun County Sheriff's Office	Calhoun	FL	18	1	55.56	6.84
Clarke County Sheriff's Office	Clarke	VA	18	1	55.56	7.13
Duval County Sheriff's Office	Duval	TX	18	1	55.56	8.49
Osceola County Sheriff's Office	Osceola	MI	18	1	55.56	4.25
Towns County Sheriff's Office	Towns	GA	18	1	55.56	9.55
Centre County Sheriff's Office	Centre	PA	17	1	58.82	0.65
Cross County Sheriff's Office	Cross	AR	17	1	58.82	5.60
Hunterdon County Sheriff's Office	Hunterdon	NJ	17	1	58.82	0.78
Lincoln County Sheriff's Office	Lincoln	SD	17	1	58.82	2.23
McIntosh County Sheriff's Office	McIntosh	OK	17	2	117.65	9.88
Middlesex County Sheriff's Office	Middlesex	VA	17	1	58.82	9.12
Dewitt County Sheriff's Office	De Witt	IL	16	1	62.50	6.04
Miller County Sheriff's Office	Miller	MO	16	1	62.50	4.04
Phillips County Sheriff's Office	Phillips	AR	16	1	62.50	4.60
Greene County Sheriff's Office	Greene	AR	15	1	66.67	2.38
Jackson County Sheriff's Office	Jackson	KS	15	1	66.67	7.43
Long County Sheriff's Office	Long	GA	15	1	66.67	6.91
McDowell County Sheriff's Office	McDowell	WV	15	1	66.67	4.52
Jackson County Sheriff's Office	Jackson	TN	14	3	214.29	25.78
Lowndes County Sheriff's Office	Lowndes	AL	14	1	71.43	8.85
Morrow County Sheriff's Office	Morrow	OR	14	1	71.43	8.95
Benzie County Sheriff's Office	Benzie	MI	13	1	76.92	5.71
Hempstead County Sheriff's Office	Hempstead	AR	13	1	76.92	4.42
Randolph County Sheriff's Office	Randolph	IL	13	1	76.92	2.99
Bibb County Sheriff's Office	Bibb	AL	12	1	83.33	4.36
Clayton County Sheriff's Office	Clayton	IA	12	1	83.33	5.52
Custer County Sheriff's Office	Custer	OK	12	1	83.33	3.64
Franklin County Sheriff's Office	Franklin	IN	12	1	83.33	4.33

Gage County Sheriff's Office	Gage	NE	12	1	83.33	4.48
Lincoln County Sheriff's Office	Lincoln	GA	12	1	83.33	12.51
Perry County Sheriff's Office	Perry	IL	12	1	83.33	4.47
Whitley County Sheriff's Office	Whitley	KY	12	1	83.33	2.81
Floyd County Sheriff's Office	Floyd	IA	11	1	90.91	6.13
Greene County Sheriff's Office	Greene	AL	11	1	90.91	11.06
Hockley County Sheriff's Office	Hockley	TX	11	2	181.82	8.72
Pulaski County Sheriff's Office	Pulaski	IL	11	2	181.82	32.46
Roosevelt County Sheriff's Office	Roosevelt	MT	11	1	90.91	9.59
Simpson County Sheriff's Office	Simpson	KY	11	1	90.91	5.77
Stark County Sheriff's Office	Stark	ND	11	1	90.91	4.13
Stephens County Sheriff's Office	Stephens	OK	11	2	181.82	4.44
Ferry County Sheriff's Office	Ferry	WA	10	1	100.00	13.24
La Salle County Sheriff's Office	La Salle	TX	10	3	300.00	43.57
Montague County Sheriff's Office	Montague	TX	10	1	100.00	5.07
Powell County Sheriff's Office	Powell	MT	10	1	100.00	14.23
Socorro County Sheriff's Office	Socorro	NM	10	1	100.00	5.60
Winkler County Sheriff's Office	Winkler	TX	10	1	100.00	14.06
Butler County Sheriff's Office	Butler	AL	9	3	333.33	14.32
Lake County Sheriff's Office	Lake	CO	9	2	222.22	27.36
Big Horn County Sheriff's Office	Big Horn	MT	8	1	125.00	7.77
Blackford County Sheriff's Office	Blackford	IN	8	1	125.00	7.83
Henry County Sheriff's Office	Henry	AL	8	1	125.00	5.78
Kingfisher County Sheriff's Office	Kingfisher	OK	8	1	125.00	6.65
Madison County Sheriff's Office	Madison	MO	8	1	125.00	8.18
Talbot County Sheriff's Office	Talbot	GA	8	3	375.00	43.70
Clay County Sheriff's Office	Clay	AR	7	1	142.86	6.22
Fremont County Sheriff's Office	Fremont	IA	7	1	142.86	13.44
Union County Sheriff's Office	Union	IN	6	1	166.67	13.30
Woodruff County Sheriff's Office	Woodruff	AR	6	1	166.67	13.77
Estill County Sheriff's Office	Estill	KY	5	1	200.00	6.82
Grant County Sheriff's Office	Grant	OK	5	1	200.00	22.09
Holt County Sheriff's Office	Holt	NE	5	1	200.00	9.58
Kent County Sheriff's Office	Kent	DE	5	1	200.00	0.62
Lake County Sheriff's Office	Lake	SD	5	1	200.00	8.93
Lewis County Sheriff's Office	Lewis	MO	5	1	200.00	9.79

Mesilla Marshal's Office	Dona Ana	NM	5	1	200.00	0.48
Mora County Sheriff's Office	Mora	NM	5	1	200.00	20.49
Oregon County Sheriff's Office	Oregon	MO	5	2	400.00	18.38
Pocahontas County Sheriff's Office	Pocahontas	WV	5	1	200.00	11.47
Terrell County Sheriff's Office	Terrell	TX	5	1	200.00	101.63
Bracken County Sheriff's Office	Bracken	KY	4	1	250.00	11.78
Keokuk County Sheriff's Office	Keokuk	IA	4	1	250.00	9.51
Baker County Sheriff's Office	Baker	GA	3	1	333.33	28.98
Carter County Sheriff's Office	Carter	MO	3	2	666.67	31.92
Gallatin County Sheriff's Office	Gallatin	IL	3	1	333.33	17.89
Griggs County Sheriff's Office	Griggs	ND	3	1	333.33	41.32
Guadalupe County Sheriff's Office	Guadalupe	NM	3	1	333.33	21.34
Nicholas County Sheriff's Office	Nicholas	KY	1	1	1000.00	14.02
Petroleum County Sheriff's Office	Petroleum	MT	1	1	1000.00	202.43
Dale County Sheriff's Office	Dale	AL	0	1		1.99
Westmoreland County Sheriff's Office	Westmoreland	PA	0	1		0.27
Wicomico County Sheriff's Office	Wicomico	MD	0	1		1.01

Appendix A-4. County Police Departments in Study: Rates of Officers Arrested, 2005-2011 (Sorted by # FT Sworn)

Agency	County	State	# of Full-Time Sworn Personnel	Per Agency	Per 1,000 Officers	Per 100,000 Population
Miami-Dade (County) Police Department	Miami-Dade	FL	3093	25	8.08	1.00
Nassau County Police Department	Nassau	NY	2732	6	2.20	0.45
Suffolk County Police Department	Suffolk	NY	2622	6	2.29	0.40
Honolulu (City and County) Police Department	Honolulu	HI	1934	26	13.44	2.73
Baltimore County Police Department	Baltimore	MD	1910	4	2.09	0.50
Charlotte - Mecklenburg Police Department	Mecklenburg	NC	1672	20	11.96	2.17
Indianapolis Police	Marion	IN	1582	33	20.86	3.65
Prince George's County Police Department	Prince Georges	MD	1578	19	12.04	2.20
Fairfax County Police Department	Fairfax	VA	1419	7	4.93	0.65
Montgomery County Police Department	Montgomery	MD	1206	16	13.27	1.65
DeKalb County Police Department	DeKalb	GA	1074	13	12.10	1.88
St. Louis County Police Dept	St. Louis	MO	781	2	2.56	0.20
Gwinnett County Police Department	Gwinnett	GA	682	4	5.87	0.50
Anne Arundel County Police Department	Anne Arundel	MD	633	3	4.74	0.56
Cobb County Police Department	Cobb	GA	590	5	8.47	0.73
Henrico County Division of Police	Henrico	VA	554	4	7.22	1.30
Prince William County Police Department	Prince William	VA	546	3	5.49	0.75
Savannah-Chatham Metropolitan Police Department	Chatham	GA	534	6	11.24	2.26
Chesterfield County Police Department	Chesterfield	VA	475	1	2.11	0.32
Howard County Police Department	Howard	MD	424	3	7.08	1.04
Arlington County Police Department	Arlington	VA	364	1	2.75	0.48
New Castle County Police Department	New Castle	DE	358	2	5.59	0.37
Clayton County Police Department	Clayton	GA	336	3	8.93	1.16
Maui (County) Police Department	Maui	HI	329	5	15.20	3.23
Westchester County Department of Public Safety	Westchester	NY	270	3	11.11	0.32
Horry County Police Department	Horry	SC	243	9	37.04	3.34
Henry County Police Department	Henry	GA	225	1	4.44	0.49
Athens-Clarke County Police Dept	Clarke	GA	213	2	9.39	1.71
Allegheny County Police Department.	Allegheny	PA	202	2	9.90	0.16
Roanoke County Police Department	Roanoke	VA	135	2	14.81	2.17
Gaston County Police Department	Gaston	NC	133	2	15.04	0.97
Fulton County Police Department	Fulton	GA	129	2	15.50	0.22

Kauai (County) Police Department	Kauai	HI	125	3	24.00	4.47
Riley County Police Department	Riley	KS	101	1	9.90	1.41
James City County Police Dept.	James City	VA	94	1	10.64	1.49
Floyd County Police Department	Floyd	GA	71	1	14.08	1.04
Dougherty County Police Dept.	Dougherty	GA	47	2	42.55	2.11
Polk County Police Department	Polk	GA	35	3	85.71	7.23
Oldham County Police Department	Oldham	KY	31	2	64.52	3.32

Appendix A-5. 500 Largest Municipal Police Departments in Study: Rates of Officers Arrested, 2005-2011 (Sorted by # FT Sworn)

Agency	County	State	# of Full-Time Sworn Personnel	Per Agency	Per 1,000 Officers	Per 100,000 Population
New York City Police Department	New York	NY	36023	196	5.44	2.40
Chicago Police Dept	Cook	IL	13354	83	6.22	1.60
Los Angeles Police Department	Los Angeles	CA	9727	30	3.08	0.31
Philadelphia Police Department	Philadelphia	PA	6624	66	9.96	4.33
Houston Police Department	Harris	TX	5053	35	6.93	0.86
Washington Metropolitan Police Dept	District of Columbia	DC	3742	29	7.75	4.82
Dallas Police Department	Dallas	TX	3389	39	11.51	1.65
Phoenix Police Department	Maricopa	AZ	3388	17	5.02	0.45
Baltimore Police Department	Baltimore City	MD	2990	55	18.39	8.86
Las Vegas Metro Police Department	Clark	NV	2942	8	2.72	0.41
Detroit Police Department	Wayne	MI	2250	23	10.22	1.26
Boston Police Department	Suffolk	MA	2181	14	6.42	1.94
San Antonio Police Department	Bexar	TX	2020	30	14.85	1.75
Milwaukee Police Department	Milwaukee	WI	1987	73	36.74	7.70
San Diego Police Department	San Diego	CA	1951	12	6.15	0.39
San Francisco Police Department	San Francisco	CA	1940	7	3.61	0.87
Columbus Police Department	Franklin	OH	1886	9	4.77	0.77
Atlanta Police Department	Fulton	GA	1719	22	12.80	2.39
Jacksonville Sheriff's Office	Duval	FL	1662	12	7.22	1.39
Cleveland Police Department	Cuyahoga	OH	1616	27	16.71	2.11
Memphis Police Department	Shelby	TN	1549	46	29.70	4.96
Denver Police Department	Denver	CO	1525	13	8.52	2.17
Austin Police Department	Travis	TX	1515	10	6.60	0.98
Fort Worth Police Department	Tarrant	TX	1489	20	13.43	1.11
New Orleans Police Department	Orleans	LA	1425	63	44.21	18.32
Kansas City Police Department	Jackson	MO	1421	5	3.52	0.74
San Jose Police Department	Santa Clara	CA	1382	9	6.51	0.51
St. Louis (city) Police Dept	St. Louis City	MO	1351	10	7.40	3.13
Nashville Metro Police Department	Davidson	TN	1315	18	13.69	2.87
Newark Police	Essex	NJ	1310	8	6.11	1.02
Seattle Police Department	King	WA	1283	9	7.01	0.47
Louisville Metro Police Department	Jefferson	KY	1197	16	13.37	2.16

El Paso Police Department	El Paso	TX	1132	15	13.25	1.87
Miami Police Department	Miami-Dade	FL	1104	14	12.68	0.56
Cincinnati Police Department	Hamilton	OH	1082	10	9.24	1.25
Oklahoma City Police Department	Oklahoma	OK	1046	12	11.47	1.67
Tucson Police Department	Pima	AZ	1032	6	5.81	0.61
Albuquerque Police Department	Bernalillo	NM	1020	13	12.75	1.96
Tampa Police Department	Hillsborough	FL	980	3	3.06	0.24
Long Beach Police Department	Los Angeles	CA	968	4	4.13	0.04
Portland Police Bureau	Multnomah	OR	928	10	10.78	1.36
Minneapolis Police Department	Hennepin	MN	902	18	19.96	1.56
Jersey City Police	Hudson	NJ	900	12	13.33	1.89
Pittsburgh Police Department	Allegheny	PA	891	21	23.57	1.72
Mesa Police Department	Maricopa	AZ	831	2	2.41	0.05
Fresno Police Department	Fresno	CA	828	7	8.45	0.75
Tulsa Police Department	Tulsa	OK	826	11	13.32	1.82
Birmingham Police Department	Jefferson	AL	816	8	9.80	1.21
Virginia Beach Police Department	Virginia Beach City	VA	813	9	11.07	2.05
Buffalo Police Department	Erie	NY	793	4	5.04	0.44
Oakland Police Department	Alameda	CA	773	3	3.88	0.20
Norfolk Police Department	Norfolk City	VA	772	14	18.13	5.77
Orlando Police Department	Orange	FL	757	8	10.57	0.70
Richmond Police Department	Richmond City	VA	752	7	9.31	3.43
Omaha Police Dept	Douglas	NE	747	6	8.03	1.16
Rochester Police Department	Monroe	NY	703	3	4.27	0.40
Raleigh Police Department	Wake	NC	702	8	11.40	0.89
Sacramento Police Department	Sacramento	CA	701	5	7.13	0.35
Colorado Springs Police Department	El Paso	CO	668	5	7.49	0.80
Wichita Police Department	Sedgwick	KS	662	2	3.02	0.40
Yonkers Police Department	Westchester	NY	641	2	3.12	0.21
Toledo Police Department	Lucas	OH	640	12	18.75	2.72
Baton Rouge Police Department	East Baton Rouge	LA	630	6	9.52	1.36
Aurora Police Department	Arapahoe	CO	627	6	9.57	1.05
Arlington Police Department	Tarrant	TX	610	3	4.92	0.17
St. Paul Police Department	Ramsey	MN	598	8	13.38	1.57
Greensboro Police Department	Guilford	NC	593	5	8.43	1.02
Little Rock Police Department	Pulaski	AR	520	2	3.85	0.52

Mobile Police Department	Mobile	AL	515	4	7.77	0.97
Shreveport Police Department	Caddo	LA	511	12	23.48	4.71
St. Petersburg Police Department	Pinellas	FL	510	6	11.76	0.65
Winston-Salem Police Department	Forsyth	NC	508	3	5.91	0.86
Montgomery Police Department	Montgomery	AL	500	6	12.00	2.62
Paterson Police	Passaic	NJ	497	3	6.04	0.60
Durham Police Department	Durham	NC	494	9	18.22	3.36
Syracuse Police Department	Onondaga	NY	489	3	6.13	0.64
Providence Police Department	Providence	RI	483	7	14.49	1.12
Fort Lauderdale Police Department	Broward	FL	482	6	12.45	0.34
Worcester Police Department	Worcester	MA	482	5	10.37	0.63
Jackson Police Department	Hinds	MS	480	9	18.75	3.67
Akron Police Department	Summit	OH	472	8	16.95	1.48
North Las Vegas Police Department	Clark	NV	471	2	4.25	0.10
Springfield Police Department	Hampden	MA	464	9	19.40	1.94
Corpus Christi Police Department	Nueces	TX	448	3	6.70	0.88
Fort Wayne Police	Allen	IN	447	4	8.95	1.13
Madison Police Department	Dane	WI	437	1	2.29	0.20
New Haven Police Department	New Haven	CT	436	8	18.35	0.93
Chattanooga Police Department	Hamilton	TN	434	14	32.26	4.16
Salt Lake City Police Department	Salt Lake	UT	433	1	2.31	0.10
Laredo Police Department	Webb	TX	430	4	9.30	1.60
Bridgeport Police Department	Fairfield	CT	422	3	7.11	0.33
Dayton Police Department	Montgomery	OH	421	1	2.38	0.19
Scottsdale Police Dept	Maricopa	AZ	417	1	2.40	0.03
Newport News Police Department	Newport News City	VA	415	10	24.10	5.53
Stockton Police Department	San Joaquin	CA	415	2	4.82	0.29
Hartford Police Department	Hartford	CT	408	10	24.51	1.12
Huntsville Police Department	Madison	AL	405	3	7.41	0.90
Columbus Police Department	Muscogee	GA	400	6	15.00	3.16
Anaheim Police Department	Orange	CA	398	3	7.54	0.10
Camden Police	Camden	NJ	397	10	25.19	1.95
Des Moines Police Department	Polk	IA	385	6	15.58	1.39
Riverside Police Department	Riverside	CA	385	4	10.39	0.18
Charleston Police Department	Charleston	SC	382	2	5.24	0.57
Chesapeake Police Department	Chesapeake City	VA	376	3	7.98	1.35

Lubbock Police Department	Lubbock	TX	376	5	13.30	1.79
Miami Beach Police Department	Miami-Dade	FL	374	3	8.02	0.12
Anchorage Police Department	Anchorage	AK	372	4	10.75	1.37
Tacoma Police Department	Pierce	WA	371	3	8.09	0.38
Tallahassee Police Department	Leon	FL	364	1	2.75	0.36
Reno Police Department	Washoe	NV	362	3	8.29	0.71
Trenton Police	Mercer	NJ	361	6	16.62	1.64
Tempe Police Department	Maricopa	AZ	357	1	2.80	0.03
Kansas City Police Department	Wyandotte	KS	354	10	28.25	6.35
Columbia Police Department	Richland	SC	351	8	22.79	2.08
Bakersfield Police Department	Kern	CA	348	8	22.99	0.95
Elizabeth Police	Union	NJ	348	1	2.87	0.19
San Bernardino Police Department	San Bernardino	CA	345	2	5.80	0.10
Irving Police Department	Dallas	TX	344	2	5.81	0.08
Plano Police Department	Collin	TX	343	1	2.92	0.13
Salt Lake County Sheriff's Office	Salt Lake	UT	342	1	2.92	0.10
Fayetteville Police Department	Cumberland	NC	341	2	5.87	0.63
Hialeah Police Department	Miami-Dade	FL	338	1	2.96	0.04
Henderson Police Department	Clark	NV	336	2	5.95	0.10
Chandler Police Department	Maricopa	AZ	333	2	6.01	0.05
Albany Police Department	Albany	NY	328	7	21.34	2.30
North Charleston Police Department	Charleston	SC	325	5	15.38	1.43
Grand Rapids Police Department	Kent	MI	319	1	3.13	0.17
Hollywood Police Department	Broward	FL	316	8	25.32	0.46
Alexandria Police Department	Alexandria City	VA	315	3	9.52	2.14
West Palm Beach Police Department	Palm Beach	FL	310	3	9.68	0.23
Lincoln Police Dept	Lancaster	NE	308	1	3.25	0.35
Boise Police Department	Ada	ID	306	2	6.54	0.51
Springfield Police Dept	Greene	MO	306	3	9.80	1.09
Wilmington Police Department	New Castle	DE	306	2	6.54	0.37
Joliet Police Dept	Will	IL	302	3	9.93	0.44
Rockford Police Dept	Winnebago	IL	300	1	3.33	0.34
Spokane Police Department	Spokane	WA	295	6	20.34	1.27
Stamford Police Department	Fairfield	CT	292	3	10.27	0.33
New Bedford Police Department	Bristol	MA	288	2	6.94	0.36
East Orange Police	Essex	NJ	283	3	10.60	0.38

Topeka Police Department	Shawnee	KS	283	4	14.13	2.25
Evansville Police	Vanderburgh	IN	277	3	10.83	1.67
Gainesville Police Department	Alachua	FL	275	4	14.55	1.62
McAllen Police Department	Hidalgo	TX	273	3	10.99	0.39
Springfield Police Dept	Sangamon	IL	273	1	3.66	0.51
Cambridge Police Department	Middlesex	MA	272	1	3.68	0.07
Macon Police Department	Bibb	GA	270	9	33.33	5.79
Wilmington Police Department	New Hanover	NC	266	2	7.52	0.99
Glendale Police Department	Los Angeles	CA	264	1	3.79	0.01
Roanoke City Police Department	Roanoke City	VA	264	2	7.58	2.06
Tuscaloosa Police Department	Tuscaloosa	AL	263	1	3.80	0.51
Modesto Police Department	Stanislaus	CA	262	5	19.08	0.97
Pasadena Police Department	Harris	TX	260	5	19.23	0.12
Waterbury Police Department	New Haven	CT	256	4	15.63	0.46
Clearwater Police Department	Pinellas	FL	255	1	3.92	0.11
South Bend Police	St. Joseph	IN	255	8	31.37	3.00
Daytona Beach Police Department	Volusia	FL	250	6	24.00	1.21
Beaumont Police Department	Jefferson	TX	246	2	8.13	0.79
Peoria Police Dept	Peoria	IL	246	1	4.07	0.54
Waco Police Department	McLennan	TX	246	8	32.52	3.41
Port St. Lucie Police Department	St. Lucie	FL	245	1	4.08	0.36
Chula Vista Police Department	San Diego	CA	244	1	4.10	0.03
Kalamazoo Dept of Public Safety	Kalamazoo	MI	244	1	4.10	0.40
Gary Police	Lake	IN	243	10	41.15	2.02
Lafayette Police Department	Lafayette	LA	243	1	4.12	0.45
Lansing Police Department	Ingham	MI	240	3	12.50	1.07
Lowell Police Department	Middlesex	MA	239	2	8.37	0.13
Clarksville Police Department	Montgomery	TN	238	5	21.01	7.54
Pembroke Pines Police Department	Broward	FL	238	1	4.20	0.06
Fall River Police Department	Bristol	MA	237	1	4.22	0.18
Portsmouth Police Department	Portsmouth City	VA	235	10	42.55	10.47
Hampton Police Department	Hampton City	VA	232	2	8.62	1.46
Brownsville Police Department	Cameron	TX	230	1	4.35	0.25
Warren Police Department	Macomb	MI	230	1	4.35	0.12
Oxnard Police Department	Ventura	CA	228	3	13.16	0.36
Lakeland Police Department	Polk	FL	226	5	22.12	0.83

Mesquite Police Department	Dallas	TX	226	1	4.42	0.04
Huntington Beach Police Department	Orange	CA	223	1	4.48	0.03
Sioux Falls Police Department	Minnehaha	SD	221	1	4.52	0.59
Cape Coral Police Department	Lee	FL	220	2	9.09	0.32
Manchester Police Department	Hillsborough	NH	218	1	4.59	0.25
Murfreesboro Police Department	Rutherford	TN	213	5	23.47	1.90
Oceanside Police Department	San Diego	CA	210	4	19.05	0.13
White Plains Police Department	Westchester	NY	210	1	4.76	0.11
Independence Police Department	Jackson	MO	206	1	4.85	0.15
Woodbridge Police	Middlesex	NJ	206	1	4.85	0.12
Mount Vernon Police Department	Westchester	NY	205	1	4.88	0.11
Quincy Police Department	Norfolk	MA	205	1	4.88	0.15
Flint Police Department	Genesee	MI	204	6	29.41	1.41
Jackson Police Department	Madison	TN	204	4	19.61	4.07
Allentown Police Department	Lehigh	PA	200	1	5.00	0.29
Dearborn Police Department	Wayne	MI	198	4	20.20	0.22
Everett Police Department	Snohomish	WA	198	1	5.05	0.14
Brockton Police Department	Plymouth	MA	197	3	15.23	0.61
Cedar Rapids Police Department	Linn	IA	197	2	10.15	0.95
Irvine Police Department	Orange	CA	197	1	5.08	0.03
Pueblo Police Dept	Pueblo	CO	195	4	20.51	2.51
Racine Police Department	Racine	WI	195	1	5.13	0.51
Gulfport Police Department	Harrison	MS	193	1	5.18	0.53
Irvington Police	Essex	NJ	190	2	10.53	0.26
Killeen Police Department	Bell	TX	190	3	15.79	0.97
Edison Police	Middlesex	NJ	189	7	37.04	0.86
Peoria Police Department	Maricopa	AZ	189	1	5.29	0.03
Monroe Police Department	Ouachita	LA	188	1	5.32	0.65
Inglewood Police Department	Los Angeles	CA	187	1	5.35	0.01
Salem Police Department	Marion	OR	187	1	5.35	0.32
Berkeley Police Department	Alameda	CA	186	1	5.38	0.07
West Valley City Police Department	Salt Lake	UT	186	1	5.38	0.10
Hayward Police Department	Alameda	CA	185	1	5.41	0.07
New Rochelle Police Department	Westchester	NY	185	2	10.81	0.21
Albany Police Department	Dougherty	GA	184	4	21.74	4.23
Coral Gables Police Department	Miami-Dade	FL	184	2	10.87	0.08

Naperville Police Dept	Du Page	IL	184	1	5.43	0.11
Charleston Police Department	Kanawha	WV	182	9	49.45	4.66
Fremont Police Department	Alameda	CA	182	1	5.49	0.07
Elgin Police Dept	Kane	IL	181	5	27.62	0.97
Myrtle Beach Police Department	Horry	SC	179	5	27.93	1.86
Utica Police Department	Oneida	NY	179	2	11.17	0.85
Bossier City Police Dept	Bossier	LA	178	3	16.85	2.56
Greenville Police Department	Greenville	SC	178	4	22.47	0.89
Lynn Police Department	Essex	MA	178	2	11.24	0.27
Westminster Police Dept	Adams	CO	178	4	22.47	0.91
Salinas Police Department	Monterey	CA	177	4	22.60	0.96
Wichita Falls Police Department	Wichita	TX	177	2	11.30	1.52
Sunrise Police Department	Broward	FL	175	1	5.71	0.06
Canton Police Department	Stark	OH	172	1	5.81	0.27
Nashua Police Department	Hillsborough	NH	172	1	5.81	0.25
Miramar Police Department	Broward	FL	171	2	11.70	0.11
Suffolk Police Department	Suffolk	VA	171	1	5.85	1.18
Fort Myers Police Department	Lee	FL	170	4	23.53	0.65
Erie Police Department	Erie	PA	167	1	5.99	0.36
Las Cruces Police Department	Dona Ana	NM	167	1	5.99	0.48
Norwalk Police Department	Fairfield	CT	167	5	29.94	0.55
Yuma Police Department	Yuma	AZ	167	2	11.98	1.02
Decatur Police Dept	Macon	IL	166	1	6.02	0.90
Garden Grove Police Department	Orange	CA	166	2	12.05	0.07
Gastonia Police Department	Gaston	NC	166	2	12.05	0.97
Schenectady Police Department	Schenectady	NY	166	8	48.19	5.17
Boulder Police Department	Boulder	CO	165	1	6.06	0.34
Boynton Beach Police Department	Palm Beach	FL	165	7	42.42	0.53
Lawton Police Department	Comanche	OK	165	1	6.06	0.81
Richmond Police Department	Contra Costa	CA	165	3	18.18	0.29
Union City Police	Hudson	NJ	165	3	18.18	0.47
Davie Police Department	Broward	FL	164	2	12.20	0.11
Melbourne Police Department	Brevard	FL	163	1	6.13	0.18
Fort Collins Police Department	Larimer	CO	162	3	18.52	1.00
Kenner Police Department	Jefferson	LA	162	1	6.17	0.23
Concord Police Department	Contra Costa	CA	161	1	6.21	0.10

Galveston Police Department	Galveston	TX	161	1	6.21	0.34
Lancaster Police Department	Lancaster	PA	161	2	12.42	0.39
Olathe Police Department	Johnson	KS	161	1	6.21	0.18
Ann Arbor Police Department	Washtenaw	MI	160	4	25.00	1.16
New Britain Police Department	Hartford	CT	160	2	12.50	0.22
Fullerton Police Department	Orange	CA	159	3	18.87	0.10
Palm Bay Police Department	Brevard	FL	159	1	6.29	0.18
Portland Police Department	Cumberland	ME	159	3	18.87	1.07
Clifton Police	Passaic	NJ	158	1	6.33	0.20
Costa Mesa Police Department	Orange	CA	158	1	6.33	0.03
Fort Smith Police Department	Sebastian	AR	158	3	18.99	2.39
Vineland Police	Cumberland	NJ	157	2	12.74	1.27
Hoboken Police	Hudson	NJ	156	3	19.23	0.47
Columbia Police Department	Boone	MO	155	1	6.45	0.61
Denton Police Department	Denton	TX	155	1	6.45	0.15
Harrisburg Police Department	Dauphin	PA	155	1	6.45	0.37
Ocala Police Department	Marion	FL	155	2	12.90	0.60
Scranton Police Department	Lackawanna	PA	155	4	25.81	1.87
Waukegan Police Dept	Lake	IL	155	2	12.90	0.28
Bethlehem Police Department	Northampton	PA	154	4	25.97	1.34
Concord Police Department	Cabarrus	NC	153	1	6.54	0.56
Danbury Police Department	Fairfield	CT	153	1	6.54	0.11
Lake Charles Police Department	Calcasieu	LA	153	2	13.07	1.04
Midland Police Department	Midland	TX	153	1	6.54	0.73
Pawtucket Police Department	Providence	RI	153	2	13.07	0.32
Delray Beach Police Department	Palm Beach	FL	152	1	6.58	0.08
Lawrence Police Department	Essex	MA	151	4	26.49	0.54
Plainfield Police Department	Union	NJ	151	5	33.11	0.93
Santa Fe Police Department	Santa Fe	NM	150	2	13.33	1.39
Cranston Police Department	Providence	RI	148	3	20.27	1.81
Dothan Police Department	Houston	AL	148	2	13.51	1.97
Cicero Police Dept	Cook	IL	146	4	27.40	0.08
Greeley Police Department	Weld	CO	146	2	13.70	0.79
Johnson City Police Department	Washington	TN	146	1	6.85	0.81
Pensacola Police Department	Escambia	FL	146	1	6.85	0.34
Cherry Hill Police	Camden	NJ	145	2	13.79	0.39

Niagara Falls Police Department	Niagara	NY	145	3	20.69	1.39
Rocky Mount Police Department	Nash	NC	143	1	6.99	1.77
Santa Clara Police Department	Santa Clara	CA	141	2	14.18	0.11
Largo Police Department	Pinellas	FL	140	1	7.14	0.11
Newport Beach Police Department	Orange	CA	140	1	7.14	0.03
Pine Bluff Police Department	Jefferson	AR	140	1	7.14	1.29
Binghamton Police Department	Broome	NY	139	1	7.19	0.50
Billings Police Department	Yellowstone	MT	138	2	14.49	1.35
Frederick Police Department	Frederick	MD	138	1	7.25	0.43
New Brunswick Police	Middlesex	NJ	138	2	14.49	0.25
Mount Pleasant Police Department	Charleston	SC	137	1	7.30	0.29
Ogden Police Department	Weber	UT	137	2	14.60	0.86
Baytown Police Department	Harris	TX	136	1	7.35	0.02
Kissimmee Police Department	Osceola	FL	136	3	22.06	1.12
Longmont Police Department	Boulder	CO	136	1	7.35	0.34
Newton Police Department	Middlesex	MA	136	1	7.35	0.07
Santa Barbara Police Department	Santa Barbara	CA	136	1	7.35	0.24
Visalia Department of Public Safety	Tulare	CA	136	1	7.35	0.23
Hamilton Police Department	Butler	OH	135	1	7.41	0.27
Yakima Police Department	Yakima	WA	134	1	7.46	0.41
Biloxi Police Department	Harrison	MS	133	2	15.04	1.07
Chicopee Police Department	Hampden	MA	133	1	7.52	0.22
Decatur Police Department	Morgan	AL	133	1	7.52	0.84
Federal Way Police Department	King	WA	133	1	7.52	0.05
Marietta Police Department	Cobb	GA	133	1	7.52	0.15
Round Rock Police Department	Williamson	TX	133	1	7.52	0.24
Valdosta Police Department	Lowndes	GA	133	1	7.52	0.92
Sanford Police Department	Seminole	FL	131	1	7.63	0.24
Somerville Police Department	Middlesex	MA	130	2	15.38	0.13
Sugar Land Police Department	Fort Bend	TX	130	2	15.38	0.34
Brookline Police Department	Norfolk	MA	129	3	23.26	0.45
Farmington Police Department	San Juan	NM	129	5	38.76	3.84
Gresham Police Department	Multnomah	OR	129	1	7.75	0.14
Lafayette Police	Tippecanoe	IN	128	1	7.81	0.58
Brick Township Police	Ocean	NJ	127	1	7.87	0.17
Springfield Police Department	Clark	OH	127	1	7.87	0.72

Surprise Police Department	Maricopa	AZ	127	1	7.87	0.03
Danville Police Department	Pittsylvania	VA	126	1	7.94	1.57
Elk Grove Police Department	Sacramento	CA	126	1	7.94	0.38
Fort Pierce Police Department	St. Lucie	FL	126	4	31.75	1.44
Hattiesburg Police Department	Forrest	MS	126	2	15.87	2.67
Mission Police Department	Hidalgo	TX	125	2	16.00	0.26
Rochester Police Department	Olmsted	MN	125	1	8.00	0.69
Altamonte Springs Police Department	Seminole	FL	124	1	8.06	0.24
Beaverton Police Department	Washington	OR	124	1	8.06	0.19
Broken Arrow Police Department	Tulsa	OK	124	2	16.13	0.33
Elkhart Police	Elkhart	IN	124	4	32.26	2.02
Harlingen Police Department	Cameron	TX	123	1	8.13	0.25
Holyoke Police Department	Hampden	MA	123	1	8.13	0.22
North Bergen Police	Hudson	NJ	123	1	8.13	0.16
Bloomington Police Dept	McLean	IL	122	2	16.39	1.18
Bolingbrook Police Dept	Will	IL	122	3	24.59	0.44
Champaign Police Dept	Champaign	IL	122	1	8.20	0.50
West Haven Police Department	New Haven	CT	122	2	16.39	0.23
Rock Hill Police Department	York	SC	121	1	8.26	0.44
Troy Police Department	Rensselaer	NY	121	1	8.26	0.63
El Cajon Police Department	San Diego	CA	120	1	8.33	0.03
Ramapo Town Police Department	Rockland	NY	120	1	8.33	0.32
Sandy Springs Police Department	Fulton	GA	120	3	25.00	0.33
Waterloo Police Department	Black Hawk	IA	120	4	33.33	3.05
Bristol Police Department	Hartford	CT	119	1	8.40	0.11
West New York Police	Hudson	NJ	119	1	8.40	0.16
Framingham Police Department	Middlesex	MA	118	1	8.47	0.07
Redding Police Department	Shasta	CA	118	1	8.47	0.56
Anderson Police	Madison	IN	117	4	34.19	3.04
Fayetteville Police Department	Washington	AR	117	2	17.09	0.98
Hackensack Police	Bergen	NJ	117	9	76.92	0.99
Wayne Township Police	Passaic	NJ	117	1	8.55	0.20
East Point Police Department	Fulton	GA	116	2	17.24	0.22
Manchester Police Department	Hartford	CT	116	2	17.24	0.22
Charlottesville Police Dept.	Charlottesville City	VA	115	1	8.70	2.30
Lauderhill Police Department	Broward	FL	115	1	8.70	0.06

Oak Park Police Dept	Cook	IL	115	1	8.70	0.02
Ottawa County Sheriff's Office	Ottawa	MI	115	1	8.70	0.38
Tupelo Police Department	Lee	MS	115	1	8.70	1.21
Hickory Police Department	Catawba	NC	114	1	8.77	0.65
Palm Beach Gardens Police Department	Palm Beach	FL	114	2	17.54	0.15
St. Joseph Police Dept	Buchanan	MO	114	1	8.77	1.12
Wilson Police Department	Wilson	NC	114	2	17.54	2.46
Daly City Police Department	San Mateo	CA	113	1	8.85	0.14
Flagstaff Police Department	Coconino	AZ	113	1	8.85	0.74
Meriden Police Department	New Haven	CT	113	1	8.85	0.12
Covington Police Department	Kenton	KY	112	1	8.93	0.63
Hempstead Village Police Department	Nassau	NY	112	1	8.93	0.07
St. Charles Police Dept	St. Charles	MO	112	1	8.93	0.28
Gloucester Township Police	Camden	NJ	111	2	18.02	0.39
Kingsport Police Department	Sullivan	TN	111	3	27.03	1.91
Stratford Police Department	Fairfield	CT	111	3	27.03	0.33
Vacaville Police Department	Solano	CA	111	1	9.01	0.24
Barnstable Police Department	Barnstable	MA	110	2	18.18	0.93
East Chicago Police	Lake	IN	110	2	18.18	0.40
Edinburg Police Department	Hidalgo	TX	110	5	45.45	0.65
Edmond Police Department	Oklahoma	OK	110	2	18.18	0.28
Medford Police Department	Middlesex	MA	110	1	9.09	0.07
Milford Police Department	New Haven	CT	110	1	9.09	0.12
Sandy Police Department	Salt Lake	UT	110	1	9.09	0.10
York Police Department	York	PA	110	1	9.09	0.23
Colonie Town Police Department	Albany	NY	109	2	18.35	0.66
Florence Police Department	Florence	SC	109	2	18.35	1.46
Grand Junction Police Department	Mesa	CO	108	2	18.52	1.36
Riviera Beach Police Department	Palm Beach	FL	108	6	55.56	0.45
Ocean City Police Department	Worcester	MD	107	1	9.35	1.94
O'Fallon Police Department	St. Charles	MO	107	1	9.35	0.28
Rapid City Police Department	Pennington	SD	107	2	18.69	1.98
Sumter Police Department	Sumter	SC	107	3	28.04	2.79
Allen Police Department	Collin	TX	106	2	18.87	0.26
Homestead Police Department	Miami-Dade	FL	106	3	28.30	0.12
Oak Lawn Police Dept	Cook	IL	106	1	9.43	0.02

Victoria Police Department	Victoria	TX	106	2	18.87	2.30
Bartlett Police Department	Shelby	TN	105	1	9.52	0.11
Berwyn Police Dept	Cook	IL	105	3	28.57	0.06
Broomfield Police Department	Broomfield	CO	105	1	9.52	1.79
Burlington Police Department	Alamance	NC	105	3	28.57	1.99
Council Bluffs Police Department	Pottawattomie	IA	105	1	9.52	1.07
Hagerstown Police Department	Washington	MD	105	1	9.52	0.68
Hamden Police Department	New Haven	CT	105	2	19.05	0.23
Merced Police Department	Merced	CA	105	1	9.52	0.39
Newburgh City Police Department	Orange	NY	105	1	9.52	0.27
Poughkeepsie Police Department	Dutchess	NY	105	1	9.52	0.34
Bensalem Township Police Department	Bucks	PA	104	1	9.62	0.16
Carmel Police	Hamilton	IN	104	3	28.85	1.09
Lakewood Police Department	Pierce	WA	103	1	9.71	0.13
Medford Police Department	Jackson	OR	103	2	19.42	0.98
Oro Valley Police Department	Pima	AZ	103	1	9.71	0.10
Des Plaines Police Dept	Cook	IL	102	1	9.80	0.02
Jupiter Police Department	Palm Beach	FL	102	1	9.80	0.08
Muncie Police	Delaware	IN	102	3	29.41	2.55
Southampton Town Police Department	Suffolk	NY	102	1	9.80	0.07
West Jordan Police Department	Salt Lake	UT	102	2	19.61	0.19
Goldsboro Police Department	Wayne	NC	101	1	9.90	0.82
Dubuque Police Department	Dubuque	IA	100	3	30.00	3.20
Euclid Police Department	Cuyahoga	OH	100	1	10.00	0.08
Kokomo Police	Howard	IN	100	1	10.00	1.21
Lorain Police Department	Lorain	OH	100	5	50.00	1.66
Missoula Police Department	Missoula	MT	100	1	10.00	0.91
Westminster Police Department	Orange	CA	100	2	20.00	0.07
Conroe Police Department	Montgomery	TX	99	2	20.20	0.44
Meridian Police Department	Lauderdale	MS	99	3	30.30	3.74
Middletown Police Department	Middlesex	CT	99	2	20.20	1.21
Pinellas Park Police Department	Pinellas	FL	99	2	20.20	0.22
Provo Police Department	Utah	UT	99	3	30.30	0.58
Redondo Beach Police Department	Los Angeles	CA	99	1	10.10	0.01
Rogers Police Department	Benton	AR	99	1	10.10	0.45
Woonsocket Police Department	Providence	RI	99	4	40.40	0.64

East Providence Police Department	Providence	RI	98	1	10.20	0.16
Eau Claire Police Department	Eau Claire	WI	96	1	10.42	1.01
Greenville Police Department	Washington	MS	96	2	20.83	3.91
Pharr Police Department	Hidalgo	TX	96	2	20.83	0.26
Weymouth Police Department	Norfolk	MA	96	1	10.42	0.15
Egg Harbor Township Police	Atlantic	NJ	95	2	21.05	0.73
Enfield Police Department	Hartford	CT	95	4	42.11	0.45
San Leandro Police Department	Alameda	CA	95	2	21.05	0.13
San Marcos Police Department	Hays	TX	95	1	10.53	0.64
Alameda Police Department	Alameda	CA	94	2	21.28	0.13
Florence Police Department	Lauderdale	AL	94	1	10.64	1.08
Greece Town Police Department	Monroe	NY	94	4	42.55	0.54
Texarkana Police Department	Bowie	TX	94	1	10.64	1.08
College Park Police Department	Fulton	GA	93	1	10.75	0.11
Haverhill Police Department	Essex	MA	93	1	10.75	0.13
Palm Springs Police Department	Riverside	CA	93	1	10.75	0.05
Palo Alto Police Department	Santa Clara	CA	93	1	10.75	0.06
Bellevue Police Dept	Sarpy	NE	92	1	10.87	0.63
Chelsea Police Department	Suffolk	MA	92	1	10.87	0.14
Joplin Police Department	Jasper	MO	92	1	10.87	0.85
New Braunfels Police Department	Comal	TX	92	2	21.74	1.84
Parma Police Department	Cuyahoga	OH	92	3	32.61	0.23
Saginaw Police Department	Saginaw	MI	92	1	10.87	0.50
Wilkes Barre City Police Department	Luzerne	PA	92	1	10.87	0.31
Anderson Police Department	Anderson	SC	91	3	32.97	1.60
Calumet City Police Dept	Cook	IL	91	1	10.99	0.02
Dover Police Department	Kent	DE	90	2	22.22	1.23
Grapevine Police Department	Tarrant	TX	90	1	11.11	0.06
Kennewick Police Department	Benton	WA	90	1	11.11	0.57
Muskogee Police Department	Muskogee	OK	90	4	44.44	5.63
New Bern Police Department	Craven	NC	90	1	11.11	0.97
New London Police Department	New London	CT	90	2	22.22	0.73
Orangetown Town Police Department	Rockland	NY	90	1	11.11	0.32
Orem Department of Public Safety	Utah	UT	90	1	11.11	0.19
Piscataway Township Police	Middlesex	NJ	90	1	11.11	0.12
West Chester Police Department	Butler	OH	90	1	11.11	0.27

Cleveland Police Department	Bradley	TN	89	4	44.94	4.04
Coconut Creek Police Department	Broward	FL	89	3	33.71	0.17
Idaho Falls Police Department	Bonneville	ID	89	1	11.24	0.96
Chico Police Department	Butte	CA	88	2	22.73	0.91
Folsom Police Department	Sacramento	CA	88	2	22.73	0.14
Jefferson City Police Department	Cole	MO	88	1	11.36	1.32
Salisbury Police Department	Wicomico	MD	88	1	11.36	1.01
Titusville Police Department	Brevard	FL	88	1	11.36	0.18
Bend Police Department	Deschutes	OR	86	2	23.26	1.27
Cuyahoga Falls Police Department	Summit	OH	86	2	23.26	0.37
Elyria Police Department	Lorain	OH	86	2	23.26	0.66
Michigan City Police	La Porte	IN	86	1	11.63	0.90
Panama City Police Department	Bay	FL	86	1	11.63	0.59
Revere Police Department	Suffolk	MA	86	1	11.63	0.14
Salisbury Police Department	Rowan	NC	86	1	11.63	0.72
Washington Township Police	Gloucester	NJ	86	1	11.63	0.35
Apopka Police Department	Orange	FL	85	1	11.76	0.09
Moline Police Department	Rock Island	IL	85	1	11.76	0.68
Pleasanton Police Department	Alameda	CA	85	1	11.76	0.07
Royal Oak Police Department	Oakland	MI	85	1	11.76	0.08
Texas City Police Department	Galveston	TX	85	2	23.53	0.69
Wheeling Police Department	Ohio	WV	84	2	23.81	4.50
Alhambra Police Department	Los Angeles	CA	83	1	12.05	0.01
Citrus Heights Police Department	Sacramento	CA	83	1	12.05	0.07
Eules Police Department	Tarrant	TX	83	1	12.05	0.06
LaGrange Police Department	Troup	GA	83	1	12.05	1.49
North Brunswick Police	Middlesex	NJ	83	1	12.05	0.12
Port Orange Police Department	Volusia	FL	83	2	24.10	0.40
Salem Police Department	Essex	MA	83	2	24.10	0.27
Mentor Police Department	Lake	OH	82	1	12.20	0.43
Petersburg Police Department	Petersburg City	VA	82	2	24.39	6.17
Belleville Police Dept	St. Clair	IL	81	1	12.35	0.37
Downers Grove Police Dept	Du Page	IL	81	1	12.35	0.11
Norwich Police Department	New London	CT	81	5	61.73	1.82
Sanford Police Department	Lee	NC	81	1	12.35	1.73
Tinley Park Police Dept	Cook	IL	81	2	24.69	0.04

West Bloomfield Township Police Dept	Oakland	MI	81	1	12.35	0.08
--------------------------------------	---------	----	----	---	-------	------

Appendix A-6. Special State & Local Law Enforcement Agencies in Study: Rates of Officers Arrested, 2005-2011 (Sorted by # FT Sworn)

Agency	County	State	# of Full-Time Sworn Personnel	Per Agency	Per 1,000 Officers	Per 100,000 Population
Port Authority of New York & New Jersey Police Dept	Hudson	NJ	1667	1	0.60	0.16
New York State Metro Transportation Auth. Police	New York	NY	694	2	2.88	0.13
Florida Fish & Wildlife Conservation Commission	Leon	FL	626	4	6.39	0.44
District of Columbia Protective Services Police	District of Columbia	DC	484	1	2.07	0.17
Maryland Transportation Authority Police	Baltimore	MD	456	1	2.19	0.16
School District of Philadelphia Police	Philadelphia	PA	450	1	2.22	0.07
Washington Metropolitan Area Transit Auth. Police	District of Columbia	DC	442	2	4.52	0.33
California Dept. of Justice	Sacramento	CA	419	1	2.39	0.10
Ohio Dept of Natural Resources - Ofc. of Law Enf.	Franklin	OH	394	2	5.08	3.24
Los Angeles School Police Department	Los Angeles	CA	340	2	5.88	0.02
New York State Park Police	Albany	NY	305	1	3.28	0.21
Texas Alcoholic Beverage Commission	Travis	TX	277	1	3.61	0.10
MBTA Transit Police	Suffolk	MA	256	2	7.81	0.28
South Carolina Department of Natural Resources	Richland	SC	238	1	4.20	0.26
Mississippi Department of Wildlife, Fisheries & Parks	Hinds	MS	230	1	4.35	1.05
Maryland Natural Resources Police	Anne Arundel	MD	224	1	4.46	0.19
Metropolitan Washington Airports Authority Police	Arlington	VA	206	1	4.85	0.09
New Jersey Transit Police	Essex	NJ	201	3	14.93	0.47
BART Police Department	Alameda	CA	192	1	5.21	0.07
Palm Beach County School District Police	Palm Beach	FL	176	4	22.73	0.30
New York City Dept of Environmental Protection Police	Westchester	NY	168	1	5.95	1.29
Delaware River Port Authority - Transit Police	Camden	NJ	144	1	6.94	0.19
Baltimore City School Police Dept.	Baltimore City	MD	142	1	7.04	0.16
Maryland Transit Administration Police	Baltimore City	MD	140	1	7.14	0.16
Pennsylvania Dept of Conservation & Natural Resources	Dauphin	PA	136	1	7.35	0.79
South Carolina Dept of Mental Health-Public Safety	Richland	SC	120	1	8.33	0.26
San Antonio Park Rangers	Bexar	TX	112	3	26.79	0.17
New Mexico Department Of Game & Fish	Santa Fe	NM	106	1	9.43	0.69
Wisconsin Dept of Justice - Criminal Investigation Div.	Dane	WI	92	1	10.87	0.20
Vanderbilt University Police Department	Davidson	TN	91	1	10.99	0.16
New Jersey Department of Environmental Protection	Burlington	NJ	90	1	11.11	0.11
Dallas I.S.D. Police Dept.	Dallas	TX	88	1	11.36	0.04

Indiana State Excise Police	Marion	IN	88	1	11.36	0.11
Maryland National Capital Park Police - Montgomery Co	Montgomery	MD	86	1	11.63	0.41
University of Florida Police	Alachua	FL	85	1	11.76	0.40
Northside I.S.D. Police Dept.	Bexar	TX	83	2	24.10	0.12
Boston School Police	Suffolk	MA	80	1	12.50	0.14
Middlesex County Prosecutor's Office	Middlesex	NJ	80	1	12.50	0.12
University of Alabama - Birmingham Police Dept	Jefferson	AL	79	1	12.66	0.15
Virginia Commonwealth University Police Dept.	Richmond City	VA	74	2	27.03	0.98
California Bureau of Narcotics Enforcement	Sacramento	CA	73	2	27.40	0.02
University of Pittsburgh - Main Campus Police	Allegheny	PA	73	1	13.70	0.08
Austin I.S.D. Police Department	Travis	TX	70	1	14.29	0.10
Georgia State University Police	Fulton	GA	68	1	14.71	0.11
Maryland Department of General Services Police	Baltimore City	MD	68	1	14.71	0.16
Anchorage International Airport Police	Anchorage	AK	65	1	15.38	0.34
Louisiana State University Police Department	East Baton Rouge	LA	62	1	16.13	0.23
Medical University of South Carolina Public Safety	Charleston	SC	62	1	16.13	0.29
University of Texas - Austin Police	Travis	TX	62	1	16.13	0.10
Duke University Police Department	Durham	NC	60	1	16.67	0.37
Virginia Marine Resources Commission	Newport News City	VA	60	1	16.67	3.02
Volusia County Beach Patrol	Volusia	FL	60	2	33.33	0.40
MIT Police Department	Middlesex	MA	59	1	16.95	0.07
Northern Illinois University Police	DeKalb	IL	59	1	16.95	0.95
University of California - Los Angeles Police	Los Angeles	CA	57	1	17.54	0.01
University of Illinois Police Dept	Champaign	IL	54	1	18.52	0.50
George Mason University Police Dept.	Fairfax	VA	52	1	19.23	0.09
University of Tennessee at Knoxville Police	Knox	TN	52	2	38.46	10.47
Ohio State University Police Department	Franklin	OH	51	1	19.61	0.09
United I.S.D. Police Dept.	Webb	TX	51	1	19.61	0.40
Delaware River & Bay Authority Police	New Castle	DE	50	1	20.00	0.51
Louisiana State Univ. Health Sciences Center Police Dept	Caddo	LA	49	1	20.41	0.39
Wayne State University Dept of Public Safety	Wayne	MI	49	1	20.41	0.05
Houston Community College System	Harris	TX	48	1	20.83	0.02
McAllen I.S.D. Police Dept.	Hidalgo	TX	43	1	23.26	0.13
Southern University and A & M College Police	East Baton Rouge	LA	43	1	23.26	0.23
Allegheny Port Authority Transit Police	Allegheny	PA	42	1	23.81	0.08
State University at Albany Police	Albany	NY	41	1	24.39	0.33

Massachusetts Dept of Mental Health Police Dept	Suffolk	MA	40	2	50.00	0.28
University of North Texas Police Department	Denton	TX	40	1	25.00	0.15
Florida Atlantic University Police	Palm Beach	FL	39	1	25.64	0.08
Florida International University Police	Miami-Dade	FL	39	1	25.64	0.04
Kansas State Law Enforcement Training Center	Reno	KS	39	1	25.64	0.20
University of Arkansas Medical Sciences Dept of Pub	Pulaski	AR	36	1	27.78	0.26
Tuskegee University Police Department	Macon	AL	33	1	30.30	4.66
Medical College of Georgia	Richmond	GA	32	1	31.25	0.50
Buffalo State College Police	Erie	NY	30	1	33.33	0.11
Cameron Co. District Attorney Investigations Div	Cameron	TX	30	1	33.33	0.25
Houston Baptist University Police Department	Harris	TX	30	1	33.33	0.02
Kentucky Alcoholic Beverage Control	Franklin	KY	30	2	66.67	0.27
Ohio Department of Taxation - Enforcement Division	Franklin	OH	30	1	33.33	0.18
Socorro I.S.D. Police Dept.	El Paso	TX	30	1	33.33	0.12
Dayton International Airport Police Dept	Montgomery	OH	29	1	34.48	0.19
Tennessee State University	Davidson	TN	27	2	74.07	0.32
Appalachian State University Police Dept	Watauga	NC	25	1	40.00	1.96
Humble I.S.D. Police Dept.	Harris	TX	24	1	41.67	0.02
Beaumont I.S.D. Police Dept.	Jefferson	TX	22	1	45.45	0.40
Central Michigan University Police Department	Isabella	MI	21	1	47.62	1.42
North Forest I.S.D. Police Dept.	Harris	TX	21	1	47.62	0.02
Santa Ana Unified School District Police Dept.	Orange	CA	21	2	95.24	0.07
St. Mary's University Police Department	Bexar	TX	20	1	50.00	0.06
Georgia Public Safety Training Center	Monroe	GA	19	1	52.63	3.78
Indiana University Purdue U. Fort Wayne U. Police	Allen	IN	18	1	55.56	0.28
Lafayette College Office of Public Safety	Northampton	PA	18	1	55.56	0.34
Arkansas State University Police Dept.	Craighead	AR	17	1	58.82	1.04
Shippensburg University of Pennsylvania Police	Cumberland	PA	17	1	58.82	0.42
St. Joseph County Airport Police	St. Joseph	IN	17	1	58.82	0.37
Bowie State University Dept. of Public Safety	Prince Georges	MD	14	1	71.43	0.12
St. Edward's University Police Department	Travis	TX	14	1	71.43	0.10
University of Colorado - Colorado Springs Police Dept.	El Paso	CO	14	1	71.43	0.16
College of Lake County Police Dept	Lake	IL	13	1	76.92	0.14
Missouri Department of Corrections	Cole	MO	13	1	76.92	1.32
University of Pittsburgh at Johnstown Police	Cambria	PA	13	1	76.92	0.70
University of South Carolina - Upstate Police Dept	Spartanburg	SC	12	1	83.33	0.35

Midland I.S.D. Police Dept.	Midland	TX	11	1	90.91	0.73
Missouri Univ. of Science & Technology Police Dept	Phelps	MO	11	1	90.91	2.21
Morrisville State College Police	Madison	NY	11	1	90.91	1.36
BYU-Idaho Police Department	Madison	ID	10	1	100.00	2.66
Lander University Public Safety	Greenwood	SC	10	1	100.00	1.44
Grambling State University Police Dept.	Lincoln	LA	9	2	222.22	4.28
Greenville Technical College Public Safety	Greenville	SC	9	1	111.11	0.22
Lehigh-Northampton Airport Auth. Police Dept	Lehigh	PA	9	1	111.11	0.29
California Exposition And State Fair Police	Sacramento	CA	6	1	166.67	0.07
Lancaster I.S.D. Police Dept.	Dallas	TX	6	1	166.67	0.04
University of Maryland Eastern Shore Public Safety	Somerset	MD	6	1	166.67	3.78
University of West Alabama Police	Sumter	AL	6	1	166.67	7.27
Ennis I.S.D. Police Department	Ellis	TX	5	1	200.00	0.67
Ventura College	Ventura	CA	5	1	200.00	0.12
Connally I.S.D. Police Dept.	McLennan	TX	3	1	333.33	0.43
Santa Rosa I.S.D. Police Department	Cameron	TX	3	1	333.33	0.25

Appendix B-1. 200 Largest State & Local Law Enforcement Agencies in Study: Rates of Officers Arrested, 2005-2011 (Sorted by Rate per 1,000 Officers)

Agency	County	State	# of Full-Time Sworn Personnel	Per Agency	Per 1,000 Officers	Per 100,000 Population
New Orleans Police Department	Orleans	LA	1425	63	44.21	18.32
Milwaukee Police Department	Milwaukee	WI	1987	73	36.74	7.70
Memphis Police Department	Shelby	TN	1549	46	29.70	4.96
New Mexico State Police	Santa Fe	NM	528	13	24.62	0.63
Pittsburgh Police Department	Allegheny	PA	891	21	23.57	1.72
Shreveport Police Department	Caddo	LA	511	12	23.48	4.71
Polk County Sheriff's Office	Polk	FL	600	13	21.67	2.16
Kern County Sheriff's Office	Kern	CA	512	11	21.48	1.31
Indianapolis Police	Marion	IN	1582	33	20.86	3.65
Minneapolis Police Department	Hennepin	MN	902	18	19.96	1.56
Springfield Police Department	Hampden	MA	464	9	19.40	1.94
Toledo Police Department	Lucas	OH	640	12	18.75	2.72
Jackson Police Department	Hinds	MS	480	9	18.75	3.67
Baltimore Police Department	Baltimore City	MD	2990	55	18.39	8.86
Durham Police Department	Durham	NC	494	9	18.22	3.36
Norfolk Police Department	Norfolk City	VA	772	14	18.13	5.77
Akron Police Department	Summit	OH	472	8	16.95	1.48
Cleveland Police Department	Cuyahoga	OH	1616	27	16.71	2.11
Shelby County Sheriff's Office	Shelby	TN	516	8	15.50	0.86
San Antonio Police Department	Bexar	TX	2020	30	14.85	1.75
Jefferson Parish Sheriff's Office	Jefferson	LA	825	12	14.55	2.77
Providence Police Department	Providence	RI	483	7	14.49	1.12
Nashville Metro Police Department	Davidson	TN	1315	18	13.69	2.87
Honolulu (City & County) Police Department	Honolulu	HI	1934	26	13.44	2.73
Fort Worth Police Department	Tarrant	TX	1489	20	13.43	1.11
St. Paul Police Department	Ramsey	MN	598	8	13.38	1.57
Louisville Metro Police Department	Jefferson	KY	1197	16	13.37	2.16
Milwaukee County Sheriff's Office	Milwaukee	WI	524	7	13.36	0.74
Jersey City Police	Hudson	NJ	900	12	13.33	1.89
Tulsa Police Department	Tulsa	OK	826	11	13.32	1.82
Montgomery County Police Department	Montgomery	MD	1206	16	13.27	1.65
El Paso Police Department	El Paso	TX	1132	15	13.25	1.87

Atlanta Police Department	Fulton	GA	1719	22	12.80	2.39
Albuquerque Police Department	Bernalillo	NM	1020	13	12.75	1.96
Miami Police Department	Miami-Dade	FL	1104	14	12.68	0.56
Fort Lauderdale Police Department	Broward	FL	482	6	12.45	0.34
DeKalb County Police Department	DeKalb	GA	1074	13	12.10	1.88
Prince George's County Police Department	Prince Georges	MD	1578	19	12.04	2.20
Montgomery Police Department	Montgomery	AL	500	6	12.00	2.62
Charlotte - Mecklenburg Police Department	Mecklenburg	NC	1672	20	11.96	2.17
St. Petersburg Police Department	Pinellas	FL	510	6	11.76	0.65
Dallas Police Department	Dallas	TX	3389	39	11.51	1.65
Oklahoma City Police Department	Oklahoma	OK	1046	12	11.47	1.67
Orange County Sheriff's Office	Orange	FL	1398	16	11.44	1.40
Raleigh Police Department	Wake	NC	702	8	11.40	0.89
Passaic County Sheriff's Office	Passaic	NJ	530	6	11.32	1.20
Lee County Sheriff's Office	Lee	FL	621	7	11.27	1.13
Savannah-Chatham Metropolitan Police Dept	Chatham	GA	534	6	11.24	2.26
Richmond County Sheriff's Office	Richmond	GA	449	5	11.14	2.49
Virginia Beach Police Department	VA Beach City	VA	813	9	11.07	2.05
Portland Police Bureau	Multnomah	OR	928	10	10.78	1.36
Orlando Police Department	Orange	FL	757	8	10.57	0.70
Worcester Police Department	Worcester	MA	482	5	10.37	0.63
South Carolina Highway Patrol	Richland	SC	967	10	10.34	0.22
Detroit Police Department	Wayne	MI	2250	23	10.22	1.26
Mississippi Highway Safety Patrol	Hinds	MS	594	6	10.10	0.20
Philadelphia Police Department	Philadelphia	PA	6624	66	9.96	4.33
Broward County Sheriff's Office	Broward	FL	1624	16	9.85	0.92
Birmingham Police Department	Jefferson	AL	816	8	9.80	1.21
Aurora Police Department	Arapahoe	CO	627	6	9.57	1.05
Collier County Sheriff's Office	Collier	FL	628	6	9.55	1.87
Baton Rouge Police Department	E. Baton Rouge	LA	630	6	9.52	1.36
Bexar County Sheriff's Office	Bexar	TX	526	5	9.51	0.29
Marion County Sheriff's Office	Marion	IN	740	7	9.46	0.77
Richmond Police Department	Richmond City	VA	752	7	9.31	3.43
Pinellas County Sheriff's Office	Pinellas	FL	863	8	9.27	0.87
Cincinnati Police Department	Hamilton	OH	1082	10	9.24	1.25
Fort Wayne Police	Allen	IN	447	4	8.95	1.13

Volusia County Sheriff's Office	Volusia	FL	450	4	8.89	0.81
Florida Highway Patrol	Leon	FL	1606	14	8.72	0.07
Denver Police Department	Denver	CO	1525	13	8.52	2.17
Cobb County Police Department	Cobb	GA	590	5	8.47	0.73
Fresno Police Department	Fresno	CA	828	7	8.45	0.75
Greensboro Police Department	Guilford	NC	593	5	8.43	1.02
Manatee County Sheriff's Office	Manatee	FL	476	4	8.40	1.24
Palm Beach County Sheriff's Office	Palm Beach	FL	1447	12	8.29	0.91
Pasco County Sheriff's Office	Pasco	FL	485	4	8.25	0.86
Hillsborough County Sheriff's Office	Hillsborough	FL	1223	10	8.18	0.81
Miami-Dade (County) Police Department	Miami-Dade	FL	3093	25	8.08	1.00
Omaha Police Dept	Douglas	NE	747	6	8.03	1.16
Orleans Parish Sheriff's Office (Criminal Division)	Orleans	LA	505	4	7.92	1.16
Orange County Sheriff-Coroner Department	Orange	CA	1794	14	7.80	0.47
Mobile Police Department	Mobile	AL	515	4	7.77	0.97
Washington Metropolitan Police Department	DC	DC	3742	29	7.75	4.82
Fulton County Sheriff's Office	Fulton	GA	516	4	7.75	0.43
Minnesota State Patrol	Ramsey	MN	530	4	7.55	0.08
Colorado Springs Police Department	El Paso	CO	668	5	7.49	0.80
St. Louis (city) Police Dept	St. Louis City	MO	1351	10	7.40	3.13
Jacksonville Sheriff's Office	Duval	FL	1662	12	7.22	1.39
Henrico County Division of Police	Henrico	VA	554	4	7.22	1.30
Sacramento Police Department	Sacramento	CA	701	5	7.13	0.35
Seattle Police Department	King	WA	1283	9	7.01	0.47
Houston Police Department	Harris	TX	5053	35	6.93	0.86
King County Sheriff's Office	King	WA	721	5	6.93	0.26
Denver County Sheriff's Office	Denver	CO	739	5	6.77	0.83
Leon County Sheriff's Office	Leon	FL	443	3	6.77	1.09
Corpus Christi Police Department	Nueces	TX	448	3	6.70	0.88
Austin Police Department	Travis	TX	1515	10	6.60	0.98
San Jose Police Department	Santa Clara	CA	1382	9	6.51	0.51
Boston Police Department	Suffolk	MA	2181	14	6.42	1.94
Florida Fish & Wildlife Conservation Commission	Leon	FL	626	4	6.39	0.02
Maryland State Police	Baltimore	MD	1440	9	6.25	0.16
Chicago Police Department	Cook	IL	13354	83	6.22	1.60
San Diego Police Department	San Diego	CA	1951	12	6.15	0.39

Syracuse Police Department	Onondaga	NY	489	3	6.13	0.64
San Bernardino County Sheriff's Office	San Bernardino	CA	1797	11	6.12	0.54
Newark Police	Essex	NJ	1310	8	6.11	1.02
Oklahoma Department of Public Safety	Oklahoma	OK	825	5	6.06	0.13
Paterson Police	Passaic	NJ	497	3	6.04	0.60
Fairfax County Sheriff's Office	Fairfax	VA	499	3	6.01	0.28
Winston-Salem Police Department	Forsyth	NC	508	3	5.91	0.86
Gwinnett County Police Department	Gwinnett	GA	682	4	5.87	0.50
Richland County Sheriff's Office	Richland	SC	512	3	5.86	0.78
Tulare County Sheriff's Office	Tulare	CA	513	3	5.85	0.68
Pennsylvania State Police	Dauphin	PA	4458	26	5.83	0.20
Tucson Police Department	Pima	AZ	1032	6	5.81	0.61
Gwinnett County Sheriff's Office	Gwinnett	GA	531	3	5.65	0.37
Prince William County Police Department	Prince William	VA	546	3	5.49	0.75
New York City Police Department	New York	NY	36023	196	5.44	2.40
Colorado State Patrol	Jefferson	CO	742	4	5.39	0.08
San Diego County Sheriff's Office	San Diego	CA	1322	7	5.30	0.23
Michigan State Police	Ingham	MI	1732	9	5.20	0.09
Riverside County Sheriff's Office	Riverside	CA	2147	11	5.12	0.50
Buffalo Police Department	Erie	NY	793	4	5.04	0.44
Phoenix Police Department	Maricopa	AZ	3388	17	5.02	0.45
Fairfax County Police Department	Fairfax	VA	1419	7	4.93	0.65
Arlington Police Department	Tarrant	TX	610	3	4.92	0.17
Columbus Police Department	Franklin	OH	1886	9	4.77	0.77
Illinois State Police	Sangamon	IL	2105	10	4.75	0.08
Anne Arundel County Police Department	Anne Arundel	MD	633	3	4.74	0.56
Delaware State Police	Kent	DE	658	3	4.56	0.33
Washington Metro Area Transit Auth. Police	DC	DC	442	2	4.52	0.33
Loudoun County Sheriff's Office	Loudoun	VA	448	2	4.46	0.64
Dane County Sheriff's Office	Dane	WI	454	2	4.41	0.41
Franklin County Sheriff's Office	Franklin	OH	455	2	4.40	0.17
North Carolina State Highway Patrol	Wake	NC	1827	8	4.38	0.08
Massachusetts State Police	Middlesex	MA	2310	10	4.33	0.15
Rochester Police Department	Monroe	NY	703	3	4.27	0.40
New Jersey State Police	Mercer	NJ	3053	13	4.26	0.15
Sacramento County Sheriff's Office	Sacramento	CA	1409	6	4.26	0.42

Tennessee Department of Safety	Davidson	TN	942	4	4.25	0.06
North Las Vegas Police Department	Clark	NV	471	2	4.25	0.10
Utah Department of Public Safety	Salt Lake	UT	475	2	4.21	0.07
Long Beach Police Department	Los Angeles	CA	968	4	4.13	0.04
Brevard County Sheriff's Office	Brevard	FL	497	2	4.02	0.37
Oakland Police Department	Alameda	CA	773	3	3.88	0.20
Little Rock Police Department	Pulaski	AR	520	2	3.85	0.52
Arkansas State Police	Pulaski	AR	525	2	3.81	0.07
San Francisco Police Department	San Francisco	CA	1940	7	3.61	0.87
Kansas City Police Department	Jackson	MO	1421	5	3.52	0.74
Kentucky State Police	Franklin	KY	882	3	3.40	0.07
Connecticut State Police	Middlesex	CT	1227	4	3.26	0.11
Yonkers Police Department	Westchester	NY	641	2	3.12	0.21
Los Angeles Police Department	Los Angeles	CA	9727	30	3.08	0.31
Tampa Police Department	Hillsborough	FL	980	3	3.06	0.24
Indiana State Police	Marion	IN	1315	4	3.04	0.06
Wichita Police Department	Sedgwick	KS	662	2	3.02	0.40
Iowa Department of Public Safety	Polk	IA	669	2	2.99	0.07
New York State Metro Transportation Auth. Police	New York	NY	694	2	2.88	0.02
Las Vegas Metro Police Department	Clark	NV	2942	8	2.72	0.41
Alabama Department of Public Safety	Montgomery	AL	763	2	2.62	0.04
Maricopa County Sheriff's Office	Maricopa	AZ	766	2	2.61	0.05
Ohio State Highway Patrol	Franklin	OH	1560	4	2.56	0.03
St. Louis County Police Dept	St. Louis	MO	781	2	2.56	0.20
Arizona Department of Public Safety	Maricopa	AZ	1244	3	2.41	0.05
Mesa Police Department	Maricopa	AZ	831	2	2.41	0.05
Suffolk County Police Department	Suffolk	NY	2622	6	2.29	0.40
Madison Police Department	Dane	WI	437	1	2.29	0.20
Will County Sheriff's Office	Will	IL	445	1	2.25	0.15
Dallas County Sheriff's Office	Dallas	TX	449	1	2.23	0.04
Santa Clara County Sheriff's Office	Santa Clara	CA	450	1	2.22	0.06
School District of Philadelphia Police	Philadelphia	PA	450	1	2.22	0.07
Nassau County Police Department	Nassau	NY	2732	6	2.20	0.45
El Paso County Sheriff's Office	El Paso	CO	454	1	2.20	0.16
Knox County Sheriff's Office	Knox	TN	456	1	2.19	0.23
Maryland Transportation Authority Police	Baltimore	MD	456	1	2.19	0.02

Fresno County Sheriff's Office	Fresno	CA	461	1	2.17	0.11
Alameda County Sheriff's Office	Alameda	CA	928	2	2.16	0.13
Chesterfield County Police Department	Chesterfield	VA	475	1	2.11	0.32
Baltimore County Police Department	Baltimore	MD	1910	4	2.09	0.50
District of Columbia Protective Services Police	DC	DC	484	1	2.07	0.17
Nebraska State Patrol	Lancaster	NE	491	1	2.04	0.05
Monmouth County Sheriff's Office	Monmouth	NJ	494	1	2.02	0.16
California Highway Patrol	Sacramento	CA	7202	13	1.81	0.03
Pima County Sheriff's Dept.	Pima	AZ	554	1	1.81	0.10
Washington State Patrol	Thurston	WA	1132	2	1.77	0.03
Texas Department of Public Safety	Travis	TX	3529	6	1.70	0.02
Calcasieu Parish Sheriff's Office	Calcasieu	LA	592	1	1.69	0.52
Louisiana State Police	E. Baton Rouge	LA	1215	2	1.65	0.04
Virginia State Police	Chesterfield	VA	1873	3	1.60	0.04
Los Angeles County Sheriff's Office	Los Angeles	CA	9461	14	1.48	0.14
Contra Costa County Sheriff's Office	Contra Costa	CA	679	1	1.47	0.10
Cook County Sheriff's Office	Cook	IL	5655	8	1.41	0.15
Ventura County Sheriff's Office	Ventura	CA	755	1	1.32	0.12
Harris County Sheriff's Office	Harris	TX	2558	3	1.17	0.07
New York State Police	Albany	NY	4847	5	1.03	0.03
Georgia Department of Public Safety	Fulton	GA	1048	1	0.95	0.01
Wayne County Sheriff's Office	Wayne	MI	1062	1	0.94	0.05
Port Authority of New York & New Jersey Police	Hudson	NJ	1667	1	0.60	0.01
New York State Courts Officers	New York	NY	4500	1	0.22	0.01

Appendix B-2. Nonmetropolitan State & Local Law Enforcement Agencies in Study: Rates of Officers Arrested, 2005-2011 (Sorted by Rate per 1,000 Officers)

Agency	County	State	# of Full-Time Sworn Personnel	Per Agency	Per 1,000 Officers	Per 100,000 Population
Mounds Police Dept	Pulaski	IL	1	2	2000.00	32.46
Atwater Police Department	Kandiyohi	MN	1	1	1000.00	2.37
Berlin Borough Police Department	Somerset	PA	1	1	1000.00	1.29
Berlin Heights Police Department	Erie	OH	1	1	1000.00	1.30
Bowman Police Department	Orangeburg	SC	3	3	1000.00	3.24
Burr Oak Police Department	St. Joseph	MI	1	1	1000.00	1.63
Cooter Police Department	Pemiscot	MO	1	1	1000.00	5.47
Elgin Police Department	Grant	ND	1	1	1000.00	41.77
Hamburg Police Department	Fremont	IA	1	1	1000.00	13.44
Lamoure Police Department	LaMoure	ND	1	1	1000.00	24.16
Lockhart Police Department	Covington	AL	1	1	1000.00	2.65
Marion Township Police Department	Waushara	WI	1	1	1000.00	4.08
Nicholas County Sheriff's Office	Nicholas	KY	1	1	1000.00	14.02
Oakwood Police Department	Paulding	OH	1	1	1000.00	5.10
Perryville Police Department	Boyle	KY	1	1	1000.00	3.52
Petroleum County Sheriff's Office	Petroleum	MT	1	1	1000.00	202.43
Pineview Police Department	Wilcox	GA	1	1	1000.00	10.80
Tipton Police Department	Tillman	OK	1	1	1000.00	12.51
Turkey Creek Police Department	Evangeline	LA	1	1	1000.00	2.94
Wakeman Police Department	Huron	OH	1	1	1000.00	1.68
Wilson Police Department	Ellsworth	KS	1	1	1000.00	15.39
Zolfo Springs Police Department	Hardee	FL	1	1	1000.00	3.61
Carter County Sheriff's Office	Carter	MO	3	2	666.67	31.92
Chilhowie Police Department	Smyth	VA	6	4	666.67	12.42
Shenandoah Borough Police Department	Schuylkill	PA	7	4	571.43	2.70
Athena Police Department	Umatilla	OR	2	1	500.00	1.32
Birchwood Police Department	Washburn	WI	2	1	500.00	6.28
Boswell Police Department	Choctaw	OK	2	1	500.00	6.58
Cherokee Police Department	Alfalfa	OK	2	1	500.00	17.72
Franklin Police Dept	Franklin	NE	2	1	500.00	31.01
Hegins Township Police Department	Schuylkill	PA	2	1	500.00	0.67

Homer City Borough Police Department	Indiana	PA	2	1	500.00	1.13
Hunter Police Department	Greene	NY	2	1	500.00	2.03
Inman Police Department	McPherson	KS	2	1	500.00	3.43
Meyersdale Borough Police Department	Somerset	PA	2	1	500.00	1.29
Pineland Police Department	Sabine	TX	2	1	500.00	9.23
Pink Hill Police Department	Lenoir	NC	2	1	500.00	1.68
Ridgeville Police	Randolph	IN	2	1	500.00	3.82
Ridgeville Police Department	Dorchester	SC	2	1	500.00	2.57
Seadrift Police Department	Calhoun	TX	2	1	500.00	4.68
Springfield Police Department	Orangeburg	SC	2	1	500.00	1.08
White Cloud Police Department	Newaygo	MI	2	1	500.00	2.06
Windber Borough Police Department	Somerset	PA	2	1	500.00	1.29
Oregon County Sheriff's Office	Oregon	MO	5	2	400.00	18.38
Roseboro Police Department	Sampson	NC	5	2	400.00	3.15
Talbot County Sheriff's Office	Talbot	GA	8	3	375.00	43.70
Crystal City Police Department	Zavala	TX	11	4	363.64	34.26
Belle Police Department	Maries	MO	3	1	333.33	10.90
Bismarck Police Department	St. Francois	MO	3	1	333.33	1.53
Butler County Sheriff's Office	Butler	AL	9	3	333.33	14.32
Caddo Police Department	Bryan	OK	3	1	333.33	2.36
Earlville Police Dept	La Salle	IL	3	1	333.33	0.88
Fair Bluff Police Department	Columbus	NC	3	1	333.33	1.72
Freedom Police Department	Carroll	NH	3	1	333.33	2.09
Gallatin County Sheriff's Office	Gallatin	IL	3	1	333.33	17.89
Griggs County Sheriff's Office	Griggs	ND	3	1	333.33	41.32
Guadalupe County Sheriff's Office	Guadalupe	NM	3	1	333.33	21.34
Haskell Police Department	Haskell	TX	3	1	333.33	16.95
Hennessey Police Department	Kingfisher	OK	3	1	333.33	6.65
Kahoka Police Department	Clark	MO	3	1	333.33	6.58
Marvell Police Department	Phillips	AR	3	1	333.33	4.60
Meigs Police Department	Thomas	GA	3	1	333.33	2.24
Newbury Police Department	Merrimack	NH	3	1	333.33	0.68
Ravenna Police Dept	Buffalo	NE	3	1	333.33	2.17
Santee Police Department	Orangeburg	SC	6	2	333.33	2.16
Scotts Hill Police Department	Henderson	TN	3	1	333.33	3.60
Stover Police Department	Morgan	MO	3	1	333.33	4.86

Waukomis Police Department	Garfield	OK	3	1	333.33	1.65
La Salle County Sheriff's Office	La Salle	TX	10	3	300.00	43.57
Shelby Police Department	Bolivar	MS	7	2	285.71	5.86
Shinnston Police Department	Harrison	WV	7	2	285.71	2.89
Seneca County Sheriff's Office	Seneca	NY	23	6	260.87	17.02
Blue Lake Police Department	Humboldt	CA	4	1	250.00	0.74
Butler Township Police Department	Schuylkill	PA	4	1	250.00	0.67
Columbus Police Department	Luna	NM	4	1	250.00	3.98
Delhi Village Police Department	Delaware	NY	4	1	250.00	2.08
Edenton Police Department	Chowan	NC	12	3	250.00	20.28
Elmore Police Department	Ottawa	OH	4	1	250.00	2.41
Fairland Police Department	Ottawa	OK	4	1	250.00	3.14
Foster Township Police Department	McKean	PA	4	1	250.00	2.30
Gold Beach Police Department	Curry	OR	4	1	250.00	4.47
Hemingway Police Department	Williamsburg	SC	4	1	250.00	2.91
Keokuk County Sheriff's Office	Keokuk	IA	4	1	250.00	9.51
Mahanoy City Borough Police Department	Schuylkill	PA	4	1	250.00	0.67
Malakoff Police Department	Henderson	TX	4	1	250.00	1.27
Marble Head Police Department	Ottawa	OH	4	1	250.00	2.41
Marshallville Police Dept.	Macon	GA	4	1	250.00	6.78
McArthur Police Department	Vinton	OH	4	1	250.00	7.44
Monroeville Police Department	Huron	OH	4	1	250.00	1.68
New Lisbon Police Department	Juneau	WI	4	1	250.00	3.75
Onley Police Department	Accomack	VA	4	1	250.00	3.02
Rochelle Police Department	Wilcox	GA	4	1	250.00	10.80
Roodhouse Police Dept	Greene	IL	4	1	250.00	7.20
Tutwiler Police Department	Tallahatchie	MS	4	1	250.00	6.50
Winsted Police Department	Litchfield	CT	4	1	250.00	0.53
Grambling State University Police Dept.	Lincoln	LA	9	2	222.22	4.28
Lake County Sheriff's Office	Lake	CO	9	2	222.22	27.36
Tabor City Police Department	Columbus	NC	9	2	222.22	3.44
Cochran Police Department	Bleckley	GA	14	3	214.29	22.97
Jackson County Sheriff's Office	Jackson	TN	14	3	214.29	25.78
Allendale Police Department	Allendale	SC	10	2	200.00	19.20
Carlisle Police Department	Nicholas	KY	5	1	200.00	14.02
Chaffee Police Department	Scott	MO	5	1	200.00	2.55

Commerce Police Department	Ottawa	OK	5	1	200.00	3.14
Crescent City Police Department	Putnam	FL	5	1	200.00	1.34
Creston Police Department	Union	IA	10	2	200.00	15.96
Delhi Police Department	Richland	LA	5	1	200.00	4.83
Dixon Police Department	Pulaski	MO	5	1	200.00	1.91
Durand Police Department	Shiawassee	MI	5	1	200.00	1.42
Estill County Sheriff's Office	Estill	KY	5	1	200.00	6.82
Fryeburg Police Department	Oxford	ME	5	1	200.00	1.73
Grand Rapids Police Department	Wood	WI	5	1	200.00	1.34
Grant County Sheriff's Office	Grant	OK	5	1	200.00	22.09
Haskell Police Department	Muskogee	OK	5	1	200.00	1.41
Holt County Sheriff's Office	Holt	NE	5	1	200.00	9.58
Kenton Police Department	Obion	TN	5	1	200.00	3.14
Lake County Sheriff's Office	Lake	SD	5	1	200.00	8.93
Level Plains Police Department	Dale	AL	5	1	200.00	1.99
Lewis County Sheriff's Office	Lewis	MO	5	1	200.00	9.79
Middletown Police	Henry	IN	5	1	200.00	2.02
Montpelier Police Department	Bear Lake	ID	5	1	200.00	16.71
Mora County Sheriff's Office	Mora	NM	5	1	200.00	20.49
North Kingsville Police Department	Ashtabula	OH	5	1	200.00	0.99
Oglethorpe Police Department	Macon	GA	5	1	200.00	6.78
Olney Police Department	Young	TX	5	1	200.00	5.39
Pearson Police Department	Atkinson	GA	5	1	200.00	11.94
Pocahontas County Sheriff's Office	Pocahontas	WV	5	1	200.00	11.47
Ranger Police Department	Eastland	TX	5	1	200.00	5.38
Richland Police Dept	Pulaski	MO	5	1	200.00	1.91
Robbins Police Department	Moore	NC	5	1	200.00	1.13
Rosedale Police Department	Bolivar	MS	5	1	200.00	2.93
Santa Clara Police Department	Grant	NM	5	1	200.00	3.39
Sugarcreek Borough Police Department	Venango	PA	5	1	200.00	1.82
Sugarcreek Police Department	Tuscarawas	OH	5	1	200.00	1.08
Terrell County Sheriff's Office	Terrell	TX	5	1	200.00	101.63
Vergennes Police Department	Addison	VT	5	1	200.00	2.72
West Yellowstone Police Department	Gallatin	MT	5	1	200.00	1.12
Woodstock Police Department	Grafton	NH	5	1	200.00	1.12
Hockley County Sheriff's Office	Hockley	TX	11	2	181.82	8.72

Montezuma Police Department	Macon	GA	11	2	181.82	13.57
Pulaski County Sheriff's Office	Pulaski	IL	11	2	181.82	32.46
Stephens County Sheriff's Office	Stephens	OK	11	2	181.82	4.44
Bingen-White Salmon Police Department	Klickitat	WA	6	1	166.67	4.92
Bridgeport Police Department	Jackson	AL	6	1	166.67	1.88
Columbus Police Department	Polk	NC	6	1	166.67	4.88
East Brewton Police Department	Escambia	AL	6	1	166.67	2.61
Fairfax Police Department	Allendale	SC	6	1	166.67	9.60
Florala Police Department	Covington	AL	6	1	166.67	2.65
Geneva Township Police Department	Walworth	WI	6	1	166.67	0.98
Kaw Nation Tribal Police	Kay	OK	6	1	166.67	2.15
Norton Police Department	Norton	KS	6	1	166.67	17.63
Sleepy Eye Police Department	Redwood	MN	6	1	166.67	3.86
St. Paul Police Department	Wise	VA	6	1	166.67	2.41
University of West Alabama Police	Sumter	AL	6	1	166.67	7.27
Woodruff County Sheriff's Office	Woodruff	AR	6	1	166.67	13.77
Eunice Police Department	St. Landry	LA	32	5	156.25	6.00
Black River Falls Police Department	Jackson	WI	7	1	142.86	4.89
Byron Police Dept	Ogle	IL	7	1	142.86	1.87
Clay County Sheriff's Office	Clay	AR	7	1	142.86	6.22
Coeburn Police Department	Wise	VA	7	1	142.86	2.41
Flemingsburg Police Department	Fleming	KY	7	1	142.86	6.97
Fremont County Sheriff's Office	Fremont	IA	7	1	142.86	13.44
Haynesville Police Dept	Claiborne	LA	7	1	142.86	5.82
Hermann Police Department	Gasconade	MO	7	1	142.86	6.57
Holly Hill Police Department	Orangeburg	SC	7	1	142.86	1.08
Mason County Sheriff's Office	Mason	WV	21	3	142.86	10.98
Murphy Police Department	Cherokee	NC	7	1	142.86	3.64
New Castle Police Department	Garfield	CO	7	1	142.86	1.77
Port Barre Police Dept	St. Landry	LA	7	1	142.86	1.20
Providence Police Department	Webster	KY	7	1	142.86	7.34
Union Police Department	Newton	MS	7	1	142.86	4.60
Winnsboro Police Department	Franklin	LA	7	1	142.86	4.82
Yemassee Police Department	Hampton	SC	7	1	142.86	4.74
Fayette County Sheriff's Office	Fayette	OH	22	3	136.36	10.33
Helena\West Helena Police Department	Phillips	AR	30	4	133.33	18.38

Nebraska City Police Dept	Otoe	NE	15	2	133.33	12.71
Shelby County Sheriff's Office	Shelby	TX	15	2	133.33	7.86
Big Horn County Sheriff's Office	Big Horn	MT	8	1	125.00	7.77
Blackford County Sheriff's Office	Blackford	IN	8	1	125.00	7.83
Blountstown Police Dept.	Calhoun	FL	8	1	125.00	6.84
Canton Village Police Department	St. Lawrence	NY	8	1	125.00	0.89
Chandler Police Department	Henderson	TX	8	1	125.00	1.27
Eunice Police Department	Lea	NM	8	1	125.00	1.54
Henry County Sheriff's Office	Henry	VA	112	14	125.00	25.85
Kingfisher County Sheriff's Office	Kingfisher	OK	8	1	125.00	6.65
Madison County Sheriff's Office	Madison	MO	8	1	125.00	8.18
Oglesby Police Dept	La Salle	IL	8	1	125.00	0.88
Waynesburg Borough Police Department	Greene	PA	8	1	125.00	2.58
Whiteville Police Department	Hardeman	TN	8	1	125.00	3.67
McIntosh County Sheriff's Office	McIntosh	OK	17	2	117.65	9.88
Princeton Police Department	Mercer	WV	17	2	117.65	3.21
Andrews Police Department	Georgetown	SC	9	1	111.11	1.66
Arcade Police Department	Jackson	GA	9	1	111.11	1.65
Beardstown Police Dept	Cass	IL	9	1	111.11	7.33
Belpre Police Department	Washington	OH	9	1	111.11	1.62
Dillon Police Department	Summit	CO	9	1	111.11	3.57
Forest City Police Department	Winnebago	IA	9	1	111.11	9.20
Forks Police Department	Clallam	WA	9	1	111.11	1.40
Glendive Police Department	Dawson	MT	9	1	111.11	11.15
Hanceville Police Department	Cullman	AL	9	1	111.11	1.24
Lawrence Township Police Department	Clearfield	PA	9	1	111.11	1.22
Minocqua Police Department	Oneida	WI	9	1	111.11	2.78
Osceola Police Department	Clarke	IA	9	1	111.11	10.77
Ripley Police Department	Jackson	WV	9	1	111.11	3.42
Allenstown Police Department	Merrimack	NH	10	1	100.00	0.68
Alma Police Department	Bacon	GA	10	1	100.00	9.01
BYU-Idaho Police Department	Madison	ID	10	1	100.00	2.66
Clewiston Police Department	Hendry	FL	20	2	100.00	5.11
Columbus Police Department	Colorado	TX	10	1	100.00	4.79
Dewitt Police Department	Clinton	IA	10	1	100.00	2.04
Ferriday Police Department	Concordia	LA	10	1	100.00	4.80

Ferry County Sheriff's Office	Ferry	WA	10	1	100.00	13.24
Helen Police Department	White	GA	10	1	100.00	3.68
Ishpeming Police Department	Marquette	MI	10	1	100.00	1.49
Jaffrey Police Department	Cheshire	NH	10	1	100.00	1.30
Kermit Police Department	Winkler	TX	10	1	100.00	14.06
Lancaster Police Department	Garrard	KY	10	1	100.00	5.91
Lander University Public Safety	Greenwood	SC	10	1	100.00	1.44
Marlow Police Department	Stephens	OK	10	1	100.00	2.22
Millersburg Police Department	Holmes	OH	10	1	100.00	2.36
Montague County Sheriff's Office	Montague	TX	10	1	100.00	5.07
New Martinsville Police Department	Wetzel	WV	10	1	100.00	6.03
Powell County Sheriff's Office	Powell	MT	10	1	100.00	14.23
Socorro County Sheriff's Office	Socorro	NM	10	1	100.00	5.60
St. George Police Department	Dorchester	SC	10	1	100.00	2.57
Williams Police Department	Colusa	CA	10	1	100.00	4.67
Winkler County Sheriff's Office	Winkler	TX	10	1	100.00	14.06
Caruthersville Police Department	Pemiscot	MO	21	2	95.24	10.93
Algood Police Department	Putnam	TN	11	1	90.91	1.38
Columbiana County Sheriff's Office	Columbiana	OH	22	2	90.91	1.85
Eastman Police Department	Dodge	GA	11	1	90.91	4.59
Floyd County Sheriff's Office	Floyd	IA	11	1	90.91	6.13
Fort Gibson Police Department	Muskogee	OK	11	1	90.91	1.41
Greene County Sheriff's Office	Greene	AL	11	1	90.91	11.06
Hannahville Tribal Police Department	Menominee	MI	11	1	90.91	4.16
Medina Police Department	Gibson	TN	11	1	90.91	2.01
Missouri Univ. of Science & Tech Police Dept	Phelps	MO	11	1	90.91	2.21
Rainsville Police Department	DeKalb	AL	11	1	90.91	1.41
Roosevelt County Sheriff's Office	Roosevelt	MT	11	1	90.91	9.59
Simpson County Sheriff's Office	Simpson	KY	11	1	90.91	5.77
Stark County Sheriff's Office	Stark	ND	11	1	90.91	4.13
Aspen Police Department	Pitkin	CO	23	2	86.96	11.66
Tuskegee Police Department	Macon	AL	23	2	86.96	9.32
Polk County Police Department	Polk	GA	35	3	85.71	7.23
Braselton Police Department	Jackson	GA	12	1	83.33	1.65
Bunkie Police Department	Avoyelles	LA	12	1	83.33	2.38
Clayton County Sheriff's Office	Clayton	IA	12	1	83.33	5.52

Custer County Sheriff's Office	Custer	OK	12	1	83.33	3.64
Fayette Police Department	Fayette	AL	12	1	83.33	5.80
Franklin County Sheriff's Office	Franklin	IN	12	1	83.33	4.33
Gage County Sheriff's Office	Gage	NE	12	1	83.33	4.48
Lakeport Police Department	Lake	CA	12	1	83.33	1.55
Madill Police Department	Marshall	OK	12	1	83.33	6.31
Monticello Police	White	IN	12	1	83.33	4.06
Natchez Police Dept.	Adams	MS	48	4	83.33	12.39
Perry County Sheriff's Office	Perry	IL	12	1	83.33	4.47
Quincy Police Department	Grant	WA	12	1	83.33	1.12
Wallace Police Department	Duplin	NC	12	1	83.33	1.71
Whitley County Sheriff's Office	Whitley	KY	12	1	83.33	2.81
Williamsburg Police Department	Whitley	KY	12	1	83.33	2.81
Wolfboro Police Department	Carroll	NH	12	1	83.33	2.09
Marlboro County Sheriff's Office	Marlboro	SC	25	2	80.00	6.91
Russellville Police Department	Franklin	AL	25	2	80.00	6.31
Benzie County Sheriff's Office	Benzie	MI	13	1	76.92	5.71
Denton Police Department	Caroline	MD	13	1	76.92	3.02
Emery County Sheriff's Office	Emery	UT	26	2	76.92	18.22
Fairmont Police Department	Robeson	NC	13	1	76.92	0.75
Frisco Police Department	Summit	CO	13	1	76.92	3.57
Hempstead County Sheriff's Office	Hempstead	AR	13	1	76.92	4.42
Humboldt Police Department	Gibson	TN	26	2	76.92	4.03
Pauls Valley Police Department	Garvin	OK	13	1	76.92	3.63
Randolph County Sheriff's Office	Randolph	IL	13	1	76.92	2.99
Tucumcari Police Department	Quay	NM	13	1	76.92	11.06
Upper Sandusky Police Department	Wyandot	OH	13	1	76.92	4.42
Winnfield Police Dept	Winn	LA	13	1	76.92	6.53
Bartlesville Police Department	Washington	OK	54	4	74.07	7.85
Polk County Sheriff's Office	Polk	GA	27	2	74.07	4.82
Appling County Sheriff's Office	Appling	GA	14	1	71.43	5.48
Caribou Police Department	Aroostook	ME	14	1	71.43	1.39
Clyde Police Department	Sandusky	OH	14	1	71.43	1.64
Grants Police Department	Cibola	NM	14	1	71.43	3.67
Morrow County Sheriff's Office	Morrow	OR	14	1	71.43	8.95
Newport Police Department	Sullivan	NH	14	1	71.43	2.29

Ocean Shores Police Department	Grays Harbor	WA	14	1	71.43	1.37
Pelham Police Department	Mitchell	GA	14	1	71.43	4.26
Crossett Police Department	Ashley	AR	15	1	66.67	4.58
Del Norte County Sheriff's Office	Del Norte	CA	30	2	66.67	6.99
Ephrata Police Department	Grant	WA	15	1	66.67	1.12
Greene County Sheriff's Office	Greene	AR	15	1	66.67	2.38
Kings Mountain Police Department	Cleveland	NC	30	2	66.67	2.04
McDowell County Sheriff's Office	McDowell	WV	15	1	66.67	4.52
Mineral Wells Police Department	Palo Pinto	TX	30	2	66.67	7.11
Moab Police Department	Grand	UT	15	1	66.67	10.84
Nashville Police Department	Berrien	GA	15	1	66.67	5.19
Royston Police Department	Franklin	GA	15	1	66.67	4.53
Springfield Police Department	Windsor	VT	15	1	66.67	1.76
St. Marys Police Department	Auglaize	OH	15	1	66.67	2.18
Thief River Falls Police Department	Pennington	MN	15	1	66.67	7.18
Vinita Police Department	Craig	OK	15	1	66.67	6.65
Bishopville Police Department	Lee	SC	16	1	62.50	5.20
Eatonton Police Department	Putnam	GA	16	1	62.50	4.71
Harrodsburg Police Department	Mercer	KY	16	1	62.50	4.69
Lamesa Police Department	Dawson	TX	16	1	62.50	7.23
Miller County Sheriff's Office	Miller	MO	16	1	62.50	4.04
Phillips County Sheriff's Office	Phillips	AR	16	1	62.50	4.60
Red Springs Police Department	Robeson	NC	16	1	62.50	0.75
Cross County Sheriff's Office	Cross	AR	17	1	58.82	5.60
Elkin Police Department	Surry	NC	17	1	58.82	1.36
Fort Madison Police Department	Lee	IA	17	1	58.82	2.79
Kitty Hawk Police Department	Dare	NC	17	1	58.82	2.95
Middlesex County Sheriff's Office	Middlesex	VA	17	1	58.82	9.12
Clovis Police Department	Curry	NM	53	3	56.60	6.20
Zanesville Police Department	Muskingum	OH	53	3	56.60	3.49
Barre Police Department	Washington	VT	18	1	55.56	1.68
Black Mountain Police Department	Buncombe	NC	18	1	55.56	2.22
Bolivar County Sheriff's Office	Bolivar	MS	18	1	55.56	2.93
Calhoun County Sheriff's Office	Calhoun	FL	18	1	55.56	6.84
Duval County Sheriff's Office	Duval	TX	18	1	55.56	8.49
Greensburg Police	Decatur	IN	18	1	55.56	3.89

Hastings Police Dept	Adams	NE	36	2	55.56	6.38
Kendallville Police	Noble	IN	18	1	55.56	2.10
Leland Police Department	Washington	MS	18	1	55.56	1.96
Marion Police Department	Smyth	VA	18	1	55.56	3.10
Osceola County Sheriff's Office	Osceola	MI	18	1	55.56	4.25
Rockmart Police Department	Polk	GA	18	1	55.56	2.41
Seaside Police Department	Clatsop	OR	18	1	55.56	2.70
Selmer Police Department	McNairy	TN	18	1	55.56	3.84
Spencer Police Department	Clay	IA	18	1	55.56	6.00
Sweetwater Police Department	Monroe	TN	18	1	55.56	2.25
Towns County Sheriff's Office	Towns	GA	18	1	55.56	9.55
Winnemucca Police Department	Humboldt	NV	18	1	55.56	6.05
Gaffney Police Department	Cherokee	SC	37	2	54.05	3.61
Brownwood Police Department	Brown	TX	38	2	52.63	5.25
Conneaut Police Department	Ashtabula	OH	19	1	52.63	0.99
Corbin Police Department	Whitley	KY	19	1	52.63	2.81
Daviess County Sheriff's Office	Daviess	IN	19	1	52.63	3.16
Delavan Police Department	Walworth	WI	19	1	52.63	0.98
Demopolis Police Department	Marengo	AL	19	1	52.63	4.76
Norwich Police Department	Chenango	NY	19	1	52.63	1.98
Sturgis Police Department	St. Joseph	MI	19	1	52.63	1.63
Bainbridge Police Department	Decatur	GA	40	2	50.00	7.18
Marksville Police Department	Avoyelles	LA	20	1	50.00	2.38
Oakdale Police Department	Allen	LA	20	1	50.00	3.88
Platteville Police Department	Grant	WI	20	1	50.00	1.95
Vidalia Police Department	Concordia	LA	20	1	50.00	4.80
Wilkesboro Police Department	Wilkes	NC	20	1	50.00	1.44
Bluefield Police Department	Mercer	WV	21	1	47.62	1.61
Bolivar Police Department	Hardeman	TN	21	1	47.62	3.67
Central Michigan University Police Dept	Isabella	MI	21	1	47.62	1.42
Clearlake Police Department	Lake	CA	21	1	47.62	1.55
San Jacinto County Sheriff's Office	San Jacinto	TX	21	1	47.62	3.79
Craig Police Department	Moffat	CO	22	1	45.45	7.25
Hardeman County Sheriff's Office	Hardeman	TN	22	1	45.45	3.67
Haywood County Sheriff's Office	Haywood	TN	22	1	45.45	5.32
Hornell Police Department	Steuben	NY	22	1	45.45	1.01

Indiana Borough Police Department	Indiana	PA	22	1	45.45	1.13
Ketchikan Police Dept.	Ketchikan Gateway	AK	22	1	45.45	7.42
Ontario Police Department	Malheur	OR	22	1	45.45	3.19
Rio Arriba County Sheriff's Office	Rio Arriba	NM	22	1	45.45	2.48
Routt County Sheriff's Office	Routt	CO	22	1	45.45	4.25
Vernal Police Department	Uintah	UT	22	1	45.45	3.07
Washington Court House Police Dept.	Fayette	OH	22	1	45.45	3.44
Butte - Silver Bow County Sheriff's Office	Silver Bow	MT	45	2	44.44	5.85
Muskogee Police Department	Muskogee	OK	90	4	44.44	5.63
St. Landry Parish Sheriff's Office	St. Landry	LA	90	4	44.44	4.80
Beeville Police Department	Bee	TX	23	1	43.48	3.14
Canton Police Dept	Fulton	IL	23	1	43.48	2.70
Danville (City) Sheriff's Office	Danville City	VA	69	3	43.48	6.97
Emmet County Sheriff's Office	Emmet	MI	23	1	43.48	3.06
Graham County Sheriff's Office	Graham	AZ	23	1	43.48	2.69
Monroe County Sheriff's Office	Monroe	WI	23	1	43.48	2.24
Winn Parish Sheriff's Office	Winn	LA	23	1	43.48	6.53
Thomas County Sheriff's Office	Thomas	GA	47	2	42.55	4.47
Cherokee County Sheriff's Office	Cherokee	SC	48	2	41.67	3.61
Commerce Police Department	Jackson	GA	24	1	41.67	1.65
Deridder Police Department	Beauregard	LA	24	1	41.67	2.80
Huron Police Department	Beadle	SD	24	1	41.67	5.75
Jennings Police Department	Jefferson Davis	LA	24	1	41.67	3.17
Marion Police Department	Marion	SC	24	1	41.67	3.02
Orangeburg Public Safety	Orangeburg	SC	72	3	41.67	3.24
Appalachian State University Police Dept	Watauga	NC	25	1	40.00	1.96
Assumption Parish Sheriff's Office	Assumption	LA	50	2	40.00	8.54
Dillon Police Department	Dillon	SC	25	1	40.00	3.12
Lawrence County Sheriff's Office	Lawrence	IN	25	1	40.00	2.17
Newaygo County Sheriff's Office	Newaygo	MI	25	1	40.00	2.06
Ogdensburg Police Department	St. Lawrence	NY	25	1	40.00	0.89
Sault Ste. Marie Police Department	Chippewa	MI	25	1	40.00	2.60
Selma Police Department	Dallas	AL	50	2	40.00	4.56
Tuscola County Sheriff's Office	Tuscola	MI	25	1	40.00	1.79
Hampton County Sheriff's Office	Hampton	SC	26	1	38.46	4.74
Ruidoso Police Department	Lincoln	NM	26	1	38.46	4.88

Steuben County Sheriff's Office	Steuben	NY	26	1	38.46	1.01
Accomack County Sheriff's Office	Accomack	VA	27	1	37.04	3.02
Farmville Police Department	Prince Edward	VA	27	1	37.04	4.28
Jim Wells County Sheriff's Office	Jim Wells	TX	27	1	37.04	2.45
Las Vegas Police Department	San Miguel	NM	27	1	37.04	3.40
Marble Falls Police Department	Burnet	TX	27	1	37.04	2.34
Marion County Sheriff's Office	Marion	WV	27	1	37.04	1.77
Philadelphia Police Department	Neshoba	MS	27	1	37.04	3.37
Rosebud Sioux Tribal Police	Todd	SD	27	1	37.04	10.40
Sandusky Police Department	Erie	OH	54	2	37.04	2.59
Hooksett Police Department	Merrimack	NH	28	1	35.71	0.68
Lee County Sheriff's Office	Lee	SC	28	1	35.71	5.20
Leesville Police Department	Vernon	LA	28	1	35.71	1.91
Vail Police Department	Eagle	CO	28	1	35.71	1.92
White County Sheriff's Office	White	TN	28	1	35.71	3.87
Albert Lea Police Department	Freeborn	MN	29	1	34.48	3.20
Halifax County Sheriff's Office	Halifax	VA	29	1	34.48	2.76
Lenoir County Sheriff's Office	Lenoir	NC	58	2	34.48	3.36
Mount Pleasant Police Department	Titus	TX	29	1	34.48	3.09
Putnam County Sheriff's Office	Putnam	TN	58	2	34.48	2.77
Ravalli County Sheriff's Office	Ravalli	MT	29	1	34.48	2.49
Andalusia Police Dept.	Covington	AL	30	1	33.33	2.65
Berea Police Department	Madison	KY	30	1	33.33	1.21
Great Bend Police Department	Barton	KS	30	1	33.33	3.61
Greenbrier County Sheriff's Office	Greenbrier	WV	30	1	33.33	2.82
Lebanon Police Department	Laclede	MO	30	1	33.33	2.81
Luna County Sheriff's Office	Luna	NM	30	1	33.33	3.98
Miami Police Department	Ottawa	OK	30	1	33.33	3.14
Nogales Police Department	Santa Cruz	AZ	60	2	33.33	4.22
Okanogan County Sheriff's Office	Okanogan	WA	30	1	33.33	2.43
Otero County Sheriff's Office	Otero	NM	30	1	33.33	1.57
Scottsbluff Police Dept	Scotts Bluff	NE	30	1	33.33	2.70
Shelby County Sheriff's Office	Shelby	OH	30	1	33.33	2.02
Warren County Sheriff's Office	Warren	NC	30	1	33.33	4.77
Lake County Sheriff's Office	Lake	CA	61	2	32.79	3.09
Austin Police Department	Mower	MN	31	1	32.26	2.55

Jamestown Police Department	Chautauqua	NY	62	2	32.26	1.48
Murray Police Department	Calloway	KY	31	1	32.26	2.69
Starr County Sheriff's Office	Starr	TX	31	1	32.26	1.64
Stephens County Sheriff's Office	Stephens	GA	31	1	32.26	3.82
Baxter County Sheriff's Office	Baxter	AR	32	1	31.25	2.41
Grand Traverse County Sheriff's Office	Grand Traverse	MI	64	2	31.25	2.30
Manitowoc Police Department	Manitowoc	WI	64	2	31.25	2.46
Moberly Police Department	Randolph	MO	32	1	31.25	3.93
Olean Police Department	Cattaraugus	NY	32	1	31.25	1.25
Tahlequah Police Department	Cherokee	OK	32	1	31.25	2.13
Traverse City Police Department	Grand Traverse	MI	32	1	31.25	1.15
Vernon Parish Sheriff's Office	Vernon	LA	64	2	31.25	3.82
Holmes County Sheriff's Office	Holmes	OH	33	1	30.30	2.36
Meridian Police Department	Lauderdale	MS	99	3	30.30	3.74
Tuskegee University Police Dept	Macon	AL	33	1	30.30	4.66
DeKalb County Sheriff's Office	DeKalb	AL	34	1	29.41	1.41
Fort Payne Police Department	DeKalb	AL	34	1	29.41	1.41
Martin County Sheriff's Office	Martin	NC	34	1	29.41	4.08
Plainview Police Department	Hale	TX	34	1	29.41	2.76
Seneca Police Department	Oconee	SC	34	1	29.41	1.35
Clarksdale Police Department	Coahoma	MS	35	1	28.57	3.82
Cookeville Police Department	Putnam	TN	70	2	28.57	2.77
Lebanon Police Department	Grafton	NH	35	1	28.57	1.12
McKinley County Sheriff's Office	McKinley	NM	35	1	28.57	1.40
New Castle (city) Police Department	Lawrence	PA	35	1	28.57	1.10
New Castle Police	Henry	IN	35	1	28.57	2.02
Bennettsville Police Department	Marlboro	SC	36	1	27.78	3.46
Durant Police Department	Bryan	OK	36	1	27.78	2.36
Kalispell Police Department	Flathead	MT	36	1	27.78	1.10
La Salle County Sheriff's Office	La Salle	IL	36	1	27.78	0.88
Nye County Sheriff's Office	Nye	NV	108	3	27.78	6.83
Union City Police Department	Obion	TN	36	1	27.78	3.14
Washington Police Department	Beaufort	NC	36	1	27.78	2.09
Alice Police Department	Jim Wells	TX	37	1	27.03	2.45
Bogalusa Police Department	Washington	LA	37	1	27.03	2.12
Dunn Police Department	Harnett	NC	37	1	27.03	0.87

Fort Dodge Police Department	Webster	IA	37	1	27.03	2.63
Muskogee County Sheriff's Office	Muskogee	OK	37	1	27.03	1.41
Palatka Police Department	Putnam	FL	37	1	27.03	1.34
Boone Police Department	Watauga	NC	38	1	26.32	1.96
Mount Airy Police Department	Surry	NC	38	1	26.32	1.36
Corinth Police Department	Alcorn	MS	39	1	25.64	2.70
Klamath Falls Police Department	Klamath	OR	39	1	25.64	1.51
Muscatine Police Department	Muscatine	IA	39	1	25.64	2.34
Seymour Police	Jackson	IN	39	1	25.64	2.36
Big Spring Police Department	Howard	TX	40	1	25.00	2.86
McDowell County Sheriff's Office	McDowell	NC	40	1	25.00	2.22
Roswell Police Department	Chaves	NM	80	2	25.00	3.05
White County Sheriff's Office	White	GA	40	1	25.00	3.68
Chesterfield County Sheriff's Office	Chesterfield	SC	41	1	24.39	2.14
Rutland Police Department.	Rutland	VT	41	1	24.39	1.62
Searcy Police Department	White	AR	41	1	24.39	1.30
Kauai (County) Police Department	Kauai	HI	125	3	24.00	4.47
Ada Police Department	Pontotoc	OK	42	1	23.81	2.67
Saline County Sheriff's Office	Saline	IL	42	1	23.81	4.01
Robeson County Sheriff's Office	Robeson	NC	128	3	23.44	2.24
Kingsland Police Dept	Camden	GA	43	1	23.26	1.98
Poplar Bluff Police Department	Butler	MO	43	1	23.26	2.34
Calhoun Police Department	Gordon	GA	44	1	22.73	1.81
Cortland Police Department	Cortland	NY	44	1	22.73	2.03
Juneau Police Dept.	Juneau	AK	44	1	22.73	3.20
Lenawee County Sheriff's Office	Lenawee	MI	44	1	22.73	1.00
Saline County Sheriff's Office	Saline	KS	44	1	22.73	1.80
Scottsboro Police Department	Jackson	AL	44	1	22.73	1.88
Sedalia Police Dept	Pettis	MO	44	1	22.73	2.37
Sullivan County Sheriff's Office	Sullivan	NY	44	1	22.73	1.29
Zapata County Sheriff's Office	Zapata	TX	44	1	22.73	7.13
Gatlinburg Police Department	Sevier	TN	45	1	22.22	1.11
Gillette Police Department	Campbell	WY	45	1	22.22	2.17
Grant County Sheriff's Office	Grant	IN	45	1	22.22	1.43
Harrison County Sheriff's Office	Harrison	TX	45	1	22.22	1.52
Juneau County Sheriff's Office	Juneau	WI	45	1	22.22	3.75

Kingsville Police Department	Kleberg	TX	45	1	22.22	3.12
Natchitoches Parish Sheriff's Office	Natchitoches	LA	45	1	22.22	2.53
Eureka Police Department	Humboldt	CA	46	1	21.74	0.74
Lincoln Parish Sheriff's Office	Lincoln	LA	46	1	21.74	2.14
Mason City Police Department	Cerro Gordo	IA	46	1	21.74	2.26
New Milford Police Department	Litchfield	CT	46	1	21.74	0.53
Chillicothe Police Department	Ross	OH	47	1	21.28	1.28
Lee County Sheriff's Office	Lee	NC	47	1	21.28	1.73
Plattsburgh Police Department	Clinton	NY	47	1	21.28	1.22
Greenville Police Department	Washington	MS	96	2	20.83	3.91
Dodge City Police Department	Ford	KS	49	1	20.41	2.95
Page County Sheriff's Office	Page	VA	49	1	20.41	4.16
Stanly County Sheriff's Office	Stanly	NC	49	1	20.41	1.65
Durango Police Department	La Plata	CO	50	1	20.00	1.95
Kerrville Police Department	Kerr	TX	51	1	19.61	2.02
Shawnee Police Department	Pottawatomie	OK	52	1	19.23	1.44
Galesburg Police Dept	Knox	IL	53	1	18.87	1.89
Paris Police Department	Lamar	TX	54	1	18.52	2.01
Sevierville Police Department	Sevier	TN	55	1	18.18	1.11
Elko County Sheriff's Office	Elko	NV	57	1	17.54	2.05
Wilson Police Department	Wilson	NC	114	2	17.54	2.46
Campbell County Sheriff's Office	Campbell	WY	58	1	17.24	2.17
Opelousas Police Department	St. Landry	LA	58	1	17.24	1.20
Allegan County Sheriff's Office	Allegan	MI	59	1	16.95	0.90
Virginia Marine Resources Commission	Newport News City	VA	60	1	16.67	3.02
Jackson County Sheriff's Office	Jackson	FL	61	1	16.39	2.01
Columbus Police Department	Lowndes	MS	62	1	16.13	1.67
Gallup Police Department	McKinley	NM	62	1	16.13	1.40
Monroe County Sheriff's Office	Monroe	FL	189	3	15.87	4.10
Twin Falls Police Department	Twin Falls	ID	64	1	15.63	1.29
Del Rio Police Department	Val Verde	TX	65	1	15.38	2.05
Frankfort Police Department	Franklin	KY	65	1	15.38	2.03
Lincoln County Sheriff's Office	Lincoln	OR	65	1	15.38	2.17
Richmond Police Department	Madison	KY	65	1	15.38	1.21
Hendry County Sheriff's Office	Hendry	FL	67	1	14.93	2.55
Auburn Police Department	Cayuga	NY	70	1	14.29	1.25

Shelby Police Department	Cleveland	NC	70	1	14.29	1.02
Alamogordo Department of Public Safety	Otero	NM	71	1	14.08	1.57
Lumberton Police Department	Robeson	NC	73	1	13.70	0.75
Stillwater Police Department	Payne	OK	74	1	13.51	1.29
Concord Police Department	Merrimack	NH	77	1	12.99	0.68
Cullman County Sheriff's Office	Cullman	AL	78	1	12.82	1.24
Georgetown County Sheriff's Office	Georgetown	SC	78	1	12.82	1.66
Torrington Police Department	Litchfield	CT	79	1	12.66	0.53
Sanford Police Department	Lee	NC	81	1	12.35	1.73
LaGrange Police Department	Troup	GA	83	1	12.05	1.49
Orangeburg County Sheriff's Office	Orangeburg	SC	92	1	10.87	1.08
Douglas County Sheriff's Office	Douglas	NV	100	1	10.00	2.13
Tupelo Police Department	Lee	MS	115	1	8.70	1.21
Sauk County Sheriff's Office	Sauk	WI	118	1	8.47	1.61
Danville Police Department	Pittsylvania	VA	126	1	7.94	1.57
Navajo Nation Tribal Dept of Law Enforcement	Apache	AZ	393	3	7.63	4.19
New York City Dept of Env. Protection Police	Westchester	NY	168	1	5.95	1.29
Bloomville Police Department	Seneca	OH	0	1		1.76
Dale County Sheriff's Office	Dale	AL	0	1		1.99
Errol Police Department	Coos	NH	0	1		3.03
New Athens Police Department	Harrison	OH	0	1		6.30
Port Jefferson Police Department	Shelby	OH	0	1		2.02
Wheeler Police Department	Dunn	WI	0	1		2.28

Appendix B-3. Primary State Police Agencies in Study: Rates of Officers Arrested, 2005-2011 (Sorted by Rate per 1,000 Officers)

Agency	County	State	# of Full-Time Sworn Personnel	Per Agency	Per 1,000 Officers	Per 100,000 Population
New Mexico State Police	Santa Fe	NM	528	13	24.62	0.63
Arkansas Highway Police	Pulaski	AR	149	2	13.42	0.07
South Carolina Highway Patrol	Richland	SC	967	10	10.34	0.22
Mississippi Highway Safety Patrol	Hinds	MS	594	6	10.10	0.20
Rhode Island State Police	Providence	RI	201	2	9.95	0.19
Florida Highway Patrol	Leon	FL	1606	14	8.72	0.07
New Hampshire State Police	Merrimack	NH	350	3	8.57	0.23
Minnesota State Patrol	Ramsey	MN	530	4	7.55	0.08
Nevada Highway Patrol	Carson	NV	417	3	7.19	0.11
Maryland State Police	Baltimore	MD	1440	9	6.25	0.16
Oklahoma Department of Public Safety	Oklahoma	OK	825	5	6.06	0.13
Pennsylvania State Police	Dauphin	PA	4458	26	5.83	0.20
Colorado State Patrol	Jefferson	CO	742	4	5.39	0.08
Michigan State Police	Ingham	MI	1732	9	5.20	0.09
Wyoming Highway Patrol	Laramie	WY	204	1	4.90	0.18
Illinois State Police	Sangamon	IL	2105	10	4.75	0.08
Delaware State Police	Kent	DE	658	3	4.56	0.33
North Carolina State Highway Patrol	Wake	NC	1827	8	4.38	0.08
Massachusetts State Police	Middlesex	MA	2310	10	4.33	0.15
New Jersey State Police	Mercer	NJ	3053	13	4.26	0.15
Tennessee Department of Safety	Davidson	TN	942	4	4.25	0.06
Utah Department of Public Safety	Salt Lake	UT	475	2	4.21	0.07
Arkansas State Police	Pulaski	AR	525	2	3.81	0.07
Idaho State Police	Ada	ID	264	1	3.79	0.06
Alaska State Troopers	Anchorage	AK	274	1	3.65	0.14
Kentucky State Police	Franklin	KY	882	3	3.40	0.07
Connecticut State Police	Middlesex	CT	1227	4	3.26	0.11
Vermont State Police	Washington	VT	307	1	3.26	0.16
Indiana State Police	Marion	IN	1315	4	3.04	0.06
Iowa Department of Public Safety	Polk	IA	669	2	2.99	0.07
Maine State Police	Kennebec	ME	334	1	2.99	0.08

Alabama Department of Public Safety	Montgomery	AL	763	2	2.62	0.04
Ohio State Highway Patrol	Franklin	OH	1560	4	2.56	0.03
Arizona Department of Public Safety	Maricopa	AZ	1244	3	2.41	0.05
Nebraska State Patrol	Lancaster	NE	491	1	2.04	0.05
California Highway Patrol	Sacramento	CA	7202	13	1.81	0.03
Washington State Patrol	Thurston	WA	1132	2	1.77	0.03
Texas Department of Public Safety	Travis	TX	3529	6	1.70	0.02
Louisiana State Police	East Baton Rouge	LA	1215	2	1.65	0.04
Virginia State Police	Chesterfield	VA	1873	3	1.60	0.04
New York State Police	Albany	NY	4847	5	1.03	0.03
Georgia Department of Public Safety	Fulton	GA	1048	1	0.95	0.01

Appendix B-4. Sheriff's Offices in Study: Rates of Officers Arrested, 2005-2011 (Sorted by Rate per 1,000 Officers)

Agency	County	State	# of Full-Time Sworn Personnel	Per Agency	Per 1,000 Officers	Per 100,000 Population
Nicholas County Sheriff's Office	Nicholas	KY	1	1	1000.00	14.02
Petroleum County Sheriff's Office	Petroleum	MT	1	1	1000.00	202.43
Carter County Sheriff's Office	Carter	MO	3	2	666.67	31.92
Oregon County Sheriff's Office	Oregon	MO	5	2	400.00	18.38
Talbot County Sheriff's Office	Talbot	GA	8	3	375.00	43.70
Baker County Sheriff's Office	Baker	GA	3	1	333.33	28.98
Butler County Sheriff's Office	Butler	AL	9	3	333.33	14.32
Gallatin County Sheriff's Office	Gallatin	IL	3	1	333.33	17.89
Griggs County Sheriff's Office	Griggs	ND	3	1	333.33	41.32
Guadalupe County Sheriff's Office	Guadalupe	NM	3	1	333.33	21.34
La Salle County Sheriff's Office	La Salle	TX	10	3	300.00	43.57
Seneca County Sheriff's Office	Seneca	NY	23	6	260.87	17.02
Bracken County Sheriff's Office	Bracken	KY	4	1	250.00	11.78
Keokuk County Sheriff's Office	Keokuk	IA	4	1	250.00	9.51
Lake County Sheriff's Office	Lake	CO	9	2	222.22	27.36
Jackson County Sheriff's Office	Jackson	TN	14	3	214.29	25.78
Estill County Sheriff's Office	Estill	KY	5	1	200.00	6.82
Grant County Sheriff's Office	Grant	OK	5	1	200.00	22.09
Holt County Sheriff's Office	Holt	NE	5	1	200.00	9.58
Kent County Sheriff's Office	Kent	DE	5	1	200.00	0.62
Lake County Sheriff's Office	Lake	SD	5	1	200.00	8.93
Lewis County Sheriff's Office	Lewis	MO	5	1	200.00	9.79
Mesilla Marshal's Office	Dona Ana	NM	5	1	200.00	0.48
Mora County Sheriff's Office	Mora	NM	5	1	200.00	20.49
Pocahontas County Sheriff's Office	Pocahontas	WV	5	1	200.00	11.47
Terrell County Sheriff's Office	Terrell	TX	5	1	200.00	101.63
Hockley County Sheriff's Office	Hockley	TX	11	2	181.82	8.72
Pulaski County Sheriff's Office	Pulaski	IL	11	2	181.82	32.46
Stephens County Sheriff's Office	Stephens	OK	11	2	181.82	4.44
Union County Sheriff's Office	Union	IN	6	1	166.67	13.30
Woodruff County Sheriff's Office	Woodruff	AR	6	1	166.67	13.77
Clay County Sheriff's Office	Clay	AR	7	1	142.86	6.22

Fremont County Sheriff's Office	Fremont	IA	7	1	142.86	13.44
Mason County Sheriff's Office	Mason	WV	21	3	142.86	10.98
Fayette County Sheriff's Office	Fayette	OH	22	3	136.36	10.33
Big Horn County Sheriff's Office	Big Horn	MT	8	1	125.00	7.77
Blackford County Sheriff's Office	Blackford	IN	8	1	125.00	7.83
Henry County Sheriff's Office	Henry	AL	8	1	125.00	5.78
Henry County Sheriff's Office	Henry	VA	112	14	125.00	25.85
Kingfisher County Sheriff's Office	Kingfisher	OK	8	1	125.00	6.65
Madison County Sheriff's Office	Madison	MO	8	1	125.00	8.18
McIntosh County Sheriff's Office	McIntosh	OK	17	2	117.65	9.88
Ferry County Sheriff's Office	Ferry	WA	10	1	100.00	13.24
Montague County Sheriff's Office	Montague	TX	10	1	100.00	5.07
Powell County Sheriff's Office	Powell	MT	10	1	100.00	14.23
Socorro County Sheriff's Office	Socorro	NM	10	1	100.00	5.60
Winkler County Sheriff's Office	Winkler	TX	10	1	100.00	14.06
Columbiana County Sheriff's Office	Columbiana	OH	22	2	90.91	1.85
Floyd County Sheriff's Office	Floyd	IA	11	1	90.91	6.13
Greene County Sheriff's Office	Greene	AL	11	1	90.91	11.06
Roosevelt County Sheriff's Office	Roosevelt	MT	11	1	90.91	9.59
Simpson County Sheriff's Office	Simpson	KY	11	1	90.91	5.77
Stark County Sheriff's Office	Stark	ND	11	1	90.91	4.13
Dallas County Sheriff's Office	Dallas	IA	23	2	86.96	3.02
Bibb County Sheriff's Office	Bibb	AL	12	1	83.33	4.36
Clayton County Sheriff's Office	Clayton	IA	12	1	83.33	5.52
Custer County Sheriff's Office	Custer	OK	12	1	83.33	3.64
Franklin County Sheriff's Office	Franklin	IN	12	1	83.33	4.33
Gage County Sheriff's Office	Gage	NE	12	1	83.33	4.48
Lincoln County Sheriff's Office	Lincoln	GA	12	1	83.33	12.51
Perry County Sheriff's Office	Perry	IL	12	1	83.33	4.47
Whitley County Sheriff's Office	Whitley	KY	12	1	83.33	2.81
Marlboro County Sheriff's Office	Marlboro	SC	25	2	80.00	6.91
Nez Perce County Sheriff's Office	Nez Perce	ID	25	2	80.00	5.09
Benzie County Sheriff's Office	Benzie	MI	13	1	76.92	5.71
Emery County Sheriff's Office	Emery	UT	26	2	76.92	18.22
Hempstead County Sheriff's Office	Hempstead	AR	13	1	76.92	4.42
Morgan County Sheriff's Office	Morgan	IN	26	2	76.92	2.90

Randolph County Sheriff's Office	Randolph	IL	13	1	76.92	2.99
Hancock County Sheriff's Office	Hancock	IN	40	3	75.00	4.29
Polk County Sheriff's Office	Polk	GA	27	2	74.07	4.82
Lowndes County Sheriff's Office	Lowndes	AL	14	1	71.43	8.85
Morrow County Sheriff's Office	Morrow	OR	14	1	71.43	8.95
Dearborn County Sheriff's Office	Dearborn	IN	29	2	68.97	4.00
Williamson County Sheriff's Office	Williamson	IL	29	2	68.97	3.01
Davie County Sheriff's Office	Davie	NC	45	3	66.67	7.27
Del Norte County Sheriff's Office	Del Norte	CA	30	2	66.67	6.99
Greene County Sheriff's Office	Greene	AR	15	1	66.67	2.38
Jackson County Sheriff's Office	Jackson	KS	15	1	66.67	7.43
Long County Sheriff's Office	Long	GA	15	1	66.67	6.91
McDowell County Sheriff's Office	McDowell	WV	15	1	66.67	4.52
Dewitt County Sheriff's Office	De Witt	IL	16	1	62.50	6.04
Miller County Sheriff's Office	Miller	MO	16	1	62.50	4.04
Phillips County Sheriff's Office	Phillips	AR	16	1	62.50	4.60
Russell County Sheriff's Office	Russell	AL	32	2	62.50	3.78
Caroline County Sheriff's Office	Caroline	VA	49	3	61.22	10.51
Centre County Sheriff's Office	Centre	PA	17	1	58.82	0.65
Cross County Sheriff's Office	Cross	AR	17	1	58.82	5.60
Hunterdon County Sheriff's Office	Hunterdon	NJ	17	1	58.82	0.78
Lincoln County Sheriff's Office	Lincoln	SD	17	1	58.82	2.23
Middlesex County Sheriff's Office	Middlesex	VA	17	1	58.82	9.12
Bolivar County Sheriff's Office	Bolivar	MS	18	1	55.56	2.93
Calhoun County Sheriff's Office	Calhoun	FL	18	1	55.56	6.84
Clarke County Sheriff's Office	Clarke	VA	18	1	55.56	7.13
Dauphin County Sheriff's Office	Dauphin	PA	36	2	55.56	0.75
Duval County Sheriff's Office	Duval	TX	18	1	55.56	8.49
Osceola County Sheriff's Office	Osceola	MI	18	1	55.56	4.25
Towns County Sheriff's Office	Towns	GA	18	1	55.56	9.55
Liberty County Sheriff's Office	Liberty	TX	37	2	54.05	2.64
Daviess County Sheriff's Office	Daviess	IN	19	1	52.63	3.16
Luzerne County Sheriff's Office	Luzerne	PA	38	2	52.63	0.62
Oglethorpe County Sheriff's Office	Oglethorpe	GA	19	1	52.63	6.71
Pawnee County Sheriff's Office	Pawnee	OK	19	1	52.63	6.03
Burleigh County Sheriff's Office	Burleigh	ND	40	2	50.00	2.46

San Jacinto County Sheriff's Office	San Jacinto	TX	21	1	47.62	3.79
Hardeman County Sheriff's Office	Hardeman	TN	22	1	45.45	3.67
Harrison County Sheriff's Office	Harrison	IN	22	1	45.45	2.54
Haywood County Sheriff's Office	Haywood	TN	22	1	45.45	5.32
Rio Arriba County Sheriff's Office	Rio Arriba	NM	22	1	45.45	2.48
Routt County Sheriff's Office	Routt	CO	22	1	45.45	4.25
St. Helena Parish Sheriff's Office	St. Helena	LA	22	1	45.45	8.93
Emmet County Sheriff's Office	Emmet	MI	23	1	43.48	3.06
Graham County Sheriff's Office	Graham	AZ	23	1	43.48	2.69
Monroe County Sheriff's Office	Monroe	WI	23	1	43.48	2.24
Winn Parish Sheriff's Office	Winn	LA	23	1	43.48	6.53
Thomas County Sheriff's Office	Thomas	GA	47	2	42.55	4.47
Cherokee County Sheriff's Office	Cherokee	SC	48	2	41.67	3.61
Lincoln County Sheriff's Office	Lincoln	NC	98	4	40.82	5.11
Assumption Parish Sheriff's Office	Assumption	LA	50	2	40.00	8.54
Bucks County Sheriff's Office	Bucks	PA	50	2	40.00	0.32
Dade County Sheriff's Office	Dade	GA	25	1	40.00	0.04
Lawrence County Sheriff's Office	Lawrence	IN	25	1	40.00	2.17
Newaygo County Sheriff's Office	Newaygo	MI	25	1	40.00	2.06
Tuscola County Sheriff's Office	Tuscola	MI	25	1	40.00	1.79
Hampton County Sheriff's Office	Hampton	SC	26	1	38.46	4.74
Steuben County Sheriff's Office	Steuben	NY	26	1	38.46	1.01
Accomack County Sheriff's Office	Accomack	VA	27	1	37.04	3.02
Crawford County Sheriff's Office	Crawford	AR	27	1	37.04	1.61
Jim Wells County Sheriff's Office	Jim Wells	TX	27	1	37.04	2.45
Marion County Sheriff's Office	Marion	WV	27	1	37.04	1.77
Lee County Sheriff's Office	Lee	SC	28	1	35.71	5.20
White County Sheriff's Office	White	TN	28	1	35.71	3.87
Delaware County Sheriff's Office	Delaware	PA	58	2	34.48	0.36
Halifax County Sheriff's Office	Halifax	VA	29	1	34.48	2.76
Lenoir County Sheriff's Office	Lenoir	NC	58	2	34.48	3.36
Orleans County Sheriff's Office	Orleans	NY	29	1	34.48	2.33
Putnam County Sheriff's Office	Putnam	TN	58	2	34.48	2.77
Ravalli County Sheriff's Office	Ravalli	MT	29	1	34.48	2.49
San Benito County Sheriff's Office	San Benito	CA	29	1	34.48	1.81
Clay County Sheriff's Office	Clay	IN	30	1	33.33	3.72

Greenbrier County Sheriff's Office	Greenbrier	WV	30	1	33.33	2.82
Luna County Sheriff's Office	Luna	NM	30	1	33.33	3.98
Okanogan County Sheriff's Office	Okanogan	WA	30	1	33.33	2.43
Otero County Sheriff's Office	Otero	NM	30	1	33.33	1.57
Shelby County Sheriff's Office	Shelby	OH	30	1	33.33	2.02
Warren County Sheriff's Office	Warren	NC	30	1	33.33	4.77
Lake County Sheriff's Office	Lake	CA	61	2	32.79	3.09
Porter County Sheriff's Office	Porter	IN	61	2	32.79	1.22
Starr County Sheriff's Office	Starr	TX	31	1	32.26	1.64
Stephens County Sheriff's Office	Stephens	GA	31	1	32.26	3.82
Baxter County Sheriff's Office	Baxter	AR	32	1	31.25	2.41
Grand Traverse County Sheriff's Office	Grand Traverse	MI	64	2	31.25	2.30
Vernon Parish Sheriff's Office	Vernon	LA	64	2	31.25	3.82
Livingston County Sheriff's Office	Livingston	MI	65	2	30.77	1.11
Holmes County Sheriff's Office	Holmes	OH	33	1	30.30	2.36
Washtenaw County Sheriff's Office	Washtenaw	MI	133	4	30.08	1.16
DeKalb County Sheriff's Office	DeKalb	AL	34	1	29.41	1.41
Lake County Sheriff's Office	Lake	IN	170	5	29.41	1.01
Madison County Sheriff's Office	Madison	GA	34	1	29.41	3.56
Martin County Sheriff's Office	Martin	NC	34	1	29.41	4.08
Yakima County Sheriff's Office	Yakima	WA	69	2	28.99	0.82
Clark County Sheriff's Office	Clark	IN	35	1	28.57	0.91
McKinley County Sheriff's Office	McKinley	NM	35	1	28.57	1.40
La Salle County Sheriff's Office	La Salle	IL	36	1	27.78	0.88
Nye County Sheriff's Office	Nye	NV	108	3	27.78	6.83
Yamhill County Sheriff's Office	Yamhill	OR	36	1	27.78	1.01
Muskogee County Sheriff's Office	Muskogee	OK	37	1	27.03	1.41
Valencia County Sheriff's Office	Valencia	NM	37	1	27.03	1.31
Woodford County Sheriff's Office	Woodford	IL	37	1	27.03	2.59
Vigo County Sheriff's Office	Vigo	IN	38	1	26.32	0.93
Bedford County Sheriff's Office	Bedford	VA	77	2	25.97	2.91
St. Joseph County Sheriff's Office	St. Joseph	IN	116	3	25.86	1.12
Bullitt County Sheriff's Office	Bullitt	KY	40	1	25.00	1.35
Isle of Wight County Sheriff's Office	Isle of Wight	VA	40	1	25.00	2.84
McDowell County Sheriff's Office	McDowell	NC	40	1	25.00	2.22
Walker County Sheriff's Office	Walker	GA	80	2	25.00	2.91

White County Sheriff's Office	White	GA	40	1	25.00	3.68
Wood County Sheriff's Office	Wood	WV	40	1	25.00	1.15
Iberia Parish Sheriff's Office	Iberia	LA	242	6	24.79	8.19
Chesterfield County Sheriff's Office	Chesterfield	SC	41	1	24.39	2.14
Columbia County Sheriff's Office	Columbia	OR	41	1	24.39	2.03
Walton County Sheriff's Office	Walton	FL	165	4	24.24	7.27
Pitt County Sheriff's Office	Pitt	NC	125	3	24.00	1.78
Hawkins County Sheriff's Office	Hawkins	TN	42	1	23.81	1.76
Saline County Sheriff's Office	Saline	IL	42	1	23.81	4.01
Middlesex County Sheriff's Department	Middlesex	NJ	170	4	23.53	0.49
Wayne County Sheriff's Office	Wayne	NC	85	2	23.53	1.63
Robeson County Sheriff's Office	Robeson	NC	128	3	23.44	2.24
La Crosse County Sheriff's Office	La Crosse	WI	43	1	23.26	0.87
Chambers County Sheriff's Office	Chambers	TX	44	1	22.73	2.85
Lenawee County Sheriff's Office	Lenawee	MI	44	1	22.73	1.00
Saline County Sheriff's Office	Saline	KS	44	1	22.73	1.80
St. Croix County Sheriff's Office	St. Croix	WI	44	1	22.73	1.19
Sullivan County Sheriff's Office	Sullivan	NY	44	1	22.73	1.29
Zapata County Sheriff's Office	Zapata	TX	44	1	22.73	7.13
Grant County Sheriff's Office	Grant	IN	45	1	22.22	1.43
Harrison County Sheriff's Office	Harrison	TX	45	1	22.22	1.52
Juneau County Sheriff's Office	Juneau	WI	45	1	22.22	3.75
Sandoval County Sheriff's Office	Sandoval	NM	45	1	22.22	0.76
St. Martin Parish Sheriff's Office	St. Martin	LA	45	1	22.22	1.92
Upshur County Sheriff's Office	Upshur	TX	45	1	22.22	2.54
Lincoln Parish Sheriff's Office	Lincoln	LA	46	1	21.74	2.14
Rockingham County Sheriff's Office	Rockingham	VA	46	1	21.74	1.31
Polk County Sheriff's Office	Polk	FL	600	13	21.67	2.16
Potter County Sheriff's Office	Potter	TX	93	2	21.51	1.65
Kern County Sheriff's Office	Kern	CA	512	11	21.48	1.31
Cuyahoga County Sheriff's Office	Cuyahoga	OH	141	3	21.28	0.23
Lee County Sheriff's Office	Lee	NC	47	1	21.28	1.73
Rock County Sheriff's Office	Rock	WI	94	2	21.28	1.25
San Juan County Sheriff's Office	San Juan	NM	94	2	21.28	1.54
Polk County Sheriff's Office	Polk	IA	143	3	20.98	0.70
Page County Sheriff's Office	Page	VA	49	1	20.41	4.16

Stanly County Sheriff's Office	Stanly	NC	49	1	20.41	1.65
Baltimore (City) Sheriff's Office	Baltimore City	MD	99	2	20.20	0.32
Williamson County Sheriff's Office	Williamson	TN	99	2	20.20	1.09
Hoke County Sheriff's Office	Hoke	NC	50	1	20.00	2.13
Pottawattamie County Sheriff's Office	Pottawattomie	IA	50	1	20.00	1.07
Queen Anne's County Sheriff's Office	Queen Annes	MD	50	1	20.00	2.09
St. John The Baptist Parish Sheriff's Office	St. John the Baptist	LA	150	3	20.00	6.53
St. Louis County Sheriff's Office	St. Louis	MO	200	4	20.00	0.40
Allegheny County Sheriff's Office	Allegheny	PA	151	3	19.87	0.25
Forsyth County Sheriff's Office	Forsyth	GA	253	5	19.76	2.85
Barnstable County Sheriff's Office	Barnstable	MA	254	5	19.69	2.32
Hidalgo County Sheriff's Office	Hidalgo	TX	262	5	19.08	0.65
Cameron County Sheriff's Office	Cameron	TX	107	2	18.69	0.49
Nassau County Sheriff's Office	Nassau	FL	109	2	18.35	2.73
Horry County Sheriff's Office	Horry	SC	55	1	18.18	0.37
Morgan County Sheriff's Office	Morgan	AL	55	1	18.18	0.84
Yellowstone County Sheriff's Office	Yellowstone	MT	55	1	18.18	0.68
Brunswick County Sheriff's Office	Brunswick	NC	114	2	17.54	1.86
Elko County Sheriff's Office	Elko	NV	57	1	17.54	2.05
Pender County Sheriff's Office	Pender	NC	57	1	17.54	1.92
Ulster County Sheriff's Office	Ulster	NY	57	1	17.54	0.55
Campbell County Sheriff's Office	Campbell	WY	58	1	17.24	2.17
La Porte County Sheriff's Office	La Porte	IN	58	1	17.24	0.90
Allegan County Sheriff's Office	Allegan	MI	59	1	16.95	0.90
New York City Sheriff's Office	New York	NY	120	2	16.67	2.44
Jackson County Sheriff's Office	Jackson	FL	61	1	16.39	2.01
Kershaw County Sheriff's Office	Kershaw	SC	61	1	16.39	1.62
Monroe County Sheriff's Office	Monroe	FL	189	3	15.87	4.10
Darlington County Sheriff's Office	Darlington	SC	64	1	15.63	1.46
Hamilton County Sheriff's Office	Hamilton	IN	64	1	15.63	0.36
Shelby County Sheriff's Office	Shelby	TN	516	8	15.50	0.86
Charleston County Sheriff's Office	Charleston	SC	259	4	15.44	1.14
Flagler County Sheriff's Office	Flagler	FL	130	2	15.38	2.09
Laurens County Sheriff's Office	Laurens	SC	65	1	15.38	1.50
Lincoln County Sheriff's Office	Lincoln	OR	65	1	15.38	2.17
Pennington County Sheriff's Office	Pennington	SD	65	1	15.38	0.99

Portage County Sheriff's Office	Portage	OH	66	1	15.15	0.62
Hendry County Sheriff's Office	Hendry	FL	67	1	14.93	2.55
Marathon County Sheriff's Office	Marathon	WI	67	1	14.93	0.75
McHenry County Sheriff's Office	McHenry	IL	134	2	14.93	0.65
Jefferson Parish Sheriff's Office	Jefferson	LA	825	12	14.55	2.77
Minnehaha County Sheriff's Office	Minnehaha	SD	69	1	14.49	0.59
Cleveland County Sheriff's Office	Cleveland	OK	70	1	14.29	0.39
Saginaw County Sheriff's Office	Saginaw	MI	71	1	14.08	0.50
Lucas County Sheriff's Office	Lucas	OH	289	4	13.84	0.91
Hamilton County Sheriff's Office	Hamilton	TN	146	2	13.70	0.59
Hudson County Sheriff's Office	Hudson	NJ	221	3	13.57	0.47
Outagamie County Sheriff's Office	Outagamie	WI	74	1	13.51	0.57
Milwaukee County Sheriff's Office	Milwaukee	WI	524	7	13.36	0.74
Prince William County Sheriff's Office	Prince William	VA	75	1	13.33	0.25
Santa Fe County Sheriff's Office	Santa Fe	NM	75	1	13.33	0.69
Indian River County Sheriff's Office	Indian River	FL	226	3	13.27	2.17
St. Charles County Sheriff's Office	St. Charles	MO	153	2	13.07	0.55
Dakota County Sheriff's Office	Dakota	MN	77	1	12.99	0.25
Eaton County Sheriff's Office	Eaton	MI	77	1	12.99	0.93
Prince George's County Sheriff's Office	Prince Georges	MD	233	3	12.88	0.35
Cullman County Sheriff's Office	Cullman	AL	78	1	12.82	1.24
Franklin County Sheriff's Office	Franklin	VA	78	1	12.82	1.78
Madera County Sheriff's Office	Madera	CA	78	1	12.82	0.66
San Luis Obispo County Sheriff's Office	San Luis Obispo	CA	156	2	12.82	0.74
Ozaukee County Sheriff's Office	Ozaukee	WI	83	1	12.05	1.16
Baltimore County Sheriff's Office	Baltimore	MD	84	1	11.90	0.12
Burke County Sheriff's Office	Burke	NC	86	1	11.63	1.10
Delaware County Sheriff's Office	Delaware	OH	86	1	11.63	0.57
Okaloosa County Sheriff's Office	Okaloosa	FL	258	3	11.63	1.66
Washington County Sheriff's Office	Washington	TN	86	1	11.63	0.81
Carver County Sheriff's Office	Carver	MN	87	1	11.49	1.10
Orange County Sheriff's Office	Orange	FL	1398	16	11.44	1.40
Smith County Sheriff's Office	Smith	TX	88	1	11.36	0.48
Passaic County Sheriff's Office	Passaic	NJ	530	6	11.32	1.20
Wake County Sheriff's Office	Wake	NC	354	4	11.30	0.44
Lee County Sheriff's Office	Lee	FL	621	7	11.27	1.13

Richmond County Sheriff's Office	Richmond	GA	449	5	11.14	2.49
Harrison County Sheriff's Office	Harrison	MS	90	1	11.11	0.53
Monroe County Sheriff's Office	Monroe	NY	273	3	10.99	0.40
Kane County Sheriff's Office	Kane	IL	92	1	10.87	0.19
Orangeburg County Sheriff's Office	Orangeburg	SC	92	1	10.87	1.08
Bernalillo County Sheriff's Office	Bernalillo	NM	279	3	10.75	0.45
Lancaster County Sheriff's Office	Lancaster	SC	93	1	10.75	1.30
Washington County Sheriff's Office	Washington	MD	94	1	10.64	0.68
Rutherford County Sheriff's Office	Rutherford	TN	189	2	10.58	0.76
Clay County Sheriff's Office	Clay	FL	284	3	10.56	1.57
Charlotte County Sheriff's Office	Charlotte	FL	285	3	10.53	1.88
Lake County Sheriff's Office	Lake	FL	286	3	10.49	1.01
Anderson County Sheriff's Office	Anderson	SC	191	2	10.47	1.07
Lafourche Parish Sheriff's Office	Lafourche	LA	287	3	10.45	3.11
Bibb County Sheriff's Office	Bibb	GA	290	3	10.34	1.93
Johnston County Sheriff's Office	Johnston	NC	97	1	10.31	0.59
Orange County Sheriff's Office	Orange	NY	99	1	10.10	0.27
Bossier Parish Sheriff's Office	Bossier	LA	300	3	10.00	2.56
Douglas County Sheriff's Office	Douglas	NV	100	1	10.00	2.13
Broward County Sheriff's Office	Broward	FL	1624	16	9.85	0.92
Atlantic County Sheriff's Office	Atlantic	NJ	103	1	9.71	0.36
Benton County Sheriff's Office	Benton	AR	103	1	9.71	0.45
Columbia County Sheriff's Office	Columbia	GA	206	2	9.71	1.61
Williamson County Sheriff's Office	Williamson	TX	206	2	9.71	0.47
Washoe County Sheriff's Office	Washoe	NV	414	4	9.66	0.95
Collier County Sheriff's Office	Collier	FL	628	6	9.55	1.87
Acadia Parish Sheriff's Office	Acadia	LA	105	1	9.52	1.62
New Hanover County Sheriff's Office	New Hanover	NC	315	3	9.52	1.48
Sutter County Sheriff's Office	Sutter	CA	105	1	9.52	1.06
Bexar County Sheriff's Office	Bexar	TX	526	5	9.51	0.29
Marion County Sheriff's Office	Marion	IN	740	7	9.46	0.77
Bay County Sheriff's Office	Bay	FL	213	2	9.39	1.18
Madison County Sheriff's Office	Madison	AL	107	1	9.35	0.30
Pinellas County Sheriff's Office	Pinellas	FL	863	8	9.27	0.87
Forsyth County Sheriff's Office	Forsyth	NC	217	2	9.22	0.57
Pinal County Sheriff's Office	Pinal	AZ	218	2	9.17	0.53

Butte County Sheriff's Office	Butte	CA	110	1	9.09	0.45
Niagara County Sheriff's Office	Niagara	NY	110	1	9.09	0.46
Volusia County Sheriff's Office	Volusia	FL	450	4	8.89	0.81
Solano County Sheriff's Office	Solano	CA	113	1	8.85	0.24
Clay County Sheriff's Office	Clay	MO	115	1	8.70	0.45
Orange County Sheriff's Office	Orange	NC	115	1	8.70	0.75
Whitfield County Sheriff's Office	Whitfield	GA	115	1	8.70	0.97
Marion County Sheriff's Office	Marion	FL	349	3	8.60	0.91
Ramsey County Sheriff's Office	Ramsey	MN	235	2	8.51	0.39
Sauk County Sheriff's Office	Sauk	WI	118	1	8.47	1.61
Manatee County Sheriff's Office	Manatee	FL	476	4	8.40	1.24
East Baton Rouge Parish Sheriff's Office	East Baton Rouge	LA	359	3	8.36	0.68
St. Mary's County Sheriff's Office	St. Marys	MD	120	1	8.33	0.95
Palm Beach County Sheriff's Office	Palm Beach	FL	1447	12	8.29	0.91
Kitsap County Sheriff's Office	Kitsap	WA	121	1	8.26	0.40
Weld County Sheriff's Office	Weld	CO	121	1	8.26	0.40
Pasco County Sheriff's Office	Pasco	FL	485	4	8.25	0.86
Kenosha County Sheriff's Office	Kenosha	WI	122	1	8.20	0.60
Spokane County Sheriff's Office	Spokane	WA	244	2	8.20	0.42
Hillsborough County Sheriff's Office	Hillsborough	FL	1223	10	8.18	0.81
El Paso County Sheriff's Office	El Paso	TX	248	2	8.06	0.25
Livingston Parish Sheriff's Office	Livingston	LA	125	1	8.00	0.78
Catawba County Sheriff's Office	Catawba	NC	126	1	7.94	0.65
Orleans Parish Sheriff's Office (Criminal Division)	Orleans	LA	505	4	7.92	1.16
Barrow County Sheriff's Office	Barrow	GA	127	1	7.87	1.44
Brazoria County Sheriff's Office	Brazoria	TX	127	1	7.87	0.32
Orange County Sheriff-Coroner Department	Orange	CA	1794	14	7.80	0.47
Hall County Sheriff's Office	Hall	GA	257	2	7.78	1.11
Fulton County Sheriff's Office	Fulton	GA	516	4	7.75	0.43
Escambia County Sheriff's Office	Escambia	FL	388	3	7.73	1.01
St. Lucie County Sheriff's Office	St. Lucie	FL	259	2	7.72	0.72
Boone County Sheriff's Office	Boone	KY	130	1	7.69	0.84
Highlands County Sheriff's Office	Highlands	FL	130	1	7.69	1.01
Anoka County Sheriff's Office	Anoka	MN	133	1	7.52	0.30
Clark County Sheriff's Office	Clark	OH	134	1	7.46	0.72
Coweta County Sheriff's Office	Coweta	GA	137	1	7.30	0.79

Winnebago County Sheriff's Office	Winnebago	IL	142	1	7.04	0.34
Snohomish County Sheriff's Office	Snohomish	WA	287	2	6.97	0.28
King County Sheriff's Office	King	WA	721	5	6.93	0.26
Lowndes County Sheriff's Office	Lowndes	GA	145	1	6.90	0.92
Plaquemines Parish Sheriff's Office	Plaquemines	LA	145	1	6.90	4.34
Pierce County Sheriff's Office	Pierce	WA	292	2	6.85	0.25
Denver County Sheriff's Office	Denver	CO	739	5	6.77	0.83
Leon County Sheriff's Office	Leon	FL	443	3	6.77	1.09
Spartanburg County Sheriff's Office	Spartanburg	SC	297	2	6.73	0.70
Terrebonne Parish Sheriff's Office	Terrebonne	LA	300	2	6.67	1.79
Waukesha County Sheriff's Office	Waukesha	WI	150	1	6.67	0.26
Newton County Sheriff's Office	Newton	GA	152	1	6.58	1.00
Salem County Sheriff's Office	Salem	NJ	157	1	6.37	1.51
Clackamas County Sheriff's Office	Clackamas	OR	319	2	6.27	0.53
DeKalb County Sheriff's Office	DeKalb	GA	325	2	6.15	0.29
San Bernardino County Sheriff's Office	San Bernardino	CA	1797	11	6.12	0.54
Fairfax County Sheriff's Office	Fairfax	VA	499	3	6.01	0.28
Union County Sheriff's Office	Union	NC	170	1	5.88	0.50
Richland County Sheriff's Office	Richland	SC	512	3	5.86	0.78
Tulare County Sheriff's Office	Tulare	CA	513	3	5.85	0.68
Boulder County Sheriff's Office	Boulder	CO	174	1	5.75	0.34
Paulding County Sheriff's Office	Paulding	GA	175	1	5.71	0.70
Frederick County Sheriff's Office	Frederick	MD	177	1	5.65	0.43
Gwinnett County Sheriff's Office	Gwinnett	GA	531	3	5.65	0.37
Seminole County Sheriff's Office	Seminole	FL	355	2	5.63	0.47
Chesapeake (City) Sheriff's Office	Chesapeake City	VA	358	2	5.59	0.90
Adams County Sheriff's Office	Adams	CO	364	2	5.49	0.45
Sullivan County Sheriff's Office	Sullivan	TN	183	1	5.46	0.64
Lake County Sheriff's Office	Lake	IL	188	1	5.32	0.14
San Diego County Sheriff's Office	San Diego	CA	1322	7	5.30	0.23
St. Bernard Parish Sheriff's Office	St. Bernard	LA	189	1	5.29	2.79
Santa Rosa County Sheriff's Office	Santa Rosa	FL	190	1	5.26	0.66
Osceola County Sheriff's Office	Osceola	FL	388	2	5.15	0.74
Riverside County Sheriff's Office	Riverside	CA	2147	11	5.12	0.50
Greenville County Sheriff's Office	Greenville	SC	397	2	5.04	0.44
Marin County Sheriff's Office	Marin	CA	202	1	4.95	0.40

Wilson County Sheriff's Office	Wilson	TN	202	1	4.95	0.88
Arapahoe County Sheriff's Office	Arapahoe	CO	407	2	4.91	0.35
St. Tammany Parish Sheriff's Office	St. Tammany	LA	409	2	4.89	0.86
Beaufort County Sheriff's Office	Beaufort	SC	209	1	4.78	0.62
Rapides Parish Sheriff's Office	Rapides	LA	212	1	4.72	0.76
Richmond (City) Sheriff's Office	Richmond City	VA	424	2	4.72	0.98
Montgomery County Sheriff's Office	Montgomery	OH	222	1	4.50	0.19
Loudoun County Sheriff's Office	Loudoun	VA	448	2	4.46	0.64
Chesterfield County Sheriff's Office	Chesterfield	VA	225	1	4.44	0.32
Dane County Sheriff's Office	Dane	WI	454	2	4.41	0.41
Franklin County Sheriff's Office	Franklin	OH	455	2	4.40	0.17
Placer County Sheriff's Office	Placer	CA	228	1	4.39	0.29
Stanislaus County Sheriff's Office	Stanislaus	CA	230	1	4.35	0.19
Sacramento County Sheriff's Office	Sacramento	CA	1409	6	4.26	0.42
Galveston County Sheriff's Office	Galveston	TX	240	1	4.17	0.34
Onondaga County Sheriff's Office	Onondaga	NY	242	1	4.13	0.21
Macomb County Sheriff's Office	Macomb	MI	245	1	4.08	0.12
Brevard County Sheriff's Office	Brevard	FL	497	2	4.02	0.37
Hernando County Sheriff's Office	Hernando	FL	249	1	4.02	0.58
Marion County Sheriff's Office	Marion	OR	255	1	3.92	0.32
Morris County Sheriff's Office	Morris	NJ	262	1	3.82	0.20
Alachua County Sheriff's Office	Alachua	FL	276	1	3.62	0.40
Harford County Sheriff's Office	Harford	MD	280	1	3.57	0.41
Montgomery County Sheriff's Office	Montgomery	TN	287	1	3.48	0.58
St. Charles Parish Sheriff's Office	St. Charles	LA	291	1	3.44	1.89
Santa Barbara County Sheriff's Office	Santa Barbara	CA	294	1	3.40	0.24
Hamilton County Sheriff's Office	Hamilton	OH	330	1	3.03	0.12
Maricopa County Sheriff's Office	Maricopa	AZ	766	2	2.61	0.05
Summit County Sheriff's Office	Summit	OH	393	1	2.54	0.18
Sarasota County Sheriff's Office	Sarasota	FL	409	1	2.44	0.26
Martin County Sheriff's Office	Martin	FL	414	1	2.42	0.68
Norfolk (City) Sheriff's Office	Norfolk City	VA	414	1	2.42	0.41
Ouachita Parish Sheriff's Office	Ouachita	LA	431	1	2.32	0.65
Cobb County Sheriff's Office	Cobb	GA	435	1	2.30	0.15
Will County Sheriff's Office	Will	IL	445	1	2.25	0.15
Dallas County Sheriff's Office	Dallas	TX	449	1	2.23	0.04

Santa Clara County Sheriff's Office	Santa Clara	CA	450	1	2.22	0.06
El Paso County Sheriff's Office	El Paso	CO	454	1	2.20	0.16
Knox County Sheriff's Office	Knox	TN	456	1	2.19	0.23
Fresno County Sheriff's Office	Fresno	CA	461	1	2.17	0.11
Alameda County Sheriff's Office	Alameda	CA	928	2	2.16	0.13
Monmouth County Sheriff's Office	Monmouth	NJ	494	1	2.02	0.16
Pima County Sheriff's Dept.	Pima	AZ	554	1	1.81	0.10
Calcasieu Parish Sheriff's Office	Calcasieu	LA	592	1	1.69	0.52
Los Angeles County Sheriff's Office	Los Angeles	CA	9461	14	1.48	0.14
Contra Costa County Sheriff's Office	Contra Costa	CA	679	1	1.47	0.10
Cook County Sheriff's Office	Cook	IL	5655	8	1.41	0.15
Ventura County Sheriff's Office	Ventura	CA	755	1	1.32	0.12
Harris County Sheriff's Office	Harris	TX	2558	3	1.17	0.07
Wayne County Sheriff's Office	Wayne	MI	1062	1	0.94	0.05
Dale County Sheriff's Office	Dale	AL	0	1		1.99
Westmoreland County Sheriff's Office	Westmoreland	PA	0	1		0.27
Wicomico County Sheriff's Office	Wicomico	MD	0	1		1.01

Appendix B-5. County Police Departments in Study: Rates of Officers Arrested, 2005-2011 (Sorted by Rate per 1,000 Officers)

Agency	County	State	# of Full-Time Sworn Personnel	Per Agency	Per 1,000 Officers	Per 100,000 Population
Polk County Police Department	Polk	GA	35	3	85.71	7.23
Oldham County Police Department	Oldham	KY	31	2	64.52	3.32
Dougherty County Police Dept.	Dougherty	GA	47	2	42.55	2.11
Horry County Police Department	Horry	SC	243	9	37.04	3.34
Kauai (County) Police Department	Kauai	HI	125	3	24.00	4.47
Indianapolis Police	Marion	IN	1582	33	20.86	3.65
Fulton County Police Department	Fulton	GA	129	2	15.50	0.22
Maui (County) Police Department	Maui	HI	329	5	15.20	3.23
Gaston County Police Department	Gaston	NC	133	2	15.04	0.97
Roanoke County Police Department	Roanoke	VA	135	2	14.81	2.17
Floyd County Police Department	Floyd	GA	71	1	14.08	1.04
Honolulu (City and County) Police Department	Honolulu	HI	1934	26	13.44	2.73
Montgomery County Police Department	Montgomery	MD	1206	16	13.27	1.65
DeKalb County Police Department	DeKalb	GA	1074	13	12.10	1.88
Prince George's County Police Department	Prince Georges	MD	1578	19	12.04	2.20
Charlotte - Mecklenburg Police Department	Mecklenburg	NC	1672	20	11.96	2.17
Savannah-Chatham Metropolitan Police Department	Chatham	GA	534	6	11.24	2.26
Westchester County Department of Public Safety	Westchester	NY	270	3	11.11	0.32
James City County Police Dept.	James City	VA	94	1	10.64	1.49
Allegheny County Police Department.	Allegheny	PA	202	2	9.90	0.16
Riley County Police Department	Riley	KS	101	1	9.90	1.41
Athens-Clarke County Police Dept	Clarke	GA	213	2	9.39	1.71
Clayton County Police Department	Clayton	GA	336	3	8.93	1.16
Cobb County Police Department	Cobb	GA	590	5	8.47	0.73
Miami-Dade (County) Police Department	Miami-Dade	FL	3093	25	8.08	1.00
Henrico County Division of Police	Henrico	VA	554	4	7.22	1.30
Howard County Police Department	Howard	MD	424	3	7.08	1.04
Gwinnett County Police Department	Gwinnett	GA	682	4	5.87	0.50
New Castle County Police Department	New Castle	DE	358	2	5.59	0.37
Prince William County Police Department	Prince William	VA	546	3	5.49	0.75
Fairfax County Police Department	Fairfax	VA	1419	7	4.93	0.65
Anne Arundel County Police Department	Anne Arundel	MD	633	3	4.74	0.56

Henry County Police Department	Henry	GA	225	1	4.44	0.49
Arlington County Police Department	Arlington	VA	364	1	2.75	0.48
St. Louis County Police Dept	St. Louis	MO	781	2	2.56	0.20
Suffolk County Police Department	Suffolk	NY	2622	6	2.29	0.40
Nassau County Police Department	Nassau	NY	2732	6	2.20	0.45
Chesterfield County Police Department	Chesterfield	VA	475	1	2.11	0.32
Baltimore County Police Department	Baltimore	MD	1910	4	2.09	0.50

Appendix B-6. 500 Largest Municipal Police Departments in Study: Rates of Officers Arrested, 2005-2011 (Sorted by Rate per 1,000 Officers)

Agency	County	State	# of Full-Time Sworn Personnel	Per Agency	Per 1,000 Officers	Per 100,000 Population
Hackensack Police	Bergen	NJ	117	9	76.92	0.99
Norwich Police Department	New London	CT	81	5	61.73	1.82
Riviera Beach Police Department	Palm Beach	FL	108	6	55.56	0.45
Lorain Police Department	Lorain	OH	100	5	50.00	1.66
Charleston Police Department	Kanawha	WV	182	9	49.45	4.66
Schenectady Police Department	Schenectady	NY	166	8	48.19	5.17
Edinburg Police Department	Hidalgo	TX	110	5	45.45	0.65
Cleveland Police Department	Bradley	TN	89	4	44.94	4.04
Muskogee Police Department	Muskogee	OK	90	4	44.44	5.63
New Orleans Police Department	Orleans	LA	1425	63	44.21	18.32
Greece Town Police Department	Monroe	NY	94	4	42.55	0.54
Portsmouth Police Department	Portsmouth City	VA	235	10	42.55	10.47
Boynton Beach Police Department	Palm Beach	FL	165	7	42.42	0.53
Enfield Police Department	Hartford	CT	95	4	42.11	0.45
Gary Police	Lake	IN	243	10	41.15	2.02
Woonsocket Police Department	Providence	RI	99	4	40.40	0.64
Farmington Police Department	San Juan	NM	129	5	38.76	3.84
Edison Police	Middlesex	NJ	189	7	37.04	0.86
Milwaukee Police Department	Milwaukee	WI	1987	73	36.74	7.70
Anderson Police	Madison	IN	117	4	34.19	3.04
Coconut Creek Police Department	Broward	FL	89	3	33.71	0.17
Macon Police Department	Bibb	GA	270	9	33.33	5.79
Waterloo Police Department	Black Hawk	IA	120	4	33.33	3.05
Plainfield Police Department	Union	NJ	151	5	33.11	0.93
Anderson Police Department	Anderson	SC	91	3	32.97	1.60
Parma Police Department	Cuyahoga	OH	92	3	32.61	0.23
Waco Police Department	McLennan	TX	246	8	32.52	3.41
Chattanooga Police Department	Hamilton	TN	434	14	32.26	4.16
Elkhart Police	Elkhart	IN	124	4	32.26	2.02
Fort Pierce Police Department	St. Lucie	FL	126	4	31.75	1.44
South Bend Police	St. Joseph	IN	255	8	31.37	3.00
Meridian Police Department	Lauderdale	MS	99	3	30.30	3.74

Provo Police Department	Utah	UT	99	3	30.30	0.58
Dubuque Police Department	Dubuque	IA	100	3	30.00	3.20
Norwalk Police Department	Fairfield	CT	167	5	29.94	0.55
Memphis Police Department	Shelby	TN	1549	46	29.70	4.96
Flint Police Department	Genesee	MI	204	6	29.41	1.41
Muncie Police	Delaware	IN	102	3	29.41	2.55
Carmel Police	Hamilton	IN	104	3	28.85	1.09
Berwyn Police Dept	Cook	IL	105	3	28.57	0.06
Burlington Police Department	Alamance	NC	105	3	28.57	1.99
Homestead Police Department	Miami-Dade	FL	106	3	28.30	0.12
Kansas City Police Department	Wyandotte	KS	354	10	28.25	6.35
Sumter Police Department	Sumter	SC	107	3	28.04	2.79
Myrtle Beach Police Department	Horry	SC	179	5	27.93	1.86
Elgin Police Dept	Kane	IL	181	5	27.62	0.97
Cicero Police Dept	Cook	IL	146	4	27.40	0.08
Kingsport Police Department	Sullivan	TN	111	3	27.03	1.91
Stratford Police Department	Fairfield	CT	111	3	27.03	0.33
Lawrence Police Department	Essex	MA	151	4	26.49	0.54
Bethlehem Police Department	Northampton	PA	154	4	25.97	1.34
Scranton Police Department	Lackawanna	PA	155	4	25.81	1.87
Hollywood Police Department	Broward	FL	316	8	25.32	0.46
Camden Police	Camden	NJ	397	10	25.19	1.95
Ann Arbor Police Department	Washtenaw	MI	160	4	25.00	1.16
Sandy Springs Police Department	Fulton	GA	120	3	25.00	0.33
Tinley Park Police Dept	Cook	IL	81	2	24.69	0.04
Bolingbrook Police Dept	Will	IL	122	3	24.59	0.44
Hartford Police Department	Hartford	CT	408	10	24.51	1.12
Petersburg Police Department	Petersburg City	VA	82	2	24.39	6.17
Newport News Police Department	Newport News City	VA	415	10	24.10	5.53
Port Orange Police Department	Volusia	FL	83	2	24.10	0.40
Salem Police Department	Essex	MA	83	2	24.10	0.27
Daytona Beach Police Department	Volusia	FL	250	6	24.00	1.21
Wheeling Police Department	Ohio	WV	84	2	23.81	4.50
Pittsburgh Police Department	Allegheny	PA	891	21	23.57	1.72
Fort Myers Police Department	Lee	FL	170	4	23.53	0.65
Texas City Police Department	Galveston	TX	85	2	23.53	0.69

Shreveport Police Department	Caddo	LA	511	12	23.48	4.71
Murfreesboro Police Department	Rutherford	TN	213	5	23.47	1.90
Bend Police Department	Deschutes	OR	86	2	23.26	1.27
Brookline Police Department	Norfolk	MA	129	3	23.26	0.45
Cuyahoga Falls Police Department	Summit	OH	86	2	23.26	0.37
Elyria Police Department	Lorain	OH	86	2	23.26	0.66
Bakersfield Police Department	Kern	CA	348	8	22.99	0.95
Columbia Police Department	Richland	SC	351	8	22.79	2.08
Chico Police Department	Butte	CA	88	2	22.73	0.91
Folsom Police Department	Sacramento	CA	88	2	22.73	0.14
Salinas Police Department	Monterey	CA	177	4	22.60	0.96
Greenville Police Department	Greenville	SC	178	4	22.47	0.89
Westminster Police Dept	Adams	CO	178	4	22.47	0.91
Dover Police Department	Kent	DE	90	2	22.22	1.23
New London Police Department	New London	CT	90	2	22.22	0.73
Lakeland Police Department	Polk	FL	226	5	22.12	0.83
Kissimmee Police Department	Osceola	FL	136	3	22.06	1.12
Albany Police Department	Dougherty	GA	184	4	21.74	4.23
New Braunfels Police Department	Comal	TX	92	2	21.74	1.84
Albany Police Department	Albany	NY	328	7	21.34	2.30
Alameda Police Department	Alameda	CA	94	2	21.28	0.13
Egg Harbor Township Police	Atlantic	NJ	95	2	21.05	0.73
San Leandro Police Department	Alameda	CA	95	2	21.05	0.13
Clarksville Police Department	Montgomery	TN	238	5	21.01	7.54
Greenville Police Department	Washington	MS	96	2	20.83	3.91
Pharr Police Department	Hidalgo	TX	96	2	20.83	0.26
Niagara Falls Police Department	Niagara	NY	145	3	20.69	1.39
Pueblo Police Dept	Pueblo	CO	195	4	20.51	2.51
Spokane Police Department	Spokane	WA	295	6	20.34	1.27
Cranston Police Department	Providence	RI	148	3	20.27	1.81
Conroe Police Department	Montgomery	TX	99	2	20.20	0.44
Dearborn Police Department	Wayne	MI	198	4	20.20	0.22
Middletown Police Department	Middlesex	CT	99	2	20.20	1.21
Pinellas Park Police Department	Pinellas	FL	99	2	20.20	0.22
Westminster Police Department	Orange	CA	100	2	20.00	0.07
Minneapolis Police Department	Hennepin	MN	902	18	19.96	1.56

Jackson Police Department	Madison	TN	204	4	19.61	4.07
West Jordan Police Department	Salt Lake	UT	102	2	19.61	0.19
Medford Police Department	Jackson	OR	103	2	19.42	0.98
Springfield Police Department	Hampden	MA	464	9	19.40	1.94
Hoboken Police	Hudson	NJ	156	3	19.23	0.47
Pasadena Police Department	Harris	TX	260	5	19.23	0.12
Modesto Police Department	Stanislaus	CA	262	5	19.08	0.97
Hamden Police Department	New Haven	CT	105	2	19.05	0.23
Oceanside Police Department	San Diego	CA	210	4	19.05	0.13
Fort Smith Police Department	Sebastian	AR	158	3	18.99	2.39
Allen Police Department	Collin	TX	106	2	18.87	0.26
Fullerton Police Department	Orange	CA	159	3	18.87	0.10
Portland Police Department	Cumberland	ME	159	3	18.87	1.07
Victoria Police Department	Victoria	TX	106	2	18.87	2.30
Jackson Police Department	Hinds	MS	480	9	18.75	3.67
Toledo Police Department	Lucas	OH	640	12	18.75	2.72
Rapid City Police Department	Pennington	SD	107	2	18.69	1.98
Fort Collins Police Department	Larimer	CO	162	3	18.52	1.00
Grand Junction Police Department	Mesa	CO	108	2	18.52	1.36
Baltimore Police Department	Baltimore City	MD	2990	55	18.39	8.86
Colonie Town Police Department	Albany	NY	109	2	18.35	0.66
Florence Police Department	Florence	SC	109	2	18.35	1.46
New Haven Police Department	New Haven	CT	436	8	18.35	0.93
Durham Police Department	Durham	NC	494	9	18.22	3.36
Barnstable Police Department	Barnstable	MA	110	2	18.18	0.93
East Chicago Police	Lake	IN	110	2	18.18	0.40
Edmond Police Department	Oklahoma	OK	110	2	18.18	0.28
Richmond Police Department	Contra Costa	CA	165	3	18.18	0.29
Union City Police	Hudson	NJ	165	3	18.18	0.47
Norfolk Police Department	Norfolk City	VA	772	14	18.13	5.77
Gloucester Township Police	Camden	NJ	111	2	18.02	0.39
Palm Beach Gardens Police Department	Palm Beach	FL	114	2	17.54	0.15
Wilson Police Department	Wilson	NC	114	2	17.54	2.46
East Point Police Department	Fulton	GA	116	2	17.24	0.22
Manchester Police Department	Hartford	CT	116	2	17.24	0.22
Fayetteville Police Department	Washington	AR	117	2	17.09	0.98

Akron Police Department	Summit	OH	472	8	16.95	1.48
Bossier City Police Dept	Bossier	LA	178	3	16.85	2.56
Cleveland Police Department	Cuyahoga	OH	1616	27	16.71	2.11
Trenton Police	Mercer	NJ	361	6	16.62	1.64
Bloomington Police Dept	McLean	IL	122	2	16.39	1.18
West Haven Police Department	New Haven	CT	122	2	16.39	0.23
Broken Arrow Police Department	Tulsa	OK	124	2	16.13	0.33
Mission Police Department	Hidalgo	TX	125	2	16.00	0.26
Hattiesburg Police Department	Forrest	MS	126	2	15.87	2.67
Killeen Police Department	Bell	TX	190	3	15.79	0.97
Waterbury Police Department	New Haven	CT	256	4	15.63	0.46
Des Moines Police Department	Polk	IA	385	6	15.58	1.39
North Charleston Police Department	Charleston	SC	325	5	15.38	1.43
Somerville Police Department	Middlesex	MA	130	2	15.38	0.13
Sugar Land Police Department	Fort Bend	TX	130	2	15.38	0.34
Brockton Police Department	Plymouth	MA	197	3	15.23	0.61
Biloxi Police Department	Harrison	MS	133	2	15.04	1.07
Columbus Police Department	Muscogee	GA	400	6	15.00	3.16
San Antonio Police Department	Bexar	TX	2020	30	14.85	1.75
Ogden Police Department	Weber	UT	137	2	14.60	0.86
Gainesville Police Department	Alachua	FL	275	4	14.55	1.62
Billings Police Department	Yellowstone	MT	138	2	14.49	1.35
New Brunswick Police	Middlesex	NJ	138	2	14.49	0.25
Providence Police Department	Providence	RI	483	7	14.49	1.12
Santa Clara Police Department	Santa Clara	CA	141	2	14.18	0.11
Topeka Police Department	Shawnee	KS	283	4	14.13	2.25
Cherry Hill Police	Camden	NJ	145	2	13.79	0.39
Greeley Police Department	Weld	CO	146	2	13.70	0.79
Nashville Metro Police Department	Davidson	TN	1315	18	13.69	2.87
Dothan Police Department	Houston	AL	148	2	13.51	1.97
Fort Worth Police Department	Tarrant	TX	1489	20	13.43	1.11
St. Paul Police Department	Ramsey	MN	598	8	13.38	1.57
Louisville Metro Police Department	Jefferson	KY	1197	16	13.37	2.16
Jersey City Police	Hudson	NJ	900	12	13.33	1.89
Santa Fe Police Department	Santa Fe	NM	150	2	13.33	1.39
Tulsa Police Department	Tulsa	OK	826	11	13.32	1.82

Lubbock Police Department	Lubbock	TX	376	5	13.30	1.79
El Paso Police Department	El Paso	TX	1132	15	13.25	1.87
Oxnard Police Department	Ventura	CA	228	3	13.16	0.36
Lake Charles Police Department	Calcasieu	LA	153	2	13.07	1.04
Pawtucket Police Department	Providence	RI	153	2	13.07	0.32
Ocala Police Department	Marion	FL	155	2	12.90	0.60
Waukegan Police Dept	Lake	IL	155	2	12.90	0.28
Atlanta Police Department	Fulton	GA	1719	22	12.80	2.39
Albuquerque Police Department	Bernalillo	NM	1020	13	12.75	1.96
Vineland Police	Cumberland	NJ	157	2	12.74	1.27
Miami Police Department	Miami-Dade	FL	1104	14	12.68	0.56
Lansing Police Department	Ingham	MI	240	3	12.50	1.07
New Britain Police Department	Hartford	CT	160	2	12.50	0.22
Fort Lauderdale Police Department	Broward	FL	482	6	12.45	0.34
Lancaster Police Department	Lancaster	PA	161	2	12.42	0.39
Belleville Police Dept	St. Clair	IL	81	1	12.35	0.37
Downers Grove Police Dept	Du Page	IL	81	1	12.35	0.11
Sanford Police Department	Lee	NC	81	1	12.35	1.73
West Bloomfield Township Police Dept	Oakland	MI	81	1	12.35	0.08
Davie Police Department	Broward	FL	164	2	12.20	0.11
Mentor Police Department	Lake	OH	82	1	12.20	0.43
Alhambra Police Department	Los Angeles	CA	83	1	12.05	0.01
Citrus Heights Police Department	Sacramento	CA	83	1	12.05	0.07
Eules Police Department	Tarrant	TX	83	1	12.05	0.06
Garden Grove Police Department	Orange	CA	166	2	12.05	0.07
Gastonia Police Department	Gaston	NC	166	2	12.05	0.97
LaGrange Police Department	Troup	GA	83	1	12.05	1.49
North Brunswick Police	Middlesex	NJ	83	1	12.05	0.12
Montgomery Police Department	Montgomery	AL	500	6	12.00	2.62
Yuma Police Department	Yuma	AZ	167	2	11.98	1.02
Apopka Police Department	Orange	FL	85	1	11.76	0.09
Moline Police Department	Rock Island	IL	85	1	11.76	0.68
Pleasanton Police Department	Alameda	CA	85	1	11.76	0.07
Royal Oak Police Department	Oakland	MI	85	1	11.76	0.08
St. Petersburg Police Department	Pinellas	FL	510	6	11.76	0.65
Miramar Police Department	Broward	FL	171	2	11.70	0.11

Michigan City Police	La Porte	IN	86	1	11.63	0.90
Panama City Police Department	Bay	FL	86	1	11.63	0.59
Revere Police Department	Suffolk	MA	86	1	11.63	0.14
Salisbury Police Department	Rowan	NC	86	1	11.63	0.72
Washington Township Police	Gloucester	NJ	86	1	11.63	0.35
Dallas Police Department	Dallas	TX	3389	39	11.51	1.65
Oklahoma City Police Department	Oklahoma	OK	1046	12	11.47	1.67
Raleigh Police Department	Wake	NC	702	8	11.40	0.89
Jefferson City Police Department	Cole	MO	88	1	11.36	1.32
Salisbury Police Department	Wicomico	MD	88	1	11.36	1.01
Titusville Police Department	Brevard	FL	88	1	11.36	0.18
Wichita Falls Police Department	Wichita	TX	177	2	11.30	1.52
Idaho Falls Police Department	Bonneville	ID	89	1	11.24	0.96
Lynn Police Department	Essex	MA	178	2	11.24	0.27
Utica Police Department	Oneida	NY	179	2	11.17	0.85
Grapevine Police Department	Tarrant	TX	90	1	11.11	0.06
Kennewick Police Department	Benton	WA	90	1	11.11	0.57
New Bern Police Department	Craven	NC	90	1	11.11	0.97
Orangetown Town Police Department	Rockland	NY	90	1	11.11	0.32
Orem Department of Public Safety	Utah	UT	90	1	11.11	0.19
Piscataway Township Police	Middlesex	NJ	90	1	11.11	0.12
West Chester Police Department	Butler	OH	90	1	11.11	0.27
Virginia Beach Police Department	Virginia Beach City	VA	813	9	11.07	2.05
Calumet City Police Dept	Cook	IL	91	1	10.99	0.02
McAllen Police Department	Hidalgo	TX	273	3	10.99	0.39
Bellevue Police Dept	Sarpy	NE	92	1	10.87	0.63
Chelsea Police Department	Suffolk	MA	92	1	10.87	0.14
Coral Gables Police Department	Miami-Dade	FL	184	2	10.87	0.08
Joplin Police Department	Jasper	MO	92	1	10.87	0.85
Saginaw Police Department	Saginaw	MI	92	1	10.87	0.50
Wilkes Barre City Police Department	Luzerne	PA	92	1	10.87	0.31
Evansville Police	Vanderburgh	IN	277	3	10.83	1.67
New Rochelle Police Department	Westchester	NY	185	2	10.81	0.21
Portland Police Bureau	Multnomah	OR	928	10	10.78	1.36
Anchorage Police Department	Anchorage	AK	372	4	10.75	1.37
College Park Police Department	Fulton	GA	93	1	10.75	0.11

Haverhill Police Department	Essex	MA	93	1	10.75	0.13
Palm Springs Police Department	Riverside	CA	93	1	10.75	0.05
Palo Alto Police Department	Santa Clara	CA	93	1	10.75	0.06
Florence Police Department	Lauderdale	AL	94	1	10.64	1.08
Texarkana Police Department	Bowie	TX	94	1	10.64	1.08
East Orange Police	Essex	NJ	283	3	10.60	0.38
Orlando Police Department	Orange	FL	757	8	10.57	0.70
Irvington Police	Essex	NJ	190	2	10.53	0.26
San Marcos Police Department	Hays	TX	95	1	10.53	0.64
Eau Claire Police Department	Eau Claire	WI	96	1	10.42	1.01
Weymouth Police Department	Norfolk	MA	96	1	10.42	0.15
Riverside Police Department	Riverside	CA	385	4	10.39	0.18
Worcester Police Department	Worcester	MA	482	5	10.37	0.63
Stamford Police Department	Fairfield	CT	292	3	10.27	0.33
Detroit Police Department	Wayne	MI	2250	23	10.22	1.26
East Providence Police Department	Providence	RI	98	1	10.20	0.16
Cedar Rapids Police Department	Linn	IA	197	2	10.15	0.95
Redondo Beach Police Department	Los Angeles	CA	99	1	10.10	0.01
Rogers Police Department	Benton	AR	99	1	10.10	0.45
Euclid Police Department	Cuyahoga	OH	100	1	10.00	0.08
Kokomo Police	Howard	IN	100	1	10.00	1.21
Missoula Police Department	Missoula	MT	100	1	10.00	0.91
Philadelphia Police Department	Philadelphia	PA	6624	66	9.96	4.33
Joliet Police Dept	Will	IL	302	3	9.93	0.44
Goldsboro Police Department	Wayne	NC	101	1	9.90	0.82
Birmingham Police Department	Jefferson	AL	816	8	9.80	1.21
Des Plaines Police Dept	Cook	IL	102	1	9.80	0.02
Jupiter Police Department	Palm Beach	FL	102	1	9.80	0.08
Southampton Town Police Department	Suffolk	NY	102	1	9.80	0.07
Springfield Police Dept	Greene	MO	306	3	9.80	1.09
Lakewood Police Department	Pierce	WA	103	1	9.71	0.13
Oro Valley Police Department	Pima	AZ	103	1	9.71	0.10
West Palm Beach Police Department	Palm Beach	FL	310	3	9.68	0.23
Bensalem Township Police Department	Bucks	PA	104	1	9.62	0.16
Aurora Police Department	Arapahoe	CO	627	6	9.57	1.05
Alexandria Police Department	Alexandria City	VA	315	3	9.52	2.14

Bartlett Police Department	Shelby	TN	105	1	9.52	0.11
Baton Rouge Police Department	East Baton Rouge	LA	630	6	9.52	1.36
Broomfield Police Department	Broomfield	CO	105	1	9.52	1.79
Council Bluffs Police Department	Pottawattomie	IA	105	1	9.52	1.07
Hagerstown Police Department	Washington	MD	105	1	9.52	0.68
Merced Police Department	Merced	CA	105	1	9.52	0.39
Newburgh City Police Department	Orange	NY	105	1	9.52	0.27
Poughkeepsie Police Department	Dutchess	NY	105	1	9.52	0.34
Oak Lawn Police Dept	Cook	IL	106	1	9.43	0.02
Ocean City Police Department	Worcester	MD	107	1	9.35	1.94
O'Fallon Police Department	St. Charles	MO	107	1	9.35	0.28
Richmond Police Department	Richmond City	VA	752	7	9.31	3.43
Laredo Police Department	Webb	TX	430	4	9.30	1.60
Cincinnati Police Department	Hamilton	OH	1082	10	9.24	1.25
Cape Coral Police Department	Lee	FL	220	2	9.09	0.32
Medford Police Department	Middlesex	MA	110	1	9.09	0.07
Milford Police Department	New Haven	CT	110	1	9.09	0.12
Sandy Police Department	Salt Lake	UT	110	1	9.09	0.10
York Police Department	York	PA	110	1	9.09	0.23
Vacaville Police Department	Solano	CA	111	1	9.01	0.24
Fort Wayne Police	Allen	IN	447	4	8.95	1.13
Covington Police Department	Kenton	KY	112	1	8.93	0.63
Hempstead Village Police Department	Nassau	NY	112	1	8.93	0.07
St. Charles Police Dept	St. Charles	MO	112	1	8.93	0.28
Daly City Police Department	San Mateo	CA	113	1	8.85	0.14
Flagstaff Police Department	Coconino	AZ	113	1	8.85	0.74
Meriden Police Department	New Haven	CT	113	1	8.85	0.12
Hickory Police Department	Catawba	NC	114	1	8.77	0.65
St. Joseph Police Dept	Buchanan	MO	114	1	8.77	1.12
Charlottesville Police Dept.	Charlottesville City	VA	115	1	8.70	2.30
Lauderhill Police Department	Broward	FL	115	1	8.70	0.06
Oak Park Police Dept	Cook	IL	115	1	8.70	0.02
Ottawa County Sheriff's Office	Ottawa	MI	115	1	8.70	0.38
Tupelo Police Department	Lee	MS	115	1	8.70	1.21
Hampton Police Department	Hampton City	VA	232	2	8.62	1.46
Wayne Township Police	Passaic	NJ	117	1	8.55	0.20

Denver Police Department	Denver	CO	1525	13	8.52	2.17
Framingham Police Department	Middlesex	MA	118	1	8.47	0.07
Redding Police Department	Shasta	CA	118	1	8.47	0.56
Fresno Police Department	Fresno	CA	828	7	8.45	0.75
Greensboro Police Department	Guilford	NC	593	5	8.43	1.02
Bristol Police Department	Hartford	CT	119	1	8.40	0.11
West New York Police	Hudson	NJ	119	1	8.40	0.16
Lowell Police Department	Middlesex	MA	239	2	8.37	0.13
El Cajon Police Department	San Diego	CA	120	1	8.33	0.03
Ramapo Town Police Department	Rockland	NY	120	1	8.33	0.32
Reno Police Department	Washoe	NV	362	3	8.29	0.71
Rock Hill Police Department	York	SC	121	1	8.26	0.44
Troy Police Department	Rensselaer	NY	121	1	8.26	0.63
Champaign Police Dept	Champaign	IL	122	1	8.20	0.50
Beaumont Police Department	Jefferson	TX	246	2	8.13	0.79
Harlingen Police Department	Cameron	TX	123	1	8.13	0.25
Holyoke Police Department	Hampden	MA	123	1	8.13	0.22
North Bergen Police	Hudson	NJ	123	1	8.13	0.16
Tacoma Police Department	Pierce	WA	371	3	8.09	0.38
Altamonte Springs Police Department	Seminole	FL	124	1	8.06	0.24
Beaverton Police Department	Washington	OR	124	1	8.06	0.19
Omaha Police Dept	Douglas	NE	747	6	8.03	1.16
Miami Beach Police Department	Miami-Dade	FL	374	3	8.02	0.12
Rochester Police Department	Olmsted	MN	125	1	8.00	0.69
Chesapeake Police Department	Chesapeake City	VA	376	3	7.98	1.35
Danville Police Department	Pittsylvania	VA	126	1	7.94	1.57
Elk Grove Police Department	Sacramento	CA	126	1	7.94	0.38
Brick Township Police	Ocean	NJ	127	1	7.87	0.17
Springfield Police Department	Clark	OH	127	1	7.87	0.72
Surprise Police Department	Maricopa	AZ	127	1	7.87	0.03
Lafayette Police	Tippecanoe	IN	128	1	7.81	0.58
Mobile Police Department	Mobile	AL	515	4	7.77	0.97
Gresham Police Department	Multnomah	OR	129	1	7.75	0.14
Washington Metropolitan Police Dept	District of Columbia	DC	3742	29	7.75	4.82
Sanford Police Department	Seminole	FL	131	1	7.63	0.24
Roanoke City Police Department	Roanoke City	VA	264	2	7.58	2.06

Anaheim Police Department	Orange	CA	398	3	7.54	0.10
Chicopee Police Department	Hampden	MA	133	1	7.52	0.22
Decatur Police Department	Morgan	AL	133	1	7.52	0.84
Federal Way Police Department	King	WA	133	1	7.52	0.05
Marietta Police Department	Cobb	GA	133	1	7.52	0.15
Round Rock Police Department	Williamson	TX	133	1	7.52	0.24
Valdosta Police Department	Lowndes	GA	133	1	7.52	0.92
Wilmington Police Department	New Hanover	NC	266	2	7.52	0.99
Colorado Springs Police Department	El Paso	CO	668	5	7.49	0.80
Yakima Police Department	Yakima	WA	134	1	7.46	0.41
Hamilton Police Department	Butler	OH	135	1	7.41	0.27
Huntsville Police Department	Madison	AL	405	3	7.41	0.90
St. Louis (city) Police Dept	St. Louis City	MO	1351	10	7.40	3.13
Baytown Police Department	Harris	TX	136	1	7.35	0.02
Longmont Police Department	Boulder	CO	136	1	7.35	0.34
Newton Police Department	Middlesex	MA	136	1	7.35	0.07
Santa Barbara Police Department	Santa Barbara	CA	136	1	7.35	0.24
Visalia Department of Public Safety	Tulare	CA	136	1	7.35	0.23
Mount Pleasant Police Department	Charleston	SC	137	1	7.30	0.29
Frederick Police Department	Frederick	MD	138	1	7.25	0.43
Jacksonville Sheriff's Office	Duval	FL	1662	12	7.22	1.39
Binghamton Police Department	Broome	NY	139	1	7.19	0.50
Largo Police Department	Pinellas	FL	140	1	7.14	0.11
Newport Beach Police Department	Orange	CA	140	1	7.14	0.03
Pine Bluff Police Department	Jefferson	AR	140	1	7.14	1.29
Sacramento Police Department	Sacramento	CA	701	5	7.13	0.35
Bridgeport Police Department	Fairfield	CT	422	3	7.11	0.33
Seattle Police Department	King	WA	1283	9	7.01	0.47
Rocky Mount Police Department	Nash	NC	143	1	6.99	1.77
New Bedford Police Department	Bristol	MA	288	2	6.94	0.36
Houston Police Department	Harris	TX	5053	35	6.93	0.86
Johnson City Police Department	Washington	TN	146	1	6.85	0.81
Pensacola Police Department	Escambia	FL	146	1	6.85	0.34
Corpus Christi Police Department	Nueces	TX	448	3	6.70	0.88
Austin Police Department	Travis	TX	1515	10	6.60	0.98
Delray Beach Police Department	Palm Beach	FL	152	1	6.58	0.08

Boise Police Department	Ada	ID	306	2	6.54	0.51
Concord Police Department	Cabarrus	NC	153	1	6.54	0.56
Danbury Police Department	Fairfield	CT	153	1	6.54	0.11
Midland Police Department	Midland	TX	153	1	6.54	0.73
Wilmington Police Department	New Castle	DE	306	2	6.54	0.37
San Jose Police Department	Santa Clara	CA	1382	9	6.51	0.51
Columbia Police Department	Boone	MO	155	1	6.45	0.61
Denton Police Department	Denton	TX	155	1	6.45	0.15
Harrisburg Police Department	Dauphin	PA	155	1	6.45	0.37
Boston Police Department	Suffolk	MA	2181	14	6.42	1.94
Clifton Police	Passaic	NJ	158	1	6.33	0.20
Costa Mesa Police Department	Orange	CA	158	1	6.33	0.03
Palm Bay Police Department	Brevard	FL	159	1	6.29	0.18
Chicago Police Dept	Cook	IL	13354	83	6.22	1.60
Concord Police Department	Contra Costa	CA	161	1	6.21	0.10
Galveston Police Department	Galveston	TX	161	1	6.21	0.34
Olathe Police Department	Johnson	KS	161	1	6.21	0.18
Kenner Police Department	Jefferson	LA	162	1	6.17	0.23
San Diego Police Department	San Diego	CA	1951	12	6.15	0.39
Melbourne Police Department	Brevard	FL	163	1	6.13	0.18
Syracuse Police Department	Onondaga	NY	489	3	6.13	0.64
Newark Police	Essex	NJ	1310	8	6.11	1.02
Boulder Police Department	Boulder	CO	165	1	6.06	0.34
Lawton Police Department	Comanche	OK	165	1	6.06	0.81
Paterson Police	Passaic	NJ	497	3	6.04	0.60
Decatur Police Dept	Macon	IL	166	1	6.02	0.90
Chandler Police Department	Maricopa	AZ	333	2	6.01	0.05
Erie Police Department	Erie	PA	167	1	5.99	0.36
Las Cruces Police Department	Dona Ana	NM	167	1	5.99	0.48
Henderson Police Department	Clark	NV	336	2	5.95	0.10
Winston-Salem Police Department	Forsyth	NC	508	3	5.91	0.86
Fayetteville Police Department	Cumberland	NC	341	2	5.87	0.63
Suffolk Police Department	Suffolk	VA	171	1	5.85	1.18
Canton Police Department	Stark	OH	172	1	5.81	0.27
Irving Police Department	Dallas	TX	344	2	5.81	0.08
Nashua Police Department	Hillsborough	NH	172	1	5.81	0.25

Tucson Police Department	Pima	AZ	1032	6	5.81	0.61
San Bernardino Police Department	San Bernardino	CA	345	2	5.80	0.10
Sunrise Police Department	Broward	FL	175	1	5.71	0.06
Fremont Police Department	Alameda	CA	182	1	5.49	0.07
New York City Police Department	New York	NY	36023	196	5.44	2.40
Naperville Police Dept	Du Page	IL	184	1	5.43	0.11
Hayward Police Department	Alameda	CA	185	1	5.41	0.07
Berkeley Police Department	Alameda	CA	186	1	5.38	0.07
West Valley City Police Department	Salt Lake	UT	186	1	5.38	0.10
Inglewood Police Department	Los Angeles	CA	187	1	5.35	0.01
Salem Police Department	Marion	OR	187	1	5.35	0.32
Monroe Police Department	Ouachita	LA	188	1	5.32	0.65
Peoria Police Department	Maricopa	AZ	189	1	5.29	0.03
Charleston Police Department	Charleston	SC	382	2	5.24	0.57
Gulfport Police Department	Harrison	MS	193	1	5.18	0.53
Racine Police Department	Racine	WI	195	1	5.13	0.51
Irvine Police Department	Orange	CA	197	1	5.08	0.03
Everett Police Department	Snohomish	WA	198	1	5.05	0.14
Buffalo Police Department	Erie	NY	793	4	5.04	0.44
Phoenix Police Department	Maricopa	AZ	3388	17	5.02	0.45
Allentown Police Department	Lehigh	PA	200	1	5.00	0.29
Arlington Police Department	Tarrant	TX	610	3	4.92	0.17
Mount Vernon Police Department	Westchester	NY	205	1	4.88	0.11
Quincy Police Department	Norfolk	MA	205	1	4.88	0.15
Independence Police Department	Jackson	MO	206	1	4.85	0.15
Woodbridge Police	Middlesex	NJ	206	1	4.85	0.12
Stockton Police Department	San Joaquin	CA	415	2	4.82	0.29
Columbus Police Department	Franklin	OH	1886	9	4.77	0.77
White Plains Police Department	Westchester	NY	210	1	4.76	0.11
Manchester Police Department	Hillsborough	NH	218	1	4.59	0.25
Sioux Falls Police Department	Minnehaha	SD	221	1	4.52	0.59
Huntington Beach Police Department	Orange	CA	223	1	4.48	0.03
Mesquite Police Department	Dallas	TX	226	1	4.42	0.04
Brownsville Police Department	Cameron	TX	230	1	4.35	0.25
Warren Police Department	Macomb	MI	230	1	4.35	0.12
Rochester Police Department	Monroe	NY	703	3	4.27	0.40

North Las Vegas Police Department	Clark	NV	471	2	4.25	0.10
Fall River Police Department	Bristol	MA	237	1	4.22	0.18
Pembroke Pines Police Department	Broward	FL	238	1	4.20	0.06
Long Beach Police Department	Los Angeles	CA	968	4	4.13	0.04
Lafayette Police Department	Lafayette	LA	243	1	4.12	0.45
Chula Vista Police Department	San Diego	CA	244	1	4.10	0.03
Kalamazoo Dept of Public Safety	Kalamazoo	MI	244	1	4.10	0.40
Port St. Lucie Police Department	St. Lucie	FL	245	1	4.08	0.36
Peoria Police Dept	Peoria	IL	246	1	4.07	0.54
Clearwater Police Department	Pinellas	FL	255	1	3.92	0.11
Oakland Police Department	Alameda	CA	773	3	3.88	0.20
Little Rock Police Department	Pulaski	AR	520	2	3.85	0.52
Tuscaloosa Police Department	Tuscaloosa	AL	263	1	3.80	0.51
Glendale Police Department	Los Angeles	CA	264	1	3.79	0.01
Cambridge Police Department	Middlesex	MA	272	1	3.68	0.07
Springfield Police Dept	Sangamon	IL	273	1	3.66	0.51
San Francisco Police Department	San Francisco	CA	1940	7	3.61	0.87
Kansas City Police Department	Jackson	MO	1421	5	3.52	0.74
Rockford Police Dept	Winnebago	IL	300	1	3.33	0.34
Lincoln Police Dept	Lancaster	NE	308	1	3.25	0.35
Grand Rapids Police Department	Kent	MI	319	1	3.13	0.17
Yonkers Police Department	Westchester	NY	641	2	3.12	0.21
Los Angeles Police Department	Los Angeles	CA	9727	30	3.08	0.31
Tampa Police Department	Hillsborough	FL	980	3	3.06	0.24
Wichita Police Department	Sedgwick	KS	662	2	3.02	0.40
Hialeah Police Department	Miami-Dade	FL	338	1	2.96	0.04
Plano Police Department	Collin	TX	343	1	2.92	0.13
Salt Lake County Sheriff's Office	Salt Lake	UT	342	1	2.92	0.10
Elizabeth Police	Union	NJ	348	1	2.87	0.19
Tempe Police Department	Maricopa	AZ	357	1	2.80	0.03
Tallahassee Police Department	Leon	FL	364	1	2.75	0.36
Las Vegas Metro Police Department	Clark	NV	2942	8	2.72	0.41
Mesa Police Department	Maricopa	AZ	831	2	2.41	0.05
Scottsdale Police Dept	Maricopa	AZ	417	1	2.40	0.03
Dayton Police Department	Montgomery	OH	421	1	2.38	0.19
Salt Lake City Police Department	Salt Lake	UT	433	1	2.31	0.10

Madison Police Department	Dane	WI	437	1	2.29	0.20
---------------------------	------	----	-----	---	------	------

Appendix B-7. Special State & Local Law Enforcement Agencies in Study: Rates of Officers Arrested, 2005-2011 (Sorted by Rate per 1,000 Officers)

Agency	County	State	# of Full-Time Sworn Personnel	Per Agency	Per 1,000 Officers	Per 100,000 Population
Connally I.S.D. Police Dept.	McLennan	TX	3	1	333.33	0.43
Santa Rosa I.S.D. Police Department	Cameron	TX	3	1	333.33	0.25
Grambling State University Police Dept.	Lincoln	LA	9	2	222.22	4.28
Ennis I.S.D. Police Department	Ellis	TX	5	1	200.00	0.67
Ventura College	Ventura	CA	5	1	200.00	0.12
California Exposition And State Fair Police	Sacramento	CA	6	1	166.67	0.07
Lancaster I.S.D. Police Dept.	Dallas	TX	6	1	166.67	0.04
University of Maryland Eastern Shore Public Safety	Somerset	MD	6	1	166.67	3.78
University of West Alabama Police	Sumter	AL	6	1	166.67	7.27
Greenville Technical College Public Safety	Greenville	SC	9	1	111.11	0.22
Lehigh-Northampton Airport Auth. Police Dept	Lehigh	PA	9	1	111.11	0.29
BYU-Idaho Police Department	Madison	ID	10	1	100.00	2.66
Lander University Public Safety	Greenwood	SC	10	1	100.00	1.44
Santa Ana Unified School District Police Dept.	Orange	CA	21	2	95.24	0.07
Midland I.S.D. Police Dept.	Midland	TX	11	1	90.91	0.73
Missouri Univ. of Science & Technology Police Dept	Phelps	MO	11	1	90.91	2.21
Morrisville State College Police	Madison	NY	11	1	90.91	1.36
University of South Carolina - Upstate Police Dept	Spartanburg	SC	12	1	83.33	0.35
College of Lake County Police Dept	Lake	IL	13	1	76.92	0.14
Missouri Department of Corrections	Cole	MO	13	1	76.92	1.32
University of Pittsburgh at Johnstown Police	Cambria	PA	13	1	76.92	0.70
Tennessee State University	Davidson	TN	27	2	74.07	0.32
Bowie State University Dept. of Public Safety	Prince Georges	MD	14	1	71.43	0.12
St. Edward's University Police Department	Travis	TX	14	1	71.43	0.10
University of Colorado - Colorado Springs Police Dept.	El Paso	CO	14	1	71.43	0.16
Kentucky Alcoholic Beverage Control	Franklin	KY	30	2	66.67	0.27
Arkansas State University Police Dept.	Craighead	AR	17	1	58.82	1.04
Shippensburg University of Pennsylvania Police	Cumberland	PA	17	1	58.82	0.42
St. Joseph County Airport Police	St. Joseph	IN	17	1	58.82	0.37
Indiana University Purdue U. Fort Wayne U. Police	Allen	IN	18	1	55.56	0.28
Lafayette College Office of Public Safety	Northampton	PA	18	1	55.56	0.34

Georgia Public Safety Training Center	Monroe	GA	19	1	52.63	3.78
Massachusetts Dept of Mental Health Police Dept	Suffolk	MA	40	2	50.00	0.28
St. Mary's University Police Department	Bexar	TX	20	1	50.00	0.06
Central Michigan University Police Department	Isabella	MI	21	1	47.62	1.42
North Forest I.S.D. Police Dept.	Harris	TX	21	1	47.62	0.02
Beaumont I.S.D. Police Dept.	Jefferson	TX	22	1	45.45	0.40
Humble I.S.D. Police Dept.	Harris	TX	24	1	41.67	0.02
Appalachian State University Police Dept	Watauga	NC	25	1	40.00	1.96
University of Tennessee at Knoxville Police	Knox	TN	52	2	38.46	10.47
Dayton International Airport Police Dept	Montgomery	OH	29	1	34.48	0.19
Buffalo State College Police	Erie	NY	30	1	33.33	0.11
Cameron Co. District Attorney Investigations Div	Cameron	TX	30	1	33.33	0.25
Houston Baptist University Police Department	Harris	TX	30	1	33.33	0.02
Ohio Department of Taxation - Enforcement Division	Franklin	OH	30	1	33.33	0.18
Socorro I.S.D. Police Dept.	El Paso	TX	30	1	33.33	0.12
Volusia County Beach Patrol	Volusia	FL	60	2	33.33	0.40
Medical College of Georgia	Richmond	GA	32	1	31.25	0.50
Tuskegee University Police Department	Macon	AL	33	1	30.30	4.66
University of Arkansas Medical Sciences Dept of Pub	Pulaski	AR	36	1	27.78	0.26
California Bureau of Narcotics Enforcement	Sacramento	CA	73	2	27.40	0.02
Virginia Commonwealth University Police Dept.	Richmond City	VA	74	2	27.03	0.98
San Antonio Park Rangers	Bexar	TX	112	3	26.79	0.17
Florida Atlantic University Police	Palm Beach	FL	39	1	25.64	0.08
Florida International University Police	Miami-Dade	FL	39	1	25.64	0.04
Kansas State Law Enforcement Training Center	Reno	KS	39	1	25.64	0.20
University of North Texas Police Department	Denton	TX	40	1	25.00	0.15
State University at Albany Police	Albany	NY	41	1	24.39	0.33
Northside I.S.D. Police Dept.	Bexar	TX	83	2	24.10	0.12
Allegheny Port Authority Transit Police	Allegheny	PA	42	1	23.81	0.08
McAllen I.S.D. Police Dept.	Hidalgo	TX	43	1	23.26	0.13
Southern University and A & M College Police	East Baton Rouge	LA	43	1	23.26	0.23
Palm Beach County School District Police	Palm Beach	FL	176	4	22.73	0.30
Houston Community College System	Harris	TX	48	1	20.83	0.02
Louisiana State Univ. Health Sciences Center Police Dept	Caddo	LA	49	1	20.41	0.39
Wayne State University Dept of Public Safety	Wayne	MI	49	1	20.41	0.05
Delaware River & Bay Authority Police	New Castle	DE	50	1	20.00	0.51

Ohio State University Police Department	Franklin	OH	51	1	19.61	0.09
United I.S.D. Police Dept.	Webb	TX	51	1	19.61	0.40
George Mason University Police Dept.	Fairfax	VA	52	1	19.23	0.09
University of Illinois Police Dept	Champaign	IL	54	1	18.52	0.50
University of California - Los Angeles Police	Los Angeles	CA	57	1	17.54	0.01
MIT Police Department	Middlesex	MA	59	1	16.95	0.07
Northern Illinois University Police	DeKalb	IL	59	1	16.95	0.95
Duke University Police Department	Durham	NC	60	1	16.67	0.37
Virginia Marine Resources Commission	Newport News City	VA	60	1	16.67	3.02
Louisiana State University Police Department	East Baton Rouge	LA	62	1	16.13	0.23
Medical University of South Carolina Public Safety	Charleston	SC	62	1	16.13	0.29
University of Texas - Austin Police	Travis	TX	62	1	16.13	0.10
Anchorage International Airport Police	Anchorage	AK	65	1	15.38	0.34
New Jersey Transit Police	Essex	NJ	201	3	14.93	0.47
Georgia State University Police	Fulton	GA	68	1	14.71	0.11
Maryland Department of General Services Police	Baltimore City	MD	68	1	14.71	0.16
Austin I.S.D. Police Department	Travis	TX	70	1	14.29	0.10
University of Pittsburgh - Main Campus Police	Allegheny	PA	73	1	13.70	0.08
University of Alabama - Birmingham Police Dept	Jefferson	AL	79	1	12.66	0.15
Boston School Police	Suffolk	MA	80	1	12.50	0.14
Middlesex County Prosecutor's Office	Middlesex	NJ	80	1	12.50	0.12
University of Florida Police	Alachua	FL	85	1	11.76	0.40
Maryland National Capital Park Police - Montgomery Co	Montgomery	MD	86	1	11.63	0.41
Dallas I.S.D. Police Dept.	Dallas	TX	88	1	11.36	0.04
Indiana State Excise Police	Marion	IN	88	1	11.36	0.11
New Jersey Department of Environmental Protection	Burlington	NJ	90	1	11.11	0.11
Vanderbilt University Police Department	Davidson	TN	91	1	10.99	0.16
Wisconsin Dept of Justice - Criminal Investigation Div.	Dane	WI	92	1	10.87	0.20
New Mexico Department Of Game & Fish	Santa Fe	NM	106	1	9.43	0.69
South Carolina Dept of Mental Health-Public Safety	Richland	SC	120	1	8.33	0.26
MBTA Transit Police	Suffolk	MA	256	2	7.81	0.28
Pennsylvania Dept of Conservation & Natural Resources	Dauphin	PA	136	1	7.35	0.79
Maryland Transit Administration Police	Baltimore City	MD	140	1	7.14	0.16
Baltimore City School Police Dept.	Baltimore City	MD	142	1	7.04	0.16
Delaware River Port Authority - Transit Police	Camden	NJ	144	1	6.94	0.19
Florida Fish & Wildlife Conservation Commission	Leon	FL	626	4	6.39	0.44

New York City Dept of Environmental Protection Police	Westchester	NY	168	1	5.95	1.29
Los Angeles School Police Department	Los Angeles	CA	340	2	5.88	0.02
BART Police Department	Alameda	CA	192	1	5.21	0.07
Ohio Dept of Natural Resources - Ofc. of Law Enf.	Franklin	OH	394	2	5.08	3.24
Metropolitan Washington Airports Authority Police	Arlington	VA	206	1	4.85	0.09
Washington Metropolitan Area Transit Auth. Police	District of Columbia	DC	442	2	4.52	0.33
Maryland Natural Resources Police	Anne Arundel	MD	224	1	4.46	0.19
Mississippi Department of Wildlife, Fisheries & Parks	Hinds	MS	230	1	4.35	1.05
South Carolina Department of Natural Resources	Richland	SC	238	1	4.20	0.26
Texas Alcoholic Beverage Commission	Travis	TX	277	1	3.61	0.10
New York State Park Police	Albany	NY	305	1	3.28	0.21
New York State Metro Transportation Auth. Police	New York	NY	694	2	2.88	0.13
California Dept. of Justice	Sacramento	CA	419	1	2.39	0.10
School District of Philadelphia Police	Philadelphia	PA	450	1	2.22	0.07
Maryland Transportation Authority Police	Baltimore	MD	456	1	2.19	0.16
District of Columbia Protective Services Police	District of Columbia	DC	484	1	2.07	0.17
Port Authority of New York & New Jersey Police Dept	Hudson	NJ	1667	1	0.60	0.16

Appendix C-1. 200 Largest State & Local Law Enforcement Agencies in Study: Rates of Officers Arrested, 2005-2011 (Sorted by Rate per 100,000 Population)

Agency	County	State	# of Full-Time Sworn Personnel	Per Agency	Per 1,000 Officers	Per 100,000 Population
New Orleans Police Department	Orleans	LA	1425	63	44.21	18.32
Baltimore Police Department	Baltimore City	MD	2990	55	18.39	8.86
Milwaukee Police Department	Milwaukee	WI	1987	73	36.74	7.70
Norfolk Police Department	Norfolk City	VA	772	14	18.13	5.77
Memphis Police Department	Shelby	TN	1549	46	29.70	4.96
Washington Metropolitan Police Department	DC	DC	3742	29	7.75	4.82
Shreveport Police Department	Caddo	LA	511	12	23.48	4.71
Philadelphia Police Department	Philadelphia	PA	6624	66	9.96	4.33
Jackson Police Department	Hinds	MS	480	9	18.75	3.67
Indianapolis Police	Marion	IN	1582	33	20.86	3.65
Richmond Police Department	Richmond City	VA	752	7	9.31	3.43
Durham Police Department	Durham	NC	494	9	18.22	3.36
St. Louis (city) Police Dept	St. Louis City	MO	1351	10	7.40	3.13
Nashville Metro Police Department	Davidson	TN	1315	18	13.69	2.87
Jefferson Parish Sheriff's Office	Jefferson	LA	825	12	14.55	2.77
Honolulu (City & County) Police Department	Honolulu	HI	1934	26	13.44	2.73
Toledo Police Department	Lucas	OH	640	12	18.75	2.72
Montgomery Police Department	Montgomery	AL	500	6	12.00	2.62
Richmond County Sheriff's Office	Richmond	GA	449	5	11.14	2.49
New York City Police Department	New York	NY	36023	196	5.44	2.40
Atlanta Police Department	Fulton	GA	1719	22	12.80	2.39
Savannah-Chatham Metropolitan Police Dept	Chatham	GA	534	6	11.24	2.26
Prince George's County Police Department	Prince Georges	MD	1578	19	12.04	2.20
Charlotte - Mecklenburg Police Department	Mecklenburg	NC	1672	20	11.96	2.17
Denver Police Department	Denver	CO	1525	13	8.52	2.17
Polk County Sheriff's Office	Polk	FL	600	13	21.67	2.16
Louisville Metro Police Department	Jefferson	KY	1197	16	13.37	2.16
Cleveland Police Department	Cuyahoga	OH	1616	27	16.71	2.11
Virginia Beach Police Department	VA Beach City	VA	813	9	11.07	2.05
Albuquerque Police Department	Bernalillo	NM	1020	13	12.75	1.96
Springfield Police Department	Hampden	MA	464	9	19.40	1.94

Boston Police Department	Suffolk	MA	2181	14	6.42	1.94
Jersey City Police	Hudson	NJ	900	12	13.33	1.89
DeKalb County Police Department	DeKalb	GA	1074	13	12.10	1.88
El Paso Police Department	El Paso	TX	1132	15	13.25	1.87
Collier County Sheriff's Office	Collier	FL	628	6	9.55	1.87
Tulsa Police Department	Tulsa	OK	826	11	13.32	1.82
San Antonio Police Department	Bexar	TX	2020	30	14.85	1.75
Pittsburgh Police Department	Allegheny	PA	891	21	23.57	1.72
Oklahoma City Police Department	Oklahoma	OK	1046	12	11.47	1.67
Montgomery County Police Department	Montgomery	MD	1206	16	13.27	1.65
Dallas Police Department	Dallas	TX	3389	39	11.51	1.65
Chicago Police Department	Cook	IL	13354	83	6.22	1.60
St. Paul Police Department	Ramsey	MN	598	8	13.38	1.57
Minneapolis Police Department	Hennepin	MN	902	18	19.96	1.56
Akron Police Department	Summit	OH	472	8	16.95	1.48
Orange County Sheriff's Office	Orange	FL	1398	16	11.44	1.40
Jacksonville Sheriff's Office	Duval	FL	1662	12	7.22	1.39
Portland Police Bureau	Multnomah	OR	928	10	10.78	1.36
Baton Rouge Police Department	E. Baton Rouge	LA	630	6	9.52	1.36
Kern County Sheriff's Office	Kern	CA	512	11	21.48	1.31
Henrico County Division of Police	Henrico	VA	554	4	7.22	1.30
Detroit Police Department	Wayne	MI	2250	23	10.22	1.26
Cincinnati Police Department	Hamilton	OH	1082	10	9.24	1.25
Manatee County Sheriff's Office	Manatee	FL	476	4	8.40	1.24
Birmingham Police Department	Jefferson	AL	816	8	9.80	1.21
Passaic County Sheriff's Office	Passaic	NJ	530	6	11.32	1.20
Omaha Police Dept	Douglas	NE	747	6	8.03	1.16
Orleans Parish Sheriff's Office (Criminal Division)	Orleans	LA	505	4	7.92	1.16
Lee County Sheriff's Office	Lee	FL	621	7	11.27	1.13
Fort Wayne Police	Allen	IN	447	4	8.95	1.13
Providence Police Department	Providence	RI	483	7	14.49	1.12
Fort Worth Police Department	Tarrant	TX	1489	20	13.43	1.11
Leon County Sheriff's Office	Leon	FL	443	3	6.77	1.09
Aurora Police Department	Arapahoe	CO	627	6	9.57	1.05
Greensboro Police Department	Guilford	NC	593	5	8.43	1.02
Newark Police	Essex	NJ	1310	8	6.11	1.02

Miami-Dade (County) Police Department	Miami-Dade	FL	3093	25	8.08	1.00
Austin Police Department	Travis	TX	1515	10	6.60	0.98
Mobile Police Department	Mobile	AL	515	4	7.77	0.97
Broward County Sheriff's Office	Broward	FL	1624	16	9.85	0.92
Palm Beach County Sheriff's Office	Palm Beach	FL	1447	12	8.29	0.91
Raleigh Police Department	Wake	NC	702	8	11.40	0.89
Corpus Christi Police Department	Nueces	TX	448	3	6.70	0.88
Pinellas County Sheriff's Office	Pinellas	FL	863	8	9.27	0.87
San Francisco Police Department	San Francisco	CA	1940	7	3.61	0.87
Shelby County Sheriff's Office	Shelby	TN	516	8	15.50	0.86
Pasco County Sheriff's Office	Pasco	FL	485	4	8.25	0.86
Houston Police Department	Harris	TX	5053	35	6.93	0.86
Winston-Salem Police Department	Forsyth	NC	508	3	5.91	0.86
Denver County Sheriff's Office	Denver	CO	739	5	6.77	0.83
Volusia County Sheriff's Office	Volusia	FL	450	4	8.89	0.81
Hillsborough County Sheriff's Office	Hillsborough	FL	1223	10	8.18	0.81
Colorado Springs Police Department	El Paso	CO	668	5	7.49	0.80
Richland County Sheriff's Office	Richland	SC	512	3	5.86	0.78
Marion County Sheriff's Office	Marion	IN	740	7	9.46	0.77
Columbus Police Department	Franklin	OH	1886	9	4.77	0.77
Fresno Police Department	Fresno	CA	828	7	8.45	0.75
Prince William County Police Department	Prince William	VA	546	3	5.49	0.75
Milwaukee County Sheriff's Office	Milwaukee	WI	524	7	13.36	0.74
Kansas City Police Department	Jackson	MO	1421	5	3.52	0.74
Cobb County Police Department	Cobb	GA	590	5	8.47	0.73
Orlando Police Department	Orange	FL	757	8	10.57	0.70
Tulare County Sheriff's Office	Tulare	CA	513	3	5.85	0.68
St. Petersburg Police Department	Pinellas	FL	510	6	11.76	0.65
Fairfax County Police Department	Fairfax	VA	1419	7	4.93	0.65
Syracuse Police Department	Onondaga	NY	489	3	6.13	0.64
Loudoun County Sheriff's Office	Loudoun	VA	448	2	4.46	0.64
New Mexico State Police	Santa Fe	NM	528	13	24.62	0.63
Worcester Police Department	Worcester	MA	482	5	10.37	0.63
Tucson Police Department	Pima	AZ	1032	6	5.81	0.61
Paterson Police	Passaic	NJ	497	3	6.04	0.60
Miami Police Department	Miami-Dade	FL	1104	14	12.68	0.56

Anne Arundel County Police Department	Anne Arundel	MD	633	3	4.74	0.56
San Bernardino County Sheriff's Office	San Bernardino	CA	1797	11	6.12	0.54
Little Rock Police Department	Pulaski	AR	520	2	3.85	0.52
Calcasieu Parish Sheriff's Office	Calcasieu	LA	592	1	1.69	0.52
San Jose Police Department	Santa Clara	CA	1382	9	6.51	0.51
Gwinnett County Police Department	Gwinnett	GA	682	4	5.87	0.50
Riverside County Sheriff's Office	Riverside	CA	2147	11	5.12	0.50
Baltimore County Police Department	Baltimore	MD	1910	4	2.09	0.50
Orange County Sheriff-Coroner Department	Orange	CA	1794	14	7.80	0.47
Seattle Police Department	King	WA	1283	9	7.01	0.47
Phoenix Police Department	Maricopa	AZ	3388	17	5.02	0.45
Nassau County Police Department	Nassau	NY	2732	6	2.20	0.45
Buffalo Police Department	Erie	NY	793	4	5.04	0.44
Fulton County Sheriff's Office	Fulton	GA	516	4	7.75	0.43
Sacramento County Sheriff's Office	Sacramento	CA	1409	6	4.26	0.42
Dane County Sheriff's Office	Dane	WI	454	2	4.41	0.41
Las Vegas Metro Police Department	Clark	NV	2942	8	2.72	0.41
Rochester Police Department	Monroe	NY	703	3	4.27	0.40
Wichita Police Department	Sedgwick	KS	662	2	3.02	0.40
Suffolk County Police Department	Suffolk	NY	2622	6	2.29	0.40
San Diego Police Department	San Diego	CA	1951	12	6.15	0.39
Gwinnett County Sheriff's Office	Gwinnett	GA	531	3	5.65	0.37
Brevard County Sheriff's Office	Brevard	FL	497	2	4.02	0.37
Sacramento Police Department	Sacramento	CA	701	5	7.13	0.35
Fort Lauderdale Police Department	Broward	FL	482	6	12.45	0.34
Delaware State Police	Kent	DE	658	3	4.56	0.33
Washington Metro Area Transit Auth. Police	DC	DC	442	2	4.52	0.33
Chesterfield County Police Department	Chesterfield	VA	475	1	2.11	0.32
Los Angeles Police Department	Los Angeles	CA	9727	30	3.08	0.31
Bexar County Sheriff's Office	Bexar	TX	526	5	9.51	0.29
Fairfax County Sheriff's Office	Fairfax	VA	499	3	6.01	0.28
King County Sheriff's Office	King	WA	721	5	6.93	0.26
Tampa Police Department	Hillsborough	FL	980	3	3.06	0.24
San Diego County Sheriff's Office	San Diego	CA	1322	7	5.30	0.23
Knox County Sheriff's Office	Knox	TN	456	1	2.19	0.23
South Carolina Highway Patrol	Richland	SC	967	10	10.34	0.22

Yonkers Police Department	Westchester	NY	641	2	3.12	0.21
Mississippi Highway Safety Patrol	Hinds	MS	594	6	10.10	0.20
Pennsylvania State Police	Dauphin	PA	4458	26	5.83	0.20
Oakland Police Department	Alameda	CA	773	3	3.88	0.20
St. Louis County Police Dept	St. Louis	MO	781	2	2.56	0.20
Madison Police Department	Dane	WI	437	1	2.29	0.20
Arlington Police Department	Tarrant	TX	610	3	4.92	0.17
Franklin County Sheriff's Office	Franklin	OH	455	2	4.40	0.17
District of Columbia Protective Services Police	DC	DC	484	1	2.07	0.17
Maryland State Police	Baltimore	MD	1440	9	6.25	0.16
El Paso County Sheriff's Office	El Paso	CO	454	1	2.20	0.16
Monmouth County Sheriff's Office	Monmouth	NJ	494	1	2.02	0.16
Massachusetts State Police	Middlesex	MA	2310	10	4.33	0.15
New Jersey State Police	Mercer	NJ	3053	13	4.26	0.15
Will County Sheriff's Office	Will	IL	445	1	2.25	0.15
Cook County Sheriff's Office	Cook	IL	5655	8	1.41	0.15
Los Angeles County Sheriff's Office	Los Angeles	CA	9461	14	1.48	0.14
Oklahoma Department of Public Safety	Oklahoma	OK	825	5	6.06	0.13
Alameda County Sheriff's Office	Alameda	CA	928	2	2.16	0.13
Ventura County Sheriff's Office	Ventura	CA	755	1	1.32	0.12
Connecticut State Police	Middlesex	CT	1227	4	3.26	0.11
Fresno County Sheriff's Office	Fresno	CA	461	1	2.17	0.11
North Las Vegas Police Department	Clark	NV	471	2	4.25	0.10
Pima County Sheriff's Dept.	Pima	AZ	554	1	1.81	0.10
Contra Costa County Sheriff's Office	Contra Costa	CA	679	1	1.47	0.10
Michigan State Police	Ingham	MI	1732	9	5.20	0.09
Minnesota State Patrol	Ramsey	MN	530	4	7.55	0.08
Colorado State Patrol	Jefferson	CO	742	4	5.39	0.08
Illinois State Police	Sangamon	IL	2105	10	4.75	0.08
North Carolina State Highway Patrol	Wake	NC	1827	8	4.38	0.08
Florida Highway Patrol	Leon	FL	1606	14	8.72	0.07
Utah Department of Public Safety	Salt Lake	UT	475	2	4.21	0.07
Arkansas State Police	Pulaski	AR	525	2	3.81	0.07
Kentucky State Police	Franklin	KY	882	3	3.40	0.07
Iowa Department of Public Safety	Polk	IA	669	2	2.99	0.07
School District of Philadelphia Police	Philadelphia	PA	450	1	2.22	0.07

Harris County Sheriff's Office	Harris	TX	2558	3	1.17	0.07
Tennessee Department of Safety	Davidson	TN	942	4	4.25	0.06
Indiana State Police	Marion	IN	1315	4	3.04	0.06
Santa Clara County Sheriff's Office	Santa Clara	CA	450	1	2.22	0.06
Maricopa County Sheriff's Office	Maricopa	AZ	766	2	2.61	0.05
Arizona Department of Public Safety	Maricopa	AZ	1244	3	2.41	0.05
Mesa Police Department	Maricopa	AZ	831	2	2.41	0.05
Nebraska State Patrol	Lancaster	NE	491	1	2.04	0.05
Wayne County Sheriff's Office	Wayne	MI	1062	1	0.94	0.05
Long Beach Police Department	Los Angeles	CA	968	4	4.13	0.04
Alabama Department of Public Safety	Montgomery	AL	763	2	2.62	0.04
Dallas County Sheriff's Office	Dallas	TX	449	1	2.23	0.04
Louisiana State Police	E. Baton Rouge	LA	1215	2	1.65	0.04
Virginia State Police	Chesterfield	VA	1873	3	1.60	0.04
Ohio State Highway Patrol	Franklin	OH	1560	4	2.56	0.03
California Highway Patrol	Sacramento	CA	7202	13	1.81	0.03
Washington State Patrol	Thurston	WA	1132	2	1.77	0.03
New York State Police	Albany	NY	4847	5	1.03	0.03
Florida Fish & Wildlife Conservation Commission	Leon	FL	626	4	6.39	0.02
New York State Metro Transportation Auth. Police	New York	NY	694	2	2.88	0.02
Maryland Transportation Authority Police	Baltimore	MD	456	1	2.19	0.02
Texas Department of Public Safety	Travis	TX	3529	6	1.70	0.02
Georgia Department of Public Safety	Fulton	GA	1048	1	0.95	0.01
Port Authority of New York & New Jersey Police	Hudson	NJ	1667	1	0.60	0.01
New York State Courts Officers	New York	NY	4500	1	0.22	0.01

Appendix C-2. Nonmetropolitan State & Local Law Enforcement Agencies in Study: Rates of Officers Arrested, 2005-2011 (Sorted by Rate per 100,000 Population)

Agency	County	State	# of Full-Time Sworn Personnel	Per Agency	Per 1,000 Officers	Per 100,000 Population
Petroleum County Sheriff's Office	Petroleum	MT	1	1	1000.00	202.43
Terrell County Sheriff's Office	Terrell	TX	5	1	200.00	101.63
Talbot County Sheriff's Office	Talbot	GA	8	3	375.00	43.70
La Salle County Sheriff's Office	La Salle	TX	10	3	300.00	43.57
Elgin Police Department	Grant	ND	1	1	1000.00	41.77
Griggs County Sheriff's Office	Griggs	ND	3	1	333.33	41.32
Crystal City Police Department	Zavala	TX	11	4	363.64	34.26
Mounds Police Dept	Pulaski	IL	1	2	2000.00	32.46
Pulaski County Sheriff's Office	Pulaski	IL	11	2	181.82	32.46
Carter County Sheriff's Office	Carter	MO	3	2	666.67	31.92
Franklin Police Dept	Franklin	NE	2	1	500.00	31.01
Lake County Sheriff's Office	Lake	CO	9	2	222.22	27.36
Henry County Sheriff's Office	Henry	VA	112	14	125.00	25.85
Jackson County Sheriff's Office	Jackson	TN	14	3	214.29	25.78
Lamoure Police Department	LaMoure	ND	1	1	1000.00	24.16
Cochran Police Department	Bleckley	GA	14	3	214.29	22.97
Grant County Sheriff's Office	Grant	OK	5	1	200.00	22.09
Guadalupe County Sheriff's Office	Guadalupe	NM	3	1	333.33	21.34
Mora County Sheriff's Office	Mora	NM	5	1	200.00	20.49
Edenton Police Department	Chowan	NC	12	3	250.00	20.28
Allendale Police Department	Allendale	SC	10	2	200.00	19.20
Oregon County Sheriff's Office	Oregon	MO	5	2	400.00	18.38
Helena\West Helena Police Department	Phillips	AR	30	4	133.33	18.38
Emery County Sheriff's Office	Emery	UT	26	2	76.92	18.22
Gallatin County Sheriff's Office	Gallatin	IL	3	1	333.33	17.89
Cherokee Police Department	Alfalfa	OK	2	1	500.00	17.72
Norton Police Department	Norton	KS	6	1	166.67	17.63
Seneca County Sheriff's Office	Seneca	NY	23	6	260.87	17.02
Haskell Police Department	Haskell	TX	3	1	333.33	16.95
Montpelier Police Department	Bear Lake	ID	5	1	200.00	16.71
Creston Police Department	Union	IA	10	2	200.00	15.96

Wilson Police Department	Ellsworth	KS	1	1	1000.00	15.39
Butler County Sheriff's Office	Butler	AL	9	3	333.33	14.32
Powell County Sheriff's Office	Powell	MT	10	1	100.00	14.23
Kermit Police Department	Winkler	TX	10	1	100.00	14.06
Winkler County Sheriff's Office	Winkler	TX	10	1	100.00	14.06
Nicholas County Sheriff's Office	Nicholas	KY	1	1	1000.00	14.02
Carlisle Police Department	Nicholas	KY	5	1	200.00	14.02
Woodruff County Sheriff's Office	Woodruff	AR	6	1	166.67	13.77
Montezuma Police Department	Macon	GA	11	2	181.82	13.57
Hamburg Police Department	Fremont	IA	1	1	1000.00	13.44
Fremont County Sheriff's Office	Fremont	IA	7	1	142.86	13.44
Ferry County Sheriff's Office	Ferry	WA	10	1	100.00	13.24
Nebraska City Police Dept	Otoe	NE	15	2	133.33	12.71
Tipton Police Department	Tillman	OK	1	1	1000.00	12.51
Chilhowie Police Department	Smyth	VA	6	4	666.67	12.42
Natchez Police Dept.	Adams	MS	48	4	83.33	12.39
Pearson Police Department	Atkinson	GA	5	1	200.00	11.94
Aspen Police Department	Pitkin	CO	23	2	86.96	11.66
Pocahontas County Sheriff's Office	Pocahontas	WV	5	1	200.00	11.47
Glendive Police Department	Dawson	MT	9	1	111.11	11.15
Greene County Sheriff's Office	Greene	AL	11	1	90.91	11.06
Tucumcari Police Department	Quay	NM	13	1	76.92	11.06
Mason County Sheriff's Office	Mason	WV	21	3	142.86	10.98
Caruthersville Police Department	Pemiscot	MO	21	2	95.24	10.93
Belle Police Department	Maries	MO	3	1	333.33	10.90
Moab Police Department	Grand	UT	15	1	66.67	10.84
Pineview Police Department	Wilcox	GA	1	1	1000.00	10.80
Rochelle Police Department	Wilcox	GA	4	1	250.00	10.80
Osceola Police Department	Clarke	IA	9	1	111.11	10.77
Rosebud Sioux Tribal Police	Todd	SD	27	1	37.04	10.40
Fayette County Sheriff's Office	Fayette	OH	22	3	136.36	10.33
McIntosh County Sheriff's Office	McIntosh	OK	17	2	117.65	9.88
Lewis County Sheriff's Office	Lewis	MO	5	1	200.00	9.79
Fairfax Police Department	Allendale	SC	6	1	166.67	9.60
Roosevelt County Sheriff's Office	Roosevelt	MT	11	1	90.91	9.59
Holt County Sheriff's Office	Holt	NE	5	1	200.00	9.58

Towns County Sheriff's Office	Towns	GA	18	1	55.56	9.55
Keokuk County Sheriff's Office	Keokuk	IA	4	1	250.00	9.51
Tuskegee Police Department	Macon	AL	23	2	86.96	9.32
Pineland Police Department	Sabine	TX	2	1	500.00	9.23
Forest City Police Department	Winnebago	IA	9	1	111.11	9.20
Middlesex County Sheriff's Office	Middlesex	VA	17	1	58.82	9.12
Alma Police Department	Bacon	GA	10	1	100.00	9.01
Morrow County Sheriff's Office	Morrow	OR	14	1	71.43	8.95
Lake County Sheriff's Office	Lake	SD	5	1	200.00	8.93
Hockley County Sheriff's Office	Hockley	TX	11	2	181.82	8.72
Assumption Parish Sheriff's Office	Assumption	LA	50	2	40.00	8.54
Duval County Sheriff's Office	Duval	TX	18	1	55.56	8.49
Madison County Sheriff's Office	Madison	MO	8	1	125.00	8.18
Shelby County Sheriff's Office	Shelby	TX	15	2	133.33	7.86
Bartlesville Police Department	Washington	OK	54	4	74.07	7.85
Blackford County Sheriff's Office	Blackford	IN	8	1	125.00	7.83
Big Horn County Sheriff's Office	Big Horn	MT	8	1	125.00	7.77
McArthur Police Department	Vinton	OH	4	1	250.00	7.44
Ketchikan Police Dept.	Ketchikan Gateway	AK	22	1	45.45	7.42
Providence Police Department	Webster	KY	7	1	142.86	7.34
Beardstown Police Dept	Cass	IL	9	1	111.11	7.33
University of West Alabama Police	Sumter	AL	6	1	166.67	7.27
Craig Police Department	Moffat	CO	22	1	45.45	7.25
Polk County Police Department	Polk	GA	35	3	85.71	7.23
Lamesa Police Department	Dawson	TX	16	1	62.50	7.23
Roodhouse Police Dept	Greene	IL	4	1	250.00	7.20
Thief River Falls Police Department	Pennington	MN	15	1	66.67	7.18
Bainbridge Police Department	Decatur	GA	40	2	50.00	7.18
Zapata County Sheriff's Office	Zapata	TX	44	1	22.73	7.13
Mineral Wells Police Department	Palo Pinto	TX	30	2	66.67	7.11
Del Norte County Sheriff's Office	Del Norte	CA	30	2	66.67	6.99
Flemingsburg Police Department	Fleming	KY	7	1	142.86	6.97
Danville (City) Sheriff's Office	Danville City	VA	69	3	43.48	6.97
Marlboro County Sheriff's Office	Marlboro	SC	25	2	80.00	6.91
Blountstown Police Dept.	Calhoun	FL	8	1	125.00	6.84
Calhoun County Sheriff's Office	Calhoun	FL	18	1	55.56	6.84

Nye County Sheriff's Office	Nye	NV	108	3	27.78	6.83
Estill County Sheriff's Office	Estill	KY	5	1	200.00	6.82
Marshallville Police Dept.	Macon	GA	4	1	250.00	6.78
Oglethorpe Police Department	Macon	GA	5	1	200.00	6.78
Hennessey Police Department	Kingfisher	OK	3	1	333.33	6.65
Kingfisher County Sheriff's Office	Kingfisher	OK	8	1	125.00	6.65
Vinita Police Department	Craig	OK	15	1	66.67	6.65
Boswell Police Department	Choctaw	OK	2	1	500.00	6.58
Kahoka Police Department	Clark	MO	3	1	333.33	6.58
Hermann Police Department	Gasconade	MO	7	1	142.86	6.57
Winnfield Police Dept	Winn	LA	13	1	76.92	6.53
Winn Parish Sheriff's Office	Winn	LA	23	1	43.48	6.53
Tutwiler Police Department	Tallahatchie	MS	4	1	250.00	6.50
Hastings Police Dept	Adams	NE	36	2	55.56	6.38
Madill Police Department	Marshall	OK	12	1	83.33	6.31
Russellville Police Department	Franklin	AL	25	2	80.00	6.31
New Athens Police Department	Harrison	OH	0	1		6.30
Birchwood Police Department	Washburn	WI	2	1	500.00	6.28
Clay County Sheriff's Office	Clay	AR	7	1	142.86	6.22
Clovis Police Department	Curry	NM	53	3	56.60	6.20
Floyd County Sheriff's Office	Floyd	IA	11	1	90.91	6.13
Winnemucca Police Department	Humboldt	NV	18	1	55.56	6.05
New Martinsville Police Department	Wetzel	WV	10	1	100.00	6.03
Eunice Police Department	St. Landry	LA	32	5	156.25	6.00
Spencer Police Department	Clay	IA	18	1	55.56	6.00
Lancaster Police Department	Garrard	KY	10	1	100.00	5.91
Shelby Police Department	Bolivar	MS	7	2	285.71	5.86
Butte - Silver Bow County Sheriff's Office	Silver Bow	MT	45	2	44.44	5.85
Haynesville Police Dept	Claiborne	LA	7	1	142.86	5.82
Fayette Police Department	Fayette	AL	12	1	83.33	5.80
Simpson County Sheriff's Office	Simpson	KY	11	1	90.91	5.77
Huron Police Department	Beadle	SD	24	1	41.67	5.75
Benzie County Sheriff's Office	Benzie	MI	13	1	76.92	5.71
Muskogee Police Department	Muskogee	OK	90	4	44.44	5.63
Socorro County Sheriff's Office	Socorro	NM	10	1	100.00	5.60
Cross County Sheriff's Office	Cross	AR	17	1	58.82	5.60

Clayton County Sheriff's Office	Clayton	IA	12	1	83.33	5.52
Appling County Sheriff's Office	Appling	GA	14	1	71.43	5.48
Cooter Police Department	Pemiscot	MO	1	1	1000.00	5.47
Olney Police Department	Young	TX	5	1	200.00	5.39
Ranger Police Department	Eastland	TX	5	1	200.00	5.38
Haywood County Sheriff's Office	Haywood	TN	22	1	45.45	5.32
Brownwood Police Department	Brown	TX	38	2	52.63	5.25
Bishopville Police Department	Lee	SC	16	1	62.50	5.20
Lee County Sheriff's Office	Lee	SC	28	1	35.71	5.20
Nashville Police Department	Berrien	GA	15	1	66.67	5.19
Clewiston Police Department	Hendry	FL	20	2	100.00	5.11
Oakwood Police Department	Paulding	OH	1	1	1000.00	5.10
Montague County Sheriff's Office	Montague	TX	10	1	100.00	5.07
Bingen-White Salmon Police Department	Klickitat	WA	6	1	166.67	4.92
Black River Falls Police Department	Jackson	WI	7	1	142.86	4.89
Columbus Police Department	Polk	NC	6	1	166.67	4.88
Ruidoso Police Department	Lincoln	NM	26	1	38.46	4.88
Stover Police Department	Morgan	MO	3	1	333.33	4.86
Delhi Police Department	Richland	LA	5	1	200.00	4.83
Winnsboro Police Department	Franklin	LA	7	1	142.86	4.82
Polk County Sheriff's Office	Polk	GA	27	2	74.07	4.82
Ferriday Police Department	Concordia	LA	10	1	100.00	4.80
Vidalia Police Department	Concordia	LA	20	1	50.00	4.80
St. Landry Parish Sheriff's Office	St. Landry	LA	90	4	44.44	4.80
Columbus Police Department	Colorado	TX	10	1	100.00	4.79
Warren County Sheriff's Office	Warren	NC	30	1	33.33	4.77
Demopolis Police Department	Marengo	AL	19	1	52.63	4.76
Yemassee Police Department	Hampton	SC	7	1	142.86	4.74
Hampton County Sheriff's Office	Hampton	SC	26	1	38.46	4.74
Eatonton Police Department	Putnam	GA	16	1	62.50	4.71
Harrodsburg Police Department	Mercer	KY	16	1	62.50	4.69
Seadrift Police Department	Calhoun	TX	2	1	500.00	4.68
Williams Police Department	Colusa	CA	10	1	100.00	4.67
Tuskegee University Police Department	Macon	AL	33	1	30.30	4.66
Marvell Police Department	Phillips	AR	3	1	333.33	4.60
Union Police Department	Newton	MS	7	1	142.86	4.60

Phillips County Sheriff's Office	Phillips	AR	16	1	62.50	4.60
Eastman Police Department	Dodge	GA	11	1	90.91	4.59
Crossett Police Department	Ashley	AR	15	1	66.67	4.58
Selma Police Department	Dallas	AL	50	2	40.00	4.56
Royston Police Department	Franklin	GA	15	1	66.67	4.53
McDowell County Sheriff's Office	McDowell	WV	15	1	66.67	4.52
Gage County Sheriff's Office	Gage	NE	12	1	83.33	4.48
Gold Beach Police Department	Curry	OR	4	1	250.00	4.47
Perry County Sheriff's Office	Perry	IL	12	1	83.33	4.47
Thomas County Sheriff's Office	Thomas	GA	47	2	42.55	4.47
Kauai (County) Police Department	Kauai	HI	125	3	24.00	4.47
Stephens County Sheriff's Office	Stephens	OK	11	2	181.82	4.44
Hempstead County Sheriff's Office	Hempstead	AR	13	1	76.92	4.42
Upper Sandusky Police Department	Wyandot	OH	13	1	76.92	4.42
Franklin County Sheriff's Office	Franklin	IN	12	1	83.33	4.33
Grambling State University Police Dept.	Lincoln	LA	9	2	222.22	4.28
Farmville Police Department	Prince Edward	VA	27	1	37.04	4.28
Pelham Police Department	Mitchell	GA	14	1	71.43	4.26
Osceola County Sheriff's Office	Osceola	MI	18	1	55.56	4.25
Routt County Sheriff's Office	Routt	CO	22	1	45.45	4.25
Nogales Police Department	Santa Cruz	AZ	60	2	33.33	4.22
Navajo Nation Tribal Dept of Law Enforcement	Apache	AZ	393	3	7.63	4.19
Hannahville Tribal Police Department	Menominee	MI	11	1	90.91	4.16
Page County Sheriff's Office	Page	VA	49	1	20.41	4.16
Stark County Sheriff's Office	Stark	ND	11	1	90.91	4.13
Monroe County Sheriff's Office	Monroe	FL	189	3	15.87	4.10
Marion Township Police Department	Waushara	WI	1	1	1000.00	4.08
Martin County Sheriff's Office	Martin	NC	34	1	29.41	4.08
Monticello Police	White	IN	12	1	83.33	4.06
Miller County Sheriff's Office	Miller	MO	16	1	62.50	4.04
Humboldt Police Department	Gibson	TN	26	2	76.92	4.03
Saline County Sheriff's Office	Saline	IL	42	1	23.81	4.01
Columbus Police Department	Luna	NM	4	1	250.00	3.98
Luna County Sheriff's Office	Luna	NM	30	1	33.33	3.98
Moberly Police Department	Randolph	MO	32	1	31.25	3.93
Greenville Police Department	Washington	MS	96	2	20.83	3.91

Greensburg Police	Decatur	IN	18	1	55.56	3.89
Oakdale Police Department	Allen	LA	20	1	50.00	3.88
White County Sheriff's Office	White	TN	28	1	35.71	3.87
Sleepy Eye Police Department	Redwood	MN	6	1	166.67	3.86
Selmer Police Department	McNairy	TN	18	1	55.56	3.84
Ridgeville Police	Randolph	IN	2	1	500.00	3.82
Stephens County Sheriff's Office	Stephens	GA	31	1	32.26	3.82
Vernon Parish Sheriff's Office	Vernon	LA	64	2	31.25	3.82
Clarksdale Police Department	Coahoma	MS	35	1	28.57	3.82
San Jacinto County Sheriff's Office	San Jacinto	TX	21	1	47.62	3.79
New Lisbon Police Department	Juneau	WI	4	1	250.00	3.75
Juneau County Sheriff's Office	Juneau	WI	45	1	22.22	3.75
Meridian Police Department	Lauderdale	MS	99	3	30.30	3.74
Helen Police Department	White	GA	10	1	100.00	3.68
White County Sheriff's Office	White	GA	40	1	25.00	3.68
Whiteville Police Department	Hardeman	TN	8	1	125.00	3.67
Grants Police Department	Cibola	NM	14	1	71.43	3.67
Bolivar Police Department	Hardeman	TN	21	1	47.62	3.67
Hardeman County Sheriff's Office	Hardeman	TN	22	1	45.45	3.67
Murphy Police Department	Cherokee	NC	7	1	142.86	3.64
Custer County Sheriff's Office	Custer	OK	12	1	83.33	3.64
Pauls Valley Police Department	Garvin	OK	13	1	76.92	3.63
Zolfo Springs Police Department	Hardee	FL	1	1	1000.00	3.61
Gaffney Police Department	Cherokee	SC	37	2	54.05	3.61
Cherokee County Sheriff's Office	Cherokee	SC	48	2	41.67	3.61
Great Bend Police Department	Barton	KS	30	1	33.33	3.61
Scotts Hill Police Department	Henderson	TN	3	1	333.33	3.60
Dillon Police Department	Summit	CO	9	1	111.11	3.57
Frisco Police Department	Summit	CO	13	1	76.92	3.57
Perryville Police Department	Boyle	KY	1	1	1000.00	3.52
Zanesville Police Department	Muskingum	OH	53	3	56.60	3.49
Bennettsville Police Department	Marlboro	SC	36	1	27.78	3.46
Tabor City Police Department	Columbus	NC	9	2	222.22	3.44
Washington Court House Police Dept.	Fayette	OH	22	1	45.45	3.44
Inman Police Department	McPherson	KS	2	1	500.00	3.43
Ripley Police Department	Jackson	WV	9	1	111.11	3.42

Las Vegas Police Department	San Miguel	NM	27	1	37.04	3.40
Santa Clara Police Department	Grant	NM	5	1	200.00	3.39
Philadelphia Police Department	Neshoba	MS	27	1	37.04	3.37
Lenoir County Sheriff's Office	Lenoir	NC	58	2	34.48	3.36
Bowman Police Department	Orangeburg	SC	3	3	1000.00	3.24
Orangeburg Public Safety	Orangeburg	SC	72	3	41.67	3.24
Princeton Police Department	Mercer	WV	17	2	117.65	3.21
Albert Lea Police Department	Freeborn	MN	29	1	34.48	3.20
Juneau Police Dept.	Juneau	AK	44	1	22.73	3.20
Ontario Police Department	Malheur	OR	22	1	45.45	3.19
Jennings Police Department	Jefferson Davis	LA	24	1	41.67	3.17
Daviess County Sheriff's Office	Daviess	IN	19	1	52.63	3.16
Roseboro Police Department	Sampson	NC	5	2	400.00	3.15
Fairland Police Department	Ottawa	OK	4	1	250.00	3.14
Commerce Police Department	Ottawa	OK	5	1	200.00	3.14
Kenton Police Department	Obion	TN	5	1	200.00	3.14
Beeville Police Department	Bee	TX	23	1	43.48	3.14
Miami Police Department	Ottawa	OK	30	1	33.33	3.14
Union City Police Department	Obion	TN	36	1	27.78	3.14
Dillon Police Department	Dillon	SC	25	1	40.00	3.12
Kingsville Police Department	Kleberg	TX	45	1	22.22	3.12
Marion Police Department	Smyth	VA	18	1	55.56	3.10
Mount Pleasant Police Department	Titus	TX	29	1	34.48	3.09
Lake County Sheriff's Office	Lake	CA	61	2	32.79	3.09
Vernal Police Department	Uintah	UT	22	1	45.45	3.07
Emmet County Sheriff's Office	Emmet	MI	23	1	43.48	3.06
Roswell Police Department	Chaves	NM	80	2	25.00	3.05
Errol Police Department	Coos	NH	0	1		3.03
Onley Police Department	Accomack	VA	4	1	250.00	3.02
Denton Police Department	Caroline	MD	13	1	76.92	3.02
Marion Police Department	Marion	SC	24	1	41.67	3.02
Accomack County Sheriff's Office	Accomack	VA	27	1	37.04	3.02
Virginia Marine Resources Commission	Newport News City	VA	60	1	16.67	3.02
Randolph County Sheriff's Office	Randolph	IL	13	1	76.92	2.99
Kitty Hawk Police Department	Dare	NC	17	1	58.82	2.95
Dodge City Police Department	Ford	KS	49	1	20.41	2.95

Turkey Creek Police Department	Evangeline	LA	1	1	1000.00	2.94
Rosedale Police Department	Bolivar	MS	5	1	200.00	2.93
Bolivar County Sheriff's Office	Bolivar	MS	18	1	55.56	2.93
Hemingway Police Department	Williamsburg	SC	4	1	250.00	2.91
Shinnston Police Department	Harrison	WV	7	2	285.71	2.89
Big Spring Police Department	Howard	TX	40	1	25.00	2.86
Greenbrier County Sheriff's Office	Greenbrier	WV	30	1	33.33	2.82
Whitley County Sheriff's Office	Whitley	KY	12	1	83.33	2.81
Williamsburg Police Department	Whitley	KY	12	1	83.33	2.81
Corbin Police Department	Whitley	KY	19	1	52.63	2.81
Lebanon Police Department	Laclede	MO	30	1	33.33	2.81
Deridder Police Department	Beauregard	LA	24	1	41.67	2.80
Fort Madison Police Department	Lee	IA	17	1	58.82	2.79
Minocqua Police Department	Oneida	WI	9	1	111.11	2.78
Putnam County Sheriff's Office	Putnam	TN	58	2	34.48	2.77
Cookeville Police Department	Putnam	TN	70	2	28.57	2.77
Halifax County Sheriff's Office	Halifax	VA	29	1	34.48	2.76
Plainview Police Department	Hale	TX	34	1	29.41	2.76
Vergennes Police Department	Addison	VT	5	1	200.00	2.72
Shenandoah Borough Police Department	Schuylkill	PA	7	4	571.43	2.70
Seaside Police Department	Clatsop	OR	18	1	55.56	2.70
Canton Police Dept	Fulton	IL	23	1	43.48	2.70
Scottsbluff Police Dept	Scotts Bluff	NE	30	1	33.33	2.70
Corinth Police Department	Alcorn	MS	39	1	25.64	2.70
Graham County Sheriff's Office	Graham	AZ	23	1	43.48	2.69
Murray Police Department	Calloway	KY	31	1	32.26	2.69
Ada Police Department	Pontotoc	OK	42	1	23.81	2.67
BYU-Idaho Police Department	Madison	ID	10	1	100.00	2.66
Lockhart Police Department	Covington	AL	1	1	1000.00	2.65
Floralia Police Department	Covington	AL	6	1	166.67	2.65
Andalusia Police Dept.	Covington	AL	30	1	33.33	2.65
Fort Dodge Police Department	Webster	IA	37	1	27.03	2.63
East Brewton Police Department	Escambia	AL	6	1	166.67	2.61
Sault Ste. Marie Police Department	Chippewa	MI	25	1	40.00	2.60
Sandusky Police Department	Erie	OH	54	2	37.04	2.59
Waynesburg Borough Police Department	Greene	PA	8	1	125.00	2.58

Ridgeville Police Department	Dorchester	SC	2	1	500.00	2.57
St. George Police Department	Dorchester	SC	10	1	100.00	2.57
Chaffee Police Department	Scott	MO	5	1	200.00	2.55
Austin Police Department	Mower	MN	31	1	32.26	2.55
Hendry County Sheriff's Office	Hendry	FL	67	1	14.93	2.55
Natchitoches Parish Sheriff's Office	Natchitoches	LA	45	1	22.22	2.53
Ravalli County Sheriff's Office	Ravalli	MT	29	1	34.48	2.49
Rio Arriba County Sheriff's Office	Rio Arriba	NM	22	1	45.45	2.48
Manitowoc Police Department	Manitowoc	WI	64	2	31.25	2.46
Wilson Police Department	Wilson	NC	114	2	17.54	2.46
Jim Wells County Sheriff's Office	Jim Wells	TX	27	1	37.04	2.45
Alice Police Department	Jim Wells	TX	37	1	27.03	2.45
Okanogan County Sheriff's Office	Okanogan	WA	30	1	33.33	2.43
Elmore Police Department	Ottawa	OH	4	1	250.00	2.41
Marble Head Police Department	Ottawa	OH	4	1	250.00	2.41
St. Paul Police Department	Wise	VA	6	1	166.67	2.41
Coeburn Police Department	Wise	VA	7	1	142.86	2.41
Rockmart Police Department	Polk	GA	18	1	55.56	2.41
Baxter County Sheriff's Office	Baxter	AR	32	1	31.25	2.41
Bunkie Police Department	Avoyelles	LA	12	1	83.33	2.38
Greene County Sheriff's Office	Greene	AR	15	1	66.67	2.38
Marksville Police Department	Avoyelles	LA	20	1	50.00	2.38
Atwater Police Department	Kandiyohi	MN	1	1	1000.00	2.37
Sedalia Police Dept	Pettis	MO	44	1	22.73	2.37
Caddo Police Department	Bryan	OK	3	1	333.33	2.36
Millersburg Police Department	Holmes	OH	10	1	100.00	2.36
Holmes County Sheriff's Office	Holmes	OH	33	1	30.30	2.36
Durant Police Department	Bryan	OK	36	1	27.78	2.36
Seymour Police	Jackson	IN	39	1	25.64	2.36
Marble Falls Police Department	Burnet	TX	27	1	37.04	2.34
Muscatine Police Department	Muscatine	IA	39	1	25.64	2.34
Poplar Bluff Police Department	Butler	MO	43	1	23.26	2.34
Foster Township Police Department	McKean	PA	4	1	250.00	2.30
Grand Traverse County Sheriff's Office	Grand Traverse	MI	64	2	31.25	2.30
Newport Police Department	Sullivan	NH	14	1	71.43	2.29
Wheeler Police Department	Dunn	WI	0	1		2.28

Mason City Police Department	Cerro Gordo	IA	46	1	21.74	2.26
Sweetwater Police Department	Monroe	TN	18	1	55.56	2.25
Meigs Police Department	Thomas	GA	3	1	333.33	2.24
Monroe County Sheriff's Office	Monroe	WI	23	1	43.48	2.24
Robeson County Sheriff's Office	Robeson	NC	128	3	23.44	2.24
Marlow Police Department	Stephens	OK	10	1	100.00	2.22
Black Mountain Police Department	Buncombe	NC	18	1	55.56	2.22
McDowell County Sheriff's Office	McDowell	NC	40	1	25.00	2.22
Missouri University of Science & Tech Police Dept	Phelps	MO	11	1	90.91	2.21
St. Marys Police Department	Auglaize	OH	15	1	66.67	2.18
Ravenna Police Dept	Buffalo	NE	3	1	333.33	2.17
Lawrence County Sheriff's Office	Lawrence	IN	25	1	40.00	2.17
Gillette Police Department	Campbell	WY	45	1	22.22	2.17
Campbell County Sheriff's Office	Campbell	WY	58	1	17.24	2.17
Lincoln County Sheriff's Office	Lincoln	OR	65	1	15.38	2.17
Santee Police Department	Orangeburg	SC	6	2	333.33	2.16
Kaw Nation Tribal Police	Kay	OK	6	1	166.67	2.15
Chesterfield County Sheriff's Office	Chesterfield	SC	41	1	24.39	2.14
Lincoln Parish Sheriff's Office	Lincoln	LA	46	1	21.74	2.14
Tahlequah Police Department	Cherokee	OK	32	1	31.25	2.13
Douglas County Sheriff's Office	Douglas	NV	100	1	10.00	2.13
Bogalusa Police Department	Washington	LA	37	1	27.03	2.12
Kendallville Police	Noble	IN	18	1	55.56	2.10
Freedom Police Department	Carroll	NH	3	1	333.33	2.09
Wolfeboro Police Department	Carroll	NH	12	1	83.33	2.09
Washington Police Department	Beaufort	NC	36	1	27.78	2.09
Delhi Village Police Department	Delaware	NY	4	1	250.00	2.08
White Cloud Police Department	Newaygo	MI	2	1	500.00	2.06
Newaygo County Sheriff's Office	Newaygo	MI	25	1	40.00	2.06
Elko County Sheriff's Office	Elko	NV	57	1	17.54	2.05
Del Rio Police Department	Val Verde	TX	65	1	15.38	2.05
Dewitt Police Department	Clinton	IA	10	1	100.00	2.04
Kings Mountain Police Department	Cleveland	NC	30	2	66.67	2.04
Hunter Police Department	Greene	NY	2	1	500.00	2.03
Cortland Police Department	Cortland	NY	44	1	22.73	2.03
Frankfort Police Department	Franklin	KY	65	1	15.38	2.03

Middletown Police	Henry	IN	5	1	200.00	2.02
Shelby County Sheriff's Office	Shelby	OH	30	1	33.33	2.02
New Castle Police	Henry	IN	35	1	28.57	2.02
Kerrville Police Department	Kerr	TX	51	1	19.61	2.02
Port Jefferson Police Department	Shelby	OH	0	1		2.02
Medina Police Department	Gibson	TN	11	1	90.91	2.01
Paris Police Department	Lamar	TX	54	1	18.52	2.01
Jackson County Sheriff's Office	Jackson	FL	61	1	16.39	2.01
Level Plains Police Department	Dale	AL	5	1	200.00	1.99
Dale County Sheriff's Office	Dale	AL	0	1		1.99
Norwich Police Department	Chenango	NY	19	1	52.63	1.98
Kingsland Police Dept	Camden	GA	43	1	23.26	1.98
Leland Police Department	Washington	MS	18	1	55.56	1.96
Appalachian State University Police Dept	Watauga	NC	25	1	40.00	1.96
Boone Police Department	Watauga	NC	38	1	26.32	1.96
Platteville Police Department	Grant	WI	20	1	50.00	1.95
Durango Police Department	La Plata	CO	50	1	20.00	1.95
Vail Police Department	Eagle	CO	28	1	35.71	1.92
Dixon Police Department	Pulaski	MO	5	1	200.00	1.91
Richland Police Dept	Pulaski	MO	5	1	200.00	1.91
Leesville Police Department	Vernon	LA	28	1	35.71	1.91
Galesburg Police Dept	Knox	IL	53	1	18.87	1.89
Bridgeport Police Department	Jackson	AL	6	1	166.67	1.88
Scottsboro Police Department	Jackson	AL	44	1	22.73	1.88
Byron Police Dept	Ogle	IL	7	1	142.86	1.87
Columbiana County Sheriff's Office	Columbiana	OH	22	2	90.91	1.85
Sugarcreek Borough Police Department	Venango	PA	5	1	200.00	1.82
Calhoun Police Department	Gordon	GA	44	1	22.73	1.81
Saline County Sheriff's Office	Saline	KS	44	1	22.73	1.80
Tuscola County Sheriff's Office	Tuscola	MI	25	1	40.00	1.79
New Castle Police Department	Garfield	CO	7	1	142.86	1.77
Marion County Sheriff's Office	Marion	WV	27	1	37.04	1.77
Springfield Police Department	Windsor	VT	15	1	66.67	1.76
Bloomville Police Department	Seneca	OH	0	1		1.76
Fryeburg Police Department	Oxford	ME	5	1	200.00	1.73
Lee County Sheriff's Office	Lee	NC	47	1	21.28	1.73

Sanford Police Department	Lee	NC	81	1	12.35	1.73
Fair Bluff Police Department	Columbus	NC	3	1	333.33	1.72
Wallace Police Department	Duplin	NC	12	1	83.33	1.71
Wakeman Police Department	Huron	OH	1	1	1000.00	1.68
Pink Hill Police Department	Lenoir	NC	2	1	500.00	1.68
Monroeville Police Department	Huron	OH	4	1	250.00	1.68
Barre Police Department	Washington	VT	18	1	55.56	1.68
Columbus Police Department	Lowndes	MS	62	1	16.13	1.67
Andrews Police Department	Georgetown	SC	9	1	111.11	1.66
Georgetown County Sheriff's Office	Georgetown	SC	78	1	12.82	1.66
Waukomis Police Department	Garfield	OK	3	1	333.33	1.65
Arcade Police Department	Jackson	GA	9	1	111.11	1.65
Braselton Police Department	Jackson	GA	12	1	83.33	1.65
Commerce Police Department	Jackson	GA	24	1	41.67	1.65
Stanly County Sheriff's Office	Stanly	NC	49	1	20.41	1.65
Clyde Police Department	Sandusky	OH	14	1	71.43	1.64
Starr County Sheriff's Office	Starr	TX	31	1	32.26	1.64
Burr Oak Police Department	St. Joseph	MI	1	1	1000.00	1.63
Sturgis Police Department	St. Joseph	MI	19	1	52.63	1.63
Belpre Police Department	Washington	OH	9	1	111.11	1.62
Rutland Police Department.	Rutland	VT	41	1	24.39	1.62
Bluefield Police Department	Mercer	WV	21	1	47.62	1.61
Sauk County Sheriff's Office	Sauk	WI	118	1	8.47	1.61
Otero County Sheriff's Office	Otero	NM	30	1	33.33	1.57
Alamogordo Department of Public Safety	Otero	NM	71	1	14.08	1.57
Danville Police Department	Pittsylvania	VA	126	1	7.94	1.57
Lakeport Police Department	Lake	CA	12	1	83.33	1.55
Clearlake Police Department	Lake	CA	21	1	47.62	1.55
Eunice Police Department	Lea	NM	8	1	125.00	1.54
Bismarck Police Department	St. Francois	MO	3	1	333.33	1.53
Harrison County Sheriff's Office	Harrison	TX	45	1	22.22	1.52
Klamath Falls Police Department	Klamath	OR	39	1	25.64	1.51
Ishpeming Police Department	Marquette	MI	10	1	100.00	1.49
LaGrange Police Department	Troup	GA	83	1	12.05	1.49
Jamestown Police Department	Chautauqua	NY	62	2	32.26	1.48
Lander University Public Safety	Greenwood	SC	10	1	100.00	1.44

Wilkesboro Police Department	Wilkes	NC	20	1	50.00	1.44
Shawnee Police Department	Pottawatomie	OK	52	1	19.23	1.44
Grant County Sheriff's Office	Grant	IN	45	1	22.22	1.43
Durand Police Department	Shiawassee	MI	5	1	200.00	1.42
Central Michigan University Police Department	Isabella	MI	21	1	47.62	1.42
Haskell Police Department	Muskogee	OK	5	1	200.00	1.41
Fort Gibson Police Department	Muskogee	OK	11	1	90.91	1.41
Rainsville Police Department	DeKalb	AL	11	1	90.91	1.41
DeKalb County Sheriff's Office	DeKalb	AL	34	1	29.41	1.41
Fort Payne Police Department	DeKalb	AL	34	1	29.41	1.41
Muskogee County Sheriff's Office	Muskogee	OK	37	1	27.03	1.41
Forks Police Department	Clallam	WA	9	1	111.11	1.40
McKinley County Sheriff's Office	McKinley	NM	35	1	28.57	1.40
Gallup Police Department	McKinley	NM	62	1	16.13	1.40
Caribou Police Department	Aroostook	ME	14	1	71.43	1.39
Algood Police Department	Putnam	TN	11	1	90.91	1.38
Ocean Shores Police Department	Grays Harbor	WA	14	1	71.43	1.37
Elkin Police Department	Surry	NC	17	1	58.82	1.36
Mount Airy Police Department	Surry	NC	38	1	26.32	1.36
Seneca Police Department	Oconee	SC	34	1	29.41	1.35
Crescent City Police Department	Putnam	FL	5	1	200.00	1.34
Grand Rapids Police Department	Wood	WI	5	1	200.00	1.34
Palatka Police Department	Putnam	FL	37	1	27.03	1.34
Athena Police Department	Umatilla	OR	2	1	500.00	1.32
Berlin Heights Police Department	Erie	OH	1	1	1000.00	1.30
Jaffrey Police Department	Cheshire	NH	10	1	100.00	1.30
Searcy Police Department	White	AR	41	1	24.39	1.30
Berlin Borough Police Department	Somerset	PA	1	1	1000.00	1.29
Meyersdale Borough Police Department	Somerset	PA	2	1	500.00	1.29
Windber Borough Police Department	Somerset	PA	2	1	500.00	1.29
Sullivan County Sheriff's Office	Sullivan	NY	44	1	22.73	1.29
Twin Falls Police Department	Twin Falls	ID	64	1	15.63	1.29
Stillwater Police Department	Payne	OK	74	1	13.51	1.29
New York City Dept of Env. Protection Police	Westchester	NY	168	1	5.95	1.29
Chillicothe Police Department	Ross	OH	47	1	21.28	1.28
Malakoff Police Department	Henderson	TX	4	1	250.00	1.27

Chandler Police Department	Henderson	TX	8	1	125.00	1.27
Olean Police Department	Cattaraugus	NY	32	1	31.25	1.25
Auburn Police Department	Cayuga	NY	70	1	14.29	1.25
Hanceville Police Department	Cullman	AL	9	1	111.11	1.24
Cullman County Sheriff's Office	Cullman	AL	78	1	12.82	1.24
Lawrence Township Police Department	Clearfield	PA	9	1	111.11	1.22
Plattsburgh Police Department	Clinton	NY	47	1	21.28	1.22
Berea Police Department	Madison	KY	30	1	33.33	1.21
Richmond Police Department	Madison	KY	65	1	15.38	1.21
Tupelo Police Department	Lee	MS	115	1	8.70	1.21
Port Barre Police Dept	St. Landry	LA	7	1	142.86	1.20
Opelousas Police Department	St. Landry	LA	58	1	17.24	1.20
Traverse City Police Department	Grand Traverse	MI	32	1	31.25	1.15
Homer City Borough Police Department	Indiana	PA	2	1	500.00	1.13
Robbins Police Department	Moore	NC	5	1	200.00	1.13
Indiana Borough Police Department	Indiana	PA	22	1	45.45	1.13
West Yellowstone Police Department	Gallatin	MT	5	1	200.00	1.12
Woodstock Police Department	Grafton	NH	5	1	200.00	1.12
Quincy Police Department	Grant	WA	12	1	83.33	1.12
Ephrata Police Department	Grant	WA	15	1	66.67	1.12
Lebanon Police Department	Grafton	NH	35	1	28.57	1.12
Gatlinburg Police Department	Sevier	TN	45	1	22.22	1.11
Sevierville Police Department	Sevier	TN	55	1	18.18	1.11
New Castle (city) Police Department	Lawrence	PA	35	1	28.57	1.10
Kalispell Police Department	Flathead	MT	36	1	27.78	1.10
Springfield Police Department	Orangeburg	SC	2	1	500.00	1.08
Sugarcreek Police Department	Tuscarawas	OH	5	1	200.00	1.08
Holly Hill Police Department	Orangeburg	SC	7	1	142.86	1.08
Orangeburg County Sheriff's Office	Orangeburg	SC	92	1	10.87	1.08
Shelby Police Department	Cleveland	NC	70	1	14.29	1.02
Hornell Police Department	Steuben	NY	22	1	45.45	1.01
Steuben County Sheriff's Office	Steuben	NY	26	1	38.46	1.01
Lenawee County Sheriff's Office	Lenawee	MI	44	1	22.73	1.00
North Kingsville Police Department	Ashtabula	OH	5	1	200.00	0.99
Conneaut Police Department	Ashtabula	OH	19	1	52.63	0.99
Geneva Township Police Department	Walworth	WI	6	1	166.67	0.98

Delavan Police Department	Walworth	WI	19	1	52.63	0.98
Allegan County Sheriff's Office	Allegan	MI	59	1	16.95	0.90
Canton Village Police Department	St. Lawrence	NY	8	1	125.00	0.89
Ogdensburg Police Department	St. Lawrence	NY	25	1	40.00	0.89
Earlville Police Dept	La Salle	IL	3	1	333.33	0.88
Oglesby Police Dept	La Salle	IL	8	1	125.00	0.88
La Salle County Sheriff's Office	La Salle	IL	36	1	27.78	0.88
Dunn Police Department	Harnett	NC	37	1	27.03	0.87
Fairmont Police Department	Robeson	NC	13	1	76.92	0.75
Red Springs Police Department	Robeson	NC	16	1	62.50	0.75
Lumberton Police Department	Robeson	NC	73	1	13.70	0.75
Blue Lake Police Department	Humboldt	CA	4	1	250.00	0.74
Eureka Police Department	Humboldt	CA	46	1	21.74	0.74
Newbury Police Department	Merrimack	NH	3	1	333.33	0.68
Allenstown Police Department	Merrimack	NH	10	1	100.00	0.68
Hooksett Police Department	Merrimack	NH	28	1	35.71	0.68
Concord Police Department	Merrimack	NH	77	1	12.99	0.68
Hegins Township Police Department	Schuylkill	PA	2	1	500.00	0.67
Butler Township Police Department	Schuylkill	PA	4	1	250.00	0.67
Mahanoy City Borough Police Department	Schuylkill	PA	4	1	250.00	0.67
Winsted Police Department	Litchfield	CT	4	1	250.00	0.53
New Milford Police Department	Litchfield	CT	46	1	21.74	0.53
Torrington Police Department	Litchfield	CT	79	1	12.66	0.53

Appendix C-3. Primary State Police Agencies in Study: Rates of Officers Arrested, 2005-2011 (Sorted by Rate per 100,000 Population)

Agency	County	State	# of Full-Time Sworn Personnel	Per Agency	Per 1,000 Officers	Per 100,000 Population
New Mexico State Police	Santa Fe	NM	528	13	24.62	0.63
Delaware State Police	Kent	DE	658	3	4.56	0.33
New Hampshire State Police	Merrimack	NH	350	3	8.57	0.23
South Carolina Highway Patrol	Richland	SC	967	10	10.34	0.22
Mississippi Highway Safety Patrol	Hinds	MS	594	6	10.10	0.20
Pennsylvania State Police	Dauphin	PA	4458	26	5.83	0.20
Rhode Island State Police	Providence	RI	201	2	9.95	0.19
Wyoming Highway Patrol	Laramie	WY	204	1	4.90	0.18
Maryland State Police	Baltimore	MD	1440	9	6.25	0.16
Vermont State Police	Washington	VT	307	1	3.26	0.16
Massachusetts State Police	Middlesex	MA	2310	10	4.33	0.15
New Jersey State Police	Mercer	NJ	3053	13	4.26	0.15
Alaska State Troopers	Anchorage	AK	274	1	3.65	0.14
Oklahoma Department of Public Safety	Oklahoma	OK	825	5	6.06	0.13
Nevada Highway Patrol	Carson	NV	417	3	7.19	0.11
Connecticut State Police	Middlesex	CT	1227	4	3.26	0.11
Michigan State Police	Ingham	MI	1732	9	5.20	0.09
Minnesota State Patrol	Ramsey	MN	530	4	7.55	0.08
Colorado State Patrol	Jefferson	CO	742	4	5.39	0.08
Illinois State Police	Sangamon	IL	2105	10	4.75	0.08
North Carolina State Highway Patrol	Wake	NC	1827	8	4.38	0.08
Maine State Police	Kennebec	ME	334	1	2.99	0.08
Arkansas Highway Police	Pulaski	AR	149	2	13.42	0.07
Florida Highway Patrol	Leon	FL	1606	14	8.72	0.07
Utah Department of Public Safety	Salt Lake	UT	475	2	4.21	0.07
Arkansas State Police	Pulaski	AR	525	2	3.81	0.07
Kentucky State Police	Franklin	KY	882	3	3.40	0.07
Iowa Department of Public Safety	Polk	IA	669	2	2.99	0.07
Tennessee Department of Safety	Davidson	TN	942	4	4.25	0.06
Idaho State Police	Ada	ID	264	1	3.79	0.06
Indiana State Police	Marion	IN	1315	4	3.04	0.06
Arizona Department of Public Safety	Maricopa	AZ	1244	3	2.41	0.05

Nebraska State Patrol	Lancaster	NE	491	1	2.04	0.05
Alabama Department of Public Safety	Montgomery	AL	763	2	2.62	0.04
Louisiana State Police	East Baton Rouge	LA	1215	2	1.65	0.04
Virginia State Police	Chesterfield	VA	1873	3	1.60	0.04
Ohio State Highway Patrol	Franklin	OH	1560	4	2.56	0.03
California Highway Patrol	Sacramento	CA	7202	13	1.81	0.03
Washington State Patrol	Thurston	WA	1132	2	1.77	0.03
New York State Police	Albany	NY	4847	5	1.03	0.03
Texas Department of Public Safety	Travis	TX	3529	6	1.70	0.02
Georgia Department of Public Safety	Fulton	GA	1048	1	0.95	0.01

Appendix C-4. Sheriff's Offices in Study: Rates of Officers Arrested, 2005-2011 (Sorted by Rate per 100,000 Population)

Agency	County	State	# of Full-Time Sworn Personnel	Per Agency	Per 1,000 Officers	Per 100,000 Population
Petroleum County Sheriff's Office	Petroleum	MT	1	1	1000.00	202.43
Terrell County Sheriff's Office	Terrell	TX	5	1	200.00	101.63
Talbot County Sheriff's Office	Talbot	GA	8	3	375.00	43.70
La Salle County Sheriff's Office	La Salle	TX	10	3	300.00	43.57
Griggs County Sheriff's Office	Griggs	ND	3	1	333.33	41.32
Pulaski County Sheriff's Office	Pulaski	IL	11	2	181.82	32.46
Carter County Sheriff's Office	Carter	MO	3	2	666.67	31.92
Baker County Sheriff's Office	Baker	GA	3	1	333.33	28.98
Lake County Sheriff's Office	Lake	CO	9	2	222.22	27.36
Henry County Sheriff's Office	Henry	VA	112	14	125.00	25.85
Jackson County Sheriff's Office	Jackson	TN	14	3	214.29	25.78
Grant County Sheriff's Office	Grant	OK	5	1	200.00	22.09
Guadalupe County Sheriff's Office	Guadalupe	NM	3	1	333.33	21.34
Mora County Sheriff's Office	Mora	NM	5	1	200.00	20.49
Oregon County Sheriff's Office	Oregon	MO	5	2	400.00	18.38
Emery County Sheriff's Office	Emery	UT	26	2	76.92	18.22
Gallatin County Sheriff's Office	Gallatin	IL	3	1	333.33	17.89
Seneca County Sheriff's Office	Seneca	NY	23	6	260.87	17.02
Butler County Sheriff's Office	Butler	AL	9	3	333.33	14.32
Powell County Sheriff's Office	Powell	MT	10	1	100.00	14.23
Winkler County Sheriff's Office	Winkler	TX	10	1	100.00	14.06
Nicholas County Sheriff's Office	Nicholas	KY	1	1	1000.00	14.02
Woodruff County Sheriff's Office	Woodruff	AR	6	1	166.67	13.77
Fremont County Sheriff's Office	Fremont	IA	7	1	142.86	13.44
Union County Sheriff's Office	Union	IN	6	1	166.67	13.30
Ferry County Sheriff's Office	Ferry	WA	10	1	100.00	13.24
Lincoln County Sheriff's Office	Lincoln	GA	12	1	83.33	12.51
Bracken County Sheriff's Office	Bracken	KY	4	1	250.00	11.78
Pocahontas County Sheriff's Office	Pocahontas	WV	5	1	200.00	11.47
Greene County Sheriff's Office	Greene	AL	11	1	90.91	11.06
Mason County Sheriff's Office	Mason	WV	21	3	142.86	10.98
Caroline County Sheriff's Office	Caroline	VA	49	3	61.22	10.51

Fayette County Sheriff's Office	Fayette	OH	22	3	136.36	10.33
McIntosh County Sheriff's Office	McIntosh	OK	17	2	117.65	9.88
Lewis County Sheriff's Office	Lewis	MO	5	1	200.00	9.79
Roosevelt County Sheriff's Office	Roosevelt	MT	11	1	90.91	9.59
Holt County Sheriff's Office	Holt	NE	5	1	200.00	9.58
Towns County Sheriff's Office	Towns	GA	18	1	55.56	9.55
Keokuk County Sheriff's Office	Keokuk	IA	4	1	250.00	9.51
Middlesex County Sheriff's Office	Middlesex	VA	17	1	58.82	9.12
Morrow County Sheriff's Office	Morrow	OR	14	1	71.43	8.95
Lake County Sheriff's Office	Lake	SD	5	1	200.00	8.93
St. Helena Parish Sheriff's Office	St. Helena	LA	22	1	45.45	8.93
Lowndes County Sheriff's Office	Lowndes	AL	14	1	71.43	8.85
Hockley County Sheriff's Office	Hockley	TX	11	2	181.82	8.72
Assumption Parish Sheriff's Office	Assumption	LA	50	2	40.00	8.54
Duval County Sheriff's Office	Duval	TX	18	1	55.56	8.49
Iberia Parish Sheriff's Office	Iberia	LA	242	6	24.79	8.19
Madison County Sheriff's Office	Madison	MO	8	1	125.00	8.18
Blackford County Sheriff's Office	Blackford	IN	8	1	125.00	7.83
Big Horn County Sheriff's Office	Big Horn	MT	8	1	125.00	7.77
Jackson County Sheriff's Office	Jackson	KS	15	1	66.67	7.43
Davie County Sheriff's Office	Davie	NC	45	3	66.67	7.27
Walton County Sheriff's Office	Walton	FL	165	4	24.24	7.27
Clarke County Sheriff's Office	Clarke	VA	18	1	55.56	7.13
Zapata County Sheriff's Office	Zapata	TX	44	1	22.73	7.13
Del Norte County Sheriff's Office	Del Norte	CA	30	2	66.67	6.99
Marlboro County Sheriff's Office	Marlboro	SC	25	2	80.00	6.91
Long County Sheriff's Office	Long	GA	15	1	66.67	6.91
Calhoun County Sheriff's Office	Calhoun	FL	18	1	55.56	6.84
Nye County Sheriff's Office	Nye	NV	108	3	27.78	6.83
Estill County Sheriff's Office	Estill	KY	5	1	200.00	6.82
Oglethorpe County Sheriff's Office	Oglethorpe	GA	19	1	52.63	6.71
Kingfisher County Sheriff's Office	Kingfisher	OK	8	1	125.00	6.65
Winn Parish Sheriff's Office	Winn	LA	23	1	43.48	6.53
St. John The Baptist Parish Sheriff's Office	St. John the Baptist	LA	150	3	20.00	6.53
Clay County Sheriff's Office	Clay	AR	7	1	142.86	6.22
Floyd County Sheriff's Office	Floyd	IA	11	1	90.91	6.13

Dewitt County Sheriff's Office	De Witt	IL	16	1	62.50	6.04
Pawnee County Sheriff's Office	Pawnee	OK	19	1	52.63	6.03
Henry County Sheriff's Office	Henry	AL	8	1	125.00	5.78
Simpson County Sheriff's Office	Simpson	KY	11	1	90.91	5.77
Benzie County Sheriff's Office	Benzie	MI	13	1	76.92	5.71
Socorro County Sheriff's Office	Socorro	NM	10	1	100.00	5.60
Cross County Sheriff's Office	Cross	AR	17	1	58.82	5.60
Clayton County Sheriff's Office	Clayton	IA	12	1	83.33	5.52
Haywood County Sheriff's Office	Haywood	TN	22	1	45.45	5.32
Lee County Sheriff's Office	Lee	SC	28	1	35.71	5.20
Lincoln County Sheriff's Office	Lincoln	NC	98	4	40.82	5.11
Nez Perce County Sheriff's Office	Nez Perce	ID	25	2	80.00	5.09
Montague County Sheriff's Office	Montague	TX	10	1	100.00	5.07
Polk County Sheriff's Office	Polk	GA	27	2	74.07	4.82
Warren County Sheriff's Office	Warren	NC	30	1	33.33	4.77
Hampton County Sheriff's Office	Hampton	SC	26	1	38.46	4.74
Phillips County Sheriff's Office	Phillips	AR	16	1	62.50	4.60
McDowell County Sheriff's Office	McDowell	WV	15	1	66.67	4.52
Gage County Sheriff's Office	Gage	NE	12	1	83.33	4.48
Perry County Sheriff's Office	Perry	IL	12	1	83.33	4.47
Thomas County Sheriff's Office	Thomas	GA	47	2	42.55	4.47
Stephens County Sheriff's Office	Stephens	OK	11	2	181.82	4.44
Hempstead County Sheriff's Office	Hempstead	AR	13	1	76.92	4.42
Bibb County Sheriff's Office	Bibb	AL	12	1	83.33	4.36
Plaquemines Parish Sheriff's Office	Plaquemines	LA	145	1	6.90	4.34
Franklin County Sheriff's Office	Franklin	IN	12	1	83.33	4.33
Hancock County Sheriff's Office	Hancock	IN	40	3	75.00	4.29
Osceola County Sheriff's Office	Osceola	MI	18	1	55.56	4.25
Routt County Sheriff's Office	Routt	CO	22	1	45.45	4.25
Page County Sheriff's Office	Page	VA	49	1	20.41	4.16
Stark County Sheriff's Office	Stark	ND	11	1	90.91	4.13
Monroe County Sheriff's Office	Monroe	FL	189	3	15.87	4.10
Martin County Sheriff's Office	Martin	NC	34	1	29.41	4.08
Miller County Sheriff's Office	Miller	MO	16	1	62.50	4.04
Saline County Sheriff's Office	Saline	IL	42	1	23.81	4.01
Dearborn County Sheriff's Office	Dearborn	IN	29	2	68.97	4.00

Luna County Sheriff's Office	Luna	NM	30	1	33.33	3.98
White County Sheriff's Office	White	TN	28	1	35.71	3.87
Stephens County Sheriff's Office	Stephens	GA	31	1	32.26	3.82
Vernon Parish Sheriff's Office	Vernon	LA	64	2	31.25	3.82
San Jacinto County Sheriff's Office	San Jacinto	TX	21	1	47.62	3.79
Russell County Sheriff's Office	Russell	AL	32	2	62.50	3.78
Juneau County Sheriff's Office	Juneau	WI	45	1	22.22	3.75
Clay County Sheriff's Office	Clay	IN	30	1	33.33	3.72
White County Sheriff's Office	White	GA	40	1	25.00	3.68
Hardeman County Sheriff's Office	Hardeman	TN	22	1	45.45	3.67
Custer County Sheriff's Office	Custer	OK	12	1	83.33	3.64
Cherokee County Sheriff's Office	Cherokee	SC	48	2	41.67	3.61
Madison County Sheriff's Office	Madison	GA	34	1	29.41	3.56
Lenoir County Sheriff's Office	Lenoir	NC	58	2	34.48	3.36
Daviess County Sheriff's Office	Daviess	IN	19	1	52.63	3.16
Lafourche Parish Sheriff's Office	Lafourche	LA	287	3	10.45	3.11
Lake County Sheriff's Office	Lake	CA	61	2	32.79	3.09
Emmet County Sheriff's Office	Emmet	MI	23	1	43.48	3.06
Dallas County Sheriff's Office	Dallas	IA	23	2	86.96	3.02
Accomack County Sheriff's Office	Accomack	VA	27	1	37.04	3.02
Williamson County Sheriff's Office	Williamson	IL	29	2	68.97	3.01
Randolph County Sheriff's Office	Randolph	IL	13	1	76.92	2.99
Bolivar County Sheriff's Office	Bolivar	MS	18	1	55.56	2.93
Bedford County Sheriff's Office	Bedford	VA	77	2	25.97	2.91
Walker County Sheriff's Office	Walker	GA	80	2	25.00	2.91
Morgan County Sheriff's Office	Morgan	IN	26	2	76.92	2.90
Chambers County Sheriff's Office	Chambers	TX	44	1	22.73	2.85
Forsyth County Sheriff's Office	Forsyth	GA	253	5	19.76	2.85
Isle of Wight County Sheriff's Office	Isle of Wight	VA	40	1	25.00	2.84
Greenbrier County Sheriff's Office	Greenbrier	WV	30	1	33.33	2.82
Whitley County Sheriff's Office	Whitley	KY	12	1	83.33	2.81
St. Bernard Parish Sheriff's Office	St. Bernard	LA	189	1	5.29	2.79
Putnam County Sheriff's Office	Putnam	TN	58	2	34.48	2.77
Jefferson Parish Sheriff's Office	Jefferson	LA	825	12	14.55	2.77
Halifax County Sheriff's Office	Halifax	VA	29	1	34.48	2.76
Nassau County Sheriff's Office	Nassau	FL	109	2	18.35	2.73

Graham County Sheriff's Office	Graham	AZ	23	1	43.48	2.69
Liberty County Sheriff's Office	Liberty	TX	37	2	54.05	2.64
Woodford County Sheriff's Office	Woodford	IL	37	1	27.03	2.59
Bossier Parish Sheriff's Office	Bossier	LA	300	3	10.00	2.56
Hendry County Sheriff's Office	Hendry	FL	67	1	14.93	2.55
Harrison County Sheriff's Office	Harrison	IN	22	1	45.45	2.54
Upshur County Sheriff's Office	Upshur	TX	45	1	22.22	2.54
Ravalli County Sheriff's Office	Ravalli	MT	29	1	34.48	2.49
Richmond County Sheriff's Office	Richmond	GA	449	5	11.14	2.49
Rio Arriba County Sheriff's Office	Rio Arriba	NM	22	1	45.45	2.48
Burleigh County Sheriff's Office	Burleigh	ND	40	2	50.00	2.46
Jim Wells County Sheriff's Office	Jim Wells	TX	27	1	37.04	2.45
New York City Sheriff's Office	New York	NY	120	2	16.67	2.44
Okanogan County Sheriff's Office	Okanogan	WA	30	1	33.33	2.43
Baxter County Sheriff's Office	Baxter	AR	32	1	31.25	2.41
Greene County Sheriff's Office	Greene	AR	15	1	66.67	2.38
Holmes County Sheriff's Office	Holmes	OH	33	1	30.30	2.36
Orleans County Sheriff's Office	Orleans	NY	29	1	34.48	2.33
Barnstable County Sheriff's Office	Barnstable	MA	254	5	19.69	2.32
Grand Traverse County Sheriff's Office	Grand Traverse	MI	64	2	31.25	2.30
Monroe County Sheriff's Office	Monroe	WI	23	1	43.48	2.24
Robeson County Sheriff's Office	Robeson	NC	128	3	23.44	2.24
Lincoln County Sheriff's Office	Lincoln	SD	17	1	58.82	2.23
McDowell County Sheriff's Office	McDowell	NC	40	1	25.00	2.22
Lawrence County Sheriff's Office	Lawrence	IN	25	1	40.00	2.17
Campbell County Sheriff's Office	Campbell	WY	58	1	17.24	2.17
Lincoln County Sheriff's Office	Lincoln	OR	65	1	15.38	2.17
Indian River County Sheriff's Office	Indian River	FL	226	3	13.27	2.17
Polk County Sheriff's Office	Polk	FL	600	13	21.67	2.16
Chesterfield County Sheriff's Office	Chesterfield	SC	41	1	24.39	2.14
Lincoln Parish Sheriff's Office	Lincoln	LA	46	1	21.74	2.14
Hoke County Sheriff's Office	Hoke	NC	50	1	20.00	2.13
Douglas County Sheriff's Office	Douglas	NV	100	1	10.00	2.13
Queen Anne's County Sheriff's Office	Queen Annes	MD	50	1	20.00	2.09
Flagler County Sheriff's Office	Flagler	FL	130	2	15.38	2.09
Newaygo County Sheriff's Office	Newaygo	MI	25	1	40.00	2.06

Elko County Sheriff's Office	Elko	NV	57	1	17.54	2.05
Columbia County Sheriff's Office	Columbia	OR	41	1	24.39	2.03
Shelby County Sheriff's Office	Shelby	OH	30	1	33.33	2.02
Jackson County Sheriff's Office	Jackson	FL	61	1	16.39	2.01
Dale County Sheriff's Office	Dale	AL	0	1		1.99
Bibb County Sheriff's Office	Bibb	GA	290	3	10.34	1.93
St. Martin Parish Sheriff's Office	St. Martin	LA	45	1	22.22	1.92
Pender County Sheriff's Office	Pender	NC	57	1	17.54	1.92
St. Charles Parish Sheriff's Office	St. Charles	LA	291	1	3.44	1.89
Charlotte County Sheriff's Office	Charlotte	FL	285	3	10.53	1.88
Collier County Sheriff's Office	Collier	FL	628	6	9.55	1.87
Brunswick County Sheriff's Office	Brunswick	NC	114	2	17.54	1.86
Columbiana County Sheriff's Office	Columbiana	OH	22	2	90.91	1.85
San Benito County Sheriff's Office	San Benito	CA	29	1	34.48	1.81
Saline County Sheriff's Office	Saline	KS	44	1	22.73	1.80
Tuscola County Sheriff's Office	Tuscola	MI	25	1	40.00	1.79
Terrebonne Parish Sheriff's Office	Terrebonne	LA	300	2	6.67	1.79
Pitt County Sheriff's Office	Pitt	NC	125	3	24.00	1.78
Franklin County Sheriff's Office	Franklin	VA	78	1	12.82	1.78
Marion County Sheriff's Office	Marion	WV	27	1	37.04	1.77
Hawkins County Sheriff's Office	Hawkins	TN	42	1	23.81	1.76
Lee County Sheriff's Office	Lee	NC	47	1	21.28	1.73
Okaloosa County Sheriff's Office	Okaloosa	FL	258	3	11.63	1.66
Potter County Sheriff's Office	Potter	TX	93	2	21.51	1.65
Stanly County Sheriff's Office	Stanly	NC	49	1	20.41	1.65
Starr County Sheriff's Office	Starr	TX	31	1	32.26	1.64
Wayne County Sheriff's Office	Wayne	NC	85	2	23.53	1.63
Kershaw County Sheriff's Office	Kershaw	SC	61	1	16.39	1.62
Acadia Parish Sheriff's Office	Acadia	LA	105	1	9.52	1.62
Crawford County Sheriff's Office	Crawford	AR	27	1	37.04	1.61
Columbia County Sheriff's Office	Columbia	GA	206	2	9.71	1.61
Sauk County Sheriff's Office	Sauk	WI	118	1	8.47	1.61
Otero County Sheriff's Office	Otero	NM	30	1	33.33	1.57
Clay County Sheriff's Office	Clay	FL	284	3	10.56	1.57
San Juan County Sheriff's Office	San Juan	NM	94	2	21.28	1.54
Harrison County Sheriff's Office	Harrison	TX	45	1	22.22	1.52

Salem County Sheriff's Office	Salem	NJ	157	1	6.37	1.51
Laurens County Sheriff's Office	Laurens	SC	65	1	15.38	1.50
New Hanover County Sheriff's Office	New Hanover	NC	315	3	9.52	1.48
Darlington County Sheriff's Office	Darlington	SC	64	1	15.63	1.46
Barrow County Sheriff's Office	Barrow	GA	127	1	7.87	1.44
Grant County Sheriff's Office	Grant	IN	45	1	22.22	1.43
DeKalb County Sheriff's Office	DeKalb	AL	34	1	29.41	1.41
Muskogee County Sheriff's Office	Muskogee	OK	37	1	27.03	1.41
McKinley County Sheriff's Office	McKinley	NM	35	1	28.57	1.40
Orange County Sheriff's Office	Orange	FL	1398	16	11.44	1.40
Bullitt County Sheriff's Office	Bullitt	KY	40	1	25.00	1.35
Valencia County Sheriff's Office	Valencia	NM	37	1	27.03	1.31
Rockingham County Sheriff's Office	Rockingham	VA	46	1	21.74	1.31
Kern County Sheriff's Office	Kern	CA	512	11	21.48	1.31
Lancaster County Sheriff's Office	Lancaster	SC	93	1	10.75	1.30
Sullivan County Sheriff's Office	Sullivan	NY	44	1	22.73	1.29
Rock County Sheriff's Office	Rock	WI	94	2	21.28	1.25
Cullman County Sheriff's Office	Cullman	AL	78	1	12.82	1.24
Manatee County Sheriff's Office	Manatee	FL	476	4	8.40	1.24
Porter County Sheriff's Office	Porter	IN	61	2	32.79	1.22
Passaic County Sheriff's Office	Passaic	NJ	530	6	11.32	1.20
St. Croix County Sheriff's Office	St. Croix	WI	44	1	22.73	1.19
Bay County Sheriff's Office	Bay	FL	213	2	9.39	1.18
Washtenaw County Sheriff's Office	Washtenaw	MI	133	4	30.08	1.16
Ozaukee County Sheriff's Office	Ozaukee	WI	83	1	12.05	1.16
Orleans Parish Sheriff's Office (Criminal Division)	Orleans	LA	505	4	7.92	1.16
Wood County Sheriff's Office	Wood	WV	40	1	25.00	1.15
Charleston County Sheriff's Office	Charleston	SC	259	4	15.44	1.14
Lee County Sheriff's Office	Lee	FL	621	7	11.27	1.13
St. Joseph County Sheriff's Office	St. Joseph	IN	116	3	25.86	1.12
Livingston County Sheriff's Office	Livingston	MI	65	2	30.77	1.11
Hall County Sheriff's Office	Hall	GA	257	2	7.78	1.11
Burke County Sheriff's Office	Burke	NC	86	1	11.63	1.10
Carver County Sheriff's Office	Carver	MN	87	1	11.49	1.10
Williamson County Sheriff's Office	Williamson	TN	99	2	20.20	1.09
Leon County Sheriff's Office	Leon	FL	443	3	6.77	1.09

Orangeburg County Sheriff's Office	Orangeburg	SC	92	1	10.87	1.08
Pottawattamie County Sheriff's Office	Pottawattomie	IA	50	1	20.00	1.07
Anderson County Sheriff's Office	Anderson	SC	191	2	10.47	1.07
Sutter County Sheriff's Office	Sutter	CA	105	1	9.52	1.06
Steuben County Sheriff's Office	Steuben	NY	26	1	38.46	1.01
Lake County Sheriff's Office	Lake	IN	170	5	29.41	1.01
Yamhill County Sheriff's Office	Yamhill	OR	36	1	27.78	1.01
Lake County Sheriff's Office	Lake	FL	286	3	10.49	1.01
Escambia County Sheriff's Office	Escambia	FL	388	3	7.73	1.01
Highlands County Sheriff's Office	Highlands	FL	130	1	7.69	1.01
Wicomico County Sheriff's Office	Wicomico	MD	0	1		1.01
Lenawee County Sheriff's Office	Lenawee	MI	44	1	22.73	1.00
Newton County Sheriff's Office	Newton	GA	152	1	6.58	1.00
Pennington County Sheriff's Office	Pennington	SD	65	1	15.38	0.99
Richmond (City) Sheriff's Office	Richmond City	VA	424	2	4.72	0.98
Whitfield County Sheriff's Office	Whitfield	GA	115	1	8.70	0.97
Washoe County Sheriff's Office	Washoe	NV	414	4	9.66	0.95
St. Mary's County Sheriff's Office	St. Marys	MD	120	1	8.33	0.95
Vigo County Sheriff's Office	Vigo	IN	38	1	26.32	0.93
Eaton County Sheriff's Office	Eaton	MI	77	1	12.99	0.93
Broward County Sheriff's Office	Broward	FL	1624	16	9.85	0.92
Lowndes County Sheriff's Office	Lowndes	GA	145	1	6.90	0.92
Clark County Sheriff's Office	Clark	IN	35	1	28.57	0.91
Lucas County Sheriff's Office	Lucas	OH	289	4	13.84	0.91
Marion County Sheriff's Office	Marion	FL	349	3	8.60	0.91
Palm Beach County Sheriff's Office	Palm Beach	FL	1447	12	8.29	0.91
La Porte County Sheriff's Office	La Porte	IN	58	1	17.24	0.90
Allegan County Sheriff's Office	Allegan	MI	59	1	16.95	0.90
Chesapeake (City) Sheriff's Office	Chesapeake City	VA	358	2	5.59	0.90
La Salle County Sheriff's Office	La Salle	IL	36	1	27.78	0.88
Wilson County Sheriff's Office	Wilson	TN	202	1	4.95	0.88
La Crosse County Sheriff's Office	La Crosse	WI	43	1	23.26	0.87
Pinellas County Sheriff's Office	Pinellas	FL	863	8	9.27	0.87
Shelby County Sheriff's Office	Shelby	TN	516	8	15.50	0.86
Pasco County Sheriff's Office	Pasco	FL	485	4	8.25	0.86
St. Tammany Parish Sheriff's Office	St. Tammany	LA	409	2	4.89	0.86

Morgan County Sheriff's Office	Morgan	AL	55	1	18.18	0.84
Boone County Sheriff's Office	Boone	KY	130	1	7.69	0.84
Denver County Sheriff's Office	Denver	CO	739	5	6.77	0.83
Yakima County Sheriff's Office	Yakima	WA	69	2	28.99	0.82
Washington County Sheriff's Office	Washington	TN	86	1	11.63	0.81
Volusia County Sheriff's Office	Volusia	FL	450	4	8.89	0.81
Hillsborough County Sheriff's Office	Hillsborough	FL	1223	10	8.18	0.81
Coweta County Sheriff's Office	Coweta	GA	137	1	7.30	0.79
Hunterdon County Sheriff's Office	Hunterdon	NJ	17	1	58.82	0.78
Livingston Parish Sheriff's Office	Livingston	LA	125	1	8.00	0.78
Richland County Sheriff's Office	Richland	SC	512	3	5.86	0.78
Marion County Sheriff's Office	Marion	IN	740	7	9.46	0.77
Sandoval County Sheriff's Office	Sandoval	NM	45	1	22.22	0.76
Rutherford County Sheriff's Office	Rutherford	TN	189	2	10.58	0.76
Rapides Parish Sheriff's Office	Rapides	LA	212	1	4.72	0.76
Dauphin County Sheriff's Office	Dauphin	PA	36	2	55.56	0.75
Marathon County Sheriff's Office	Marathon	WI	67	1	14.93	0.75
Orange County Sheriff's Office	Orange	NC	115	1	8.70	0.75
Milwaukee County Sheriff's Office	Milwaukee	WI	524	7	13.36	0.74
San Luis Obispo County Sheriff's Office	San Luis Obispo	CA	156	2	12.82	0.74
Osceola County Sheriff's Office	Osceola	FL	388	2	5.15	0.74
St. Lucie County Sheriff's Office	St. Lucie	FL	259	2	7.72	0.72
Clark County Sheriff's Office	Clark	OH	134	1	7.46	0.72
Polk County Sheriff's Office	Polk	IA	143	3	20.98	0.70
Spartanburg County Sheriff's Office	Spartanburg	SC	297	2	6.73	0.70
Paulding County Sheriff's Office	Paulding	GA	175	1	5.71	0.70
Santa Fe County Sheriff's Office	Santa Fe	NM	75	1	13.33	0.69
Yellowstone County Sheriff's Office	Yellowstone	MT	55	1	18.18	0.68
Washington County Sheriff's Office	Washington	MD	94	1	10.64	0.68
East Baton Rouge Parish Sheriff's Office	East Baton Rouge	LA	359	3	8.36	0.68
Tulare County Sheriff's Office	Tulare	CA	513	3	5.85	0.68
Martin County Sheriff's Office	Martin	FL	414	1	2.42	0.68
Madera County Sheriff's Office	Madera	CA	78	1	12.82	0.66
Santa Rosa County Sheriff's Office	Santa Rosa	FL	190	1	5.26	0.66
Centre County Sheriff's Office	Centre	PA	17	1	58.82	0.65
Hidalgo County Sheriff's Office	Hidalgo	TX	262	5	19.08	0.65

McHenry County Sheriff's Office	McHenry	IL	134	2	14.93	0.65
Catawba County Sheriff's Office	Catawba	NC	126	1	7.94	0.65
Ouachita Parish Sheriff's Office	Ouachita	LA	431	1	2.32	0.65
Sullivan County Sheriff's Office	Sullivan	TN	183	1	5.46	0.64
Loudoun County Sheriff's Office	Loudoun	VA	448	2	4.46	0.64
Kent County Sheriff's Office	Kent	DE	5	1	200.00	0.62
Luzerne County Sheriff's Office	Luzerne	PA	38	2	52.63	0.62
Portage County Sheriff's Office	Portage	OH	66	1	15.15	0.62
Beaufort County Sheriff's Office	Beaufort	SC	209	1	4.78	0.62
Kenosha County Sheriff's Office	Kenosha	WI	122	1	8.20	0.60
Minnehaha County Sheriff's Office	Minnehaha	SD	69	1	14.49	0.59
Hamilton County Sheriff's Office	Hamilton	TN	146	2	13.70	0.59
Johnston County Sheriff's Office	Johnston	NC	97	1	10.31	0.59
Hernando County Sheriff's Office	Hernando	FL	249	1	4.02	0.58
Montgomery County Sheriff's Office	Montgomery	TN	287	1	3.48	0.58
Outagamie County Sheriff's Office	Outagamie	WI	74	1	13.51	0.57
Delaware County Sheriff's Office	Delaware	OH	86	1	11.63	0.57
Forsyth County Sheriff's Office	Forsyth	NC	217	2	9.22	0.57
Ulster County Sheriff's Office	Ulster	NY	57	1	17.54	0.55
St. Charles County Sheriff's Office	St. Charles	MO	153	2	13.07	0.55
San Bernardino County Sheriff's Office	San Bernardino	CA	1797	11	6.12	0.54
Harrison County Sheriff's Office	Harrison	MS	90	1	11.11	0.53
Pinal County Sheriff's Office	Pinal	AZ	218	2	9.17	0.53
Clackamas County Sheriff's Office	Clackamas	OR	319	2	6.27	0.53
Calcasieu Parish Sheriff's Office	Calcasieu	LA	592	1	1.69	0.52
Saginaw County Sheriff's Office	Saginaw	MI	71	1	14.08	0.50
Union County Sheriff's Office	Union	NC	170	1	5.88	0.50
Riverside County Sheriff's Office	Riverside	CA	2147	11	5.12	0.50
Middlesex County Sheriff's Department	Middlesex	NJ	170	4	23.53	0.49
Cameron County Sheriff's Office	Cameron	TX	107	2	18.69	0.49
Mesilla Marshal's Office	Dona Ana	NM	5	1	200.00	0.48
Smith County Sheriff's Office	Smith	TX	88	1	11.36	0.48
Hudson County Sheriff's Office	Hudson	NJ	221	3	13.57	0.47
Williamson County Sheriff's Office	Williamson	TX	206	2	9.71	0.47
Orange County Sheriff-Coroner Department	Orange	CA	1794	14	7.80	0.47
Seminole County Sheriff's Office	Seminole	FL	355	2	5.63	0.47

Niagara County Sheriff's Office	Niagara	NY	110	1	9.09	0.46
Bernalillo County Sheriff's Office	Bernalillo	NM	279	3	10.75	0.45
Benton County Sheriff's Office	Benton	AR	103	1	9.71	0.45
Butte County Sheriff's Office	Butte	CA	110	1	9.09	0.45
Clay County Sheriff's Office	Clay	MO	115	1	8.70	0.45
Adams County Sheriff's Office	Adams	CO	364	2	5.49	0.45
Wake County Sheriff's Office	Wake	NC	354	4	11.30	0.44
Greenville County Sheriff's Office	Greenville	SC	397	2	5.04	0.44
Fulton County Sheriff's Office	Fulton	GA	516	4	7.75	0.43
Frederick County Sheriff's Office	Frederick	MD	177	1	5.65	0.43
Spokane County Sheriff's Office	Spokane	WA	244	2	8.20	0.42
Sacramento County Sheriff's Office	Sacramento	CA	1409	6	4.26	0.42
Dane County Sheriff's Office	Dane	WI	454	2	4.41	0.41
Harford County Sheriff's Office	Harford	MD	280	1	3.57	0.41
Norfolk (City) Sheriff's Office	Norfolk City	VA	414	1	2.42	0.41
St. Louis County Sheriff's Office	St. Louis	MO	200	4	20.00	0.40
Monroe County Sheriff's Office	Monroe	NY	273	3	10.99	0.40
Kitsap County Sheriff's Office	Kitsap	WA	121	1	8.26	0.40
Weld County Sheriff's Office	Weld	CO	121	1	8.26	0.40
Marin County Sheriff's Office	Marin	CA	202	1	4.95	0.40
Alachua County Sheriff's Office	Alachua	FL	276	1	3.62	0.40
Cleveland County Sheriff's Office	Cleveland	OK	70	1	14.29	0.39
Ramsey County Sheriff's Office	Ramsey	MN	235	2	8.51	0.39
Horry County Sheriff's Office	Horry	SC	55	1	18.18	0.37
Gwinnett County Sheriff's Office	Gwinnett	GA	531	3	5.65	0.37
Brevard County Sheriff's Office	Brevard	FL	497	2	4.02	0.37
Delaware County Sheriff's Office	Delaware	PA	58	2	34.48	0.36
Hamilton County Sheriff's Office	Hamilton	IN	64	1	15.63	0.36
Atlantic County Sheriff's Office	Atlantic	NJ	103	1	9.71	0.36
Prince George's County Sheriff's Office	Prince Georges	MD	233	3	12.88	0.35
Arapahoe County Sheriff's Office	Arapahoe	CO	407	2	4.91	0.35
Winnebago County Sheriff's Office	Winnebago	IL	142	1	7.04	0.34
Boulder County Sheriff's Office	Boulder	CO	174	1	5.75	0.34
Galveston County Sheriff's Office	Galveston	TX	240	1	4.17	0.34
Bucks County Sheriff's Office	Bucks	PA	50	2	40.00	0.32
Baltimore (City) Sheriff's Office	Baltimore City	MD	99	2	20.20	0.32

Brazoria County Sheriff's Office	Brazoria	TX	127	1	7.87	0.32
Chesterfield County Sheriff's Office	Chesterfield	VA	225	1	4.44	0.32
Marion County Sheriff's Office	Marion	OR	255	1	3.92	0.32
Madison County Sheriff's Office	Madison	AL	107	1	9.35	0.30
Anoka County Sheriff's Office	Anoka	MN	133	1	7.52	0.30
Bexar County Sheriff's Office	Bexar	TX	526	5	9.51	0.29
DeKalb County Sheriff's Office	DeKalb	GA	325	2	6.15	0.29
Placer County Sheriff's Office	Placer	CA	228	1	4.39	0.29
Snohomish County Sheriff's Office	Snohomish	WA	287	2	6.97	0.28
Fairfax County Sheriff's Office	Fairfax	VA	499	3	6.01	0.28
Orange County Sheriff's Office	Orange	NY	99	1	10.10	0.27
Westmoreland County Sheriff's Office	Westmoreland	PA	0	1		0.27
King County Sheriff's Office	King	WA	721	5	6.93	0.26
Waukesha County Sheriff's Office	Waukesha	WI	150	1	6.67	0.26
Sarasota County Sheriff's Office	Sarasota	FL	409	1	2.44	0.26
Allegheny County Sheriff's Office	Allegheny	PA	151	3	19.87	0.25
Prince William County Sheriff's Office	Prince William	VA	75	1	13.33	0.25
Dakota County Sheriff's Office	Dakota	MN	77	1	12.99	0.25
El Paso County Sheriff's Office	El Paso	TX	248	2	8.06	0.25
Pierce County Sheriff's Office	Pierce	WA	292	2	6.85	0.25
Solano County Sheriff's Office	Solano	CA	113	1	8.85	0.24
Santa Barbara County Sheriff's Office	Santa Barbara	CA	294	1	3.40	0.24
Cuyahoga County Sheriff's Office	Cuyahoga	OH	141	3	21.28	0.23
San Diego County Sheriff's Office	San Diego	CA	1322	7	5.30	0.23
Knox County Sheriff's Office	Knox	TN	456	1	2.19	0.23
Onondaga County Sheriff's Office	Onondaga	NY	242	1	4.13	0.21
Morris County Sheriff's Office	Morris	NJ	262	1	3.82	0.20
Kane County Sheriff's Office	Kane	IL	92	1	10.87	0.19
Montgomery County Sheriff's Office	Montgomery	OH	222	1	4.50	0.19
Stanislaus County Sheriff's Office	Stanislaus	CA	230	1	4.35	0.19
Summit County Sheriff's Office	Summit	OH	393	1	2.54	0.18
Franklin County Sheriff's Office	Franklin	OH	455	2	4.40	0.17
El Paso County Sheriff's Office	El Paso	CO	454	1	2.20	0.16
Monmouth County Sheriff's Office	Monmouth	NJ	494	1	2.02	0.16
Cobb County Sheriff's Office	Cobb	GA	435	1	2.30	0.15
Will County Sheriff's Office	Will	IL	445	1	2.25	0.15

Cook County Sheriff's Office	Cook	IL	5655	8	1.41	0.15
Lake County Sheriff's Office	Lake	IL	188	1	5.32	0.14
Los Angeles County Sheriff's Office	Los Angeles	CA	9461	14	1.48	0.14
Alameda County Sheriff's Office	Alameda	CA	928	2	2.16	0.13
Baltimore County Sheriff's Office	Baltimore	MD	84	1	11.90	0.12
Macomb County Sheriff's Office	Macomb	MI	245	1	4.08	0.12
Hamilton County Sheriff's Office	Hamilton	OH	330	1	3.03	0.12
Ventura County Sheriff's Office	Ventura	CA	755	1	1.32	0.12
Fresno County Sheriff's Office	Fresno	CA	461	1	2.17	0.11
Pima County Sheriff's Dept.	Pima	AZ	554	1	1.81	0.10
Contra Costa County Sheriff's Office	Contra Costa	CA	679	1	1.47	0.10
Harris County Sheriff's Office	Harris	TX	2558	3	1.17	0.07
Santa Clara County Sheriff's Office	Santa Clara	CA	450	1	2.22	0.06
Maricopa County Sheriff's Office	Maricopa	AZ	766	2	2.61	0.05
Wayne County Sheriff's Office	Wayne	MI	1062	1	0.94	0.05
Dade County Sheriff's Office	Dade	GA	25	1	40.00	0.04
Dallas County Sheriff's Office	Dallas	TX	449	1	2.23	0.04

Appendix C-5. County Police Departments in Study: Rates of Officers Arrested, 2005-2011 (Sorted by Rate per 100,000 Population)

Agency	County	State	# of Full-Time Sworn Personnel	Per Agency	Per 1,000 Officers	Per 100,000 Population
Polk County Police Department	Polk	GA	35	3	85.71	7.23
Kauai (County) Police Department	Kauai	HI	125	3	24.00	4.47
Indianapolis Police	Marion	IN	1582	33	20.86	3.65
Horry County Police Department	Horry	SC	243	9	37.04	3.34
Oldham County Police Department	Oldham	KY	31	2	64.52	3.32
Maui (County) Police Department	Maui	HI	329	5	15.20	3.23
Honolulu (City and County) Police Department	Honolulu	HI	1934	26	13.44	2.73
Savannah-Chatham Metropolitan Police Department	Chatham	GA	534	6	11.24	2.26
Prince George's County Police Department	Prince Georges	MD	1578	19	12.04	2.20
Roanoke County Police Department	Roanoke	VA	135	2	14.81	2.17
Charlotte - Mecklenburg Police Department	Mecklenburg	NC	1672	20	11.96	2.17
Dougherty County Police Dept.	Dougherty	GA	47	2	42.55	2.11
DeKalb County Police Department	DeKalb	GA	1074	13	12.10	1.88
Athens-Clarke County Police Dept	Clarke	GA	213	2	9.39	1.71
Montgomery County Police Department	Montgomery	MD	1206	16	13.27	1.65
James City County Police Dept.	James City	VA	94	1	10.64	1.49
Riley County Police Department	Riley	KS	101	1	9.90	1.41
Henrico County Division of Police	Henrico	VA	554	4	7.22	1.30
Clayton County Police Department	Clayton	GA	336	3	8.93	1.16
Floyd County Police Department	Floyd	GA	71	1	14.08	1.04
Howard County Police Department	Howard	MD	424	3	7.08	1.04
Miami-Dade (County) Police Department	Miami-Dade	FL	3093	25	8.08	1.00
Gaston County Police Department	Gaston	NC	133	2	15.04	0.97
Prince William County Police Department	Prince William	VA	546	3	5.49	0.75
Cobb County Police Department	Cobb	GA	590	5	8.47	0.73
Fairfax County Police Department	Fairfax	VA	1419	7	4.93	0.65
Anne Arundel County Police Department	Anne Arundel	MD	633	3	4.74	0.56
Gwinnett County Police Department	Gwinnett	GA	682	4	5.87	0.50
Baltimore County Police Department	Baltimore	MD	1910	4	2.09	0.50
Henry County Police Department	Henry	GA	225	1	4.44	0.49
Arlington County Police Department	Arlington	VA	364	1	2.75	0.48
Nassau County Police Department	Nassau	NY	2732	6	2.20	0.45

Suffolk County Police Department	Suffolk	NY	2622	6	2.29	0.40
New Castle County Police Department	New Castle	DE	358	2	5.59	0.37
Westchester County Department of Public Safety	Westchester	NY	270	3	11.11	0.32
Chesterfield County Police Department	Chesterfield	VA	475	1	2.11	0.32
Fulton County Police Department	Fulton	GA	129	2	15.50	0.22
St. Louis County Police Dept	St. Louis	MO	781	2	2.56	0.20
Allegheny County Police Department.	Allegheny	PA	202	2	9.90	0.16

Appendix C-6. 500 Largest Municipal Police Departments in Study: Rates of Officers Arrested, 2005-2011 (Sorted by Rate per 100,000 Population)

Agency	County	State	# of Full-Time Sworn Personnel	Per Agency	Per 1,000 Officers	Per 100,000 Population
New Orleans Police Department	Orleans	LA	1425	63	44.21	18.32
Portsmouth Police Department	Portsmouth City	VA	235	10	42.55	10.47
Baltimore Police Department	Baltimore City	MD	2990	55	18.39	8.86
Milwaukee Police Department	Milwaukee	WI	1987	73	36.74	7.70
Clarksville Police Department	Montgomery	TN	238	5	21.01	7.54
Kansas City Police Department	Wyandotte	KS	354	10	28.25	6.35
Petersburg Police Department	Petersburg City	VA	82	2	24.39	6.17
Macon Police Department	Bibb	GA	270	9	33.33	5.79
Norfolk Police Department	Norfolk City	VA	772	14	18.13	5.77
Muskogee Police Department	Muskogee	OK	90	4	44.44	5.63
Newport News Police Department	Newport News City	VA	415	10	24.10	5.53
Schenectady Police Department	Schenectady	NY	166	8	48.19	5.17
Memphis Police Department	Shelby	TN	1549	46	29.70	4.96
Washington Metropolitan Police Dept	District of Columbia	DC	3742	29	7.75	4.82
Shreveport Police Department	Caddo	LA	511	12	23.48	4.71
Charleston Police Department	Kanawha	WV	182	9	49.45	4.66
Wheeling Police Department	Ohio	WV	84	2	23.81	4.50
Philadelphia Police Department	Philadelphia	PA	6624	66	9.96	4.33
Albany Police Department	Dougherty	GA	184	4	21.74	4.23
Chattanooga Police Department	Hamilton	TN	434	14	32.26	4.16
Jackson Police Department	Madison	TN	204	4	19.61	4.07
Cleveland Police Department	Bradley	TN	89	4	44.94	4.04
Greenville Police Department	Washington	MS	96	2	20.83	3.91
Farmington Police Department	San Juan	NM	129	5	38.76	3.84
Meridian Police Department	Lauderdale	MS	99	3	30.30	3.74
Jackson Police Department	Hinds	MS	480	9	18.75	3.67
Richmond Police Department	Richmond City	VA	752	7	9.31	3.43
Waco Police Department	McLennan	TX	246	8	32.52	3.41
Durham Police Department	Durham	NC	494	9	18.22	3.36
Dubuque Police Department	Dubuque	IA	100	3	30.00	3.20
Columbus Police Department	Muscogee	GA	400	6	15.00	3.16

St. Louis (city) Police Dept	St. Louis City	MO	1351	10	7.40	3.13
Waterloo Police Department	Black Hawk	IA	120	4	33.33	3.05
Anderson Police	Madison	IN	117	4	34.19	3.04
South Bend Police	St. Joseph	IN	255	8	31.37	3.00
Nashville Metro Police Department	Davidson	TN	1315	18	13.69	2.87
Sumter Police Department	Sumter	SC	107	3	28.04	2.79
Toledo Police Department	Lucas	OH	640	12	18.75	2.72
Hattiesburg Police Department	Forrest	MS	126	2	15.87	2.67
Montgomery Police Department	Montgomery	AL	500	6	12.00	2.62
Bossier City Police Dept	Bossier	LA	178	3	16.85	2.56
Muncie Police	Delaware	IN	102	3	29.41	2.55
Pueblo Police Dept	Pueblo	CO	195	4	20.51	2.51
Wilson Police Department	Wilson	NC	114	2	17.54	2.46
New York City Police Department	New York	NY	36023	196	5.44	2.40
Fort Smith Police Department	Sebastian	AR	158	3	18.99	2.39
Atlanta Police Department	Fulton	GA	1719	22	12.80	2.39
Albany Police Department	Albany	NY	328	7	21.34	2.30
Victoria Police Department	Victoria	TX	106	2	18.87	2.30
Charlottesville Police Dept.	Charlottesville City	VA	115	1	8.70	2.30
Topeka Police Department	Shawnee	KS	283	4	14.13	2.25
Denver Police Department	Denver	CO	1525	13	8.52	2.17
Louisville Metro Police Department	Jefferson	KY	1197	16	13.37	2.16
Alexandria Police Department	Alexandria City	VA	315	3	9.52	2.14
Cleveland Police Department	Cuyahoga	OH	1616	27	16.71	2.11
Columbia Police Department	Richland	SC	351	8	22.79	2.08
Roanoke City Police Department	Roanoke City	VA	264	2	7.58	2.06
Virginia Beach Police Department	Virginia Beach City	VA	813	9	11.07	2.05
Gary Police	Lake	IN	243	10	41.15	2.02
Elkhart Police	Elkhart	IN	124	4	32.26	2.02
Burlington Police Department	Alamance	NC	105	3	28.57	1.99
Rapid City Police Department	Pennington	SD	107	2	18.69	1.98
Dothan Police Department	Houston	AL	148	2	13.51	1.97
Albuquerque Police Department	Bernalillo	NM	1020	13	12.75	1.96
Camden Police	Camden	NJ	397	10	25.19	1.95
Springfield Police Department	Hampden	MA	464	9	19.40	1.94
Ocean City Police Department	Worcester	MD	107	1	9.35	1.94

Boston Police Department	Suffolk	MA	2181	14	6.42	1.94
Kingsport Police Department	Sullivan	TN	111	3	27.03	1.91
Murfreesboro Police Department	Rutherford	TN	213	5	23.47	1.90
Jersey City Police	Hudson	NJ	900	12	13.33	1.89
Scranton Police Department	Lackawanna	PA	155	4	25.81	1.87
El Paso Police Department	El Paso	TX	1132	15	13.25	1.87
Myrtle Beach Police Department	Horry	SC	179	5	27.93	1.86
New Braunfels Police Department	Comal	TX	92	2	21.74	1.84
Norwich Police Department	New London	CT	81	5	61.73	1.82
Tulsa Police Department	Tulsa	OK	826	11	13.32	1.82
Cranston Police Department	Providence	RI	148	3	20.27	1.81
Lubbock Police Department	Lubbock	TX	376	5	13.30	1.79
Broomfield Police Department	Broomfield	CO	105	1	9.52	1.79
Rocky Mount Police Department	Nash	NC	143	1	6.99	1.77
San Antonio Police Department	Bexar	TX	2020	30	14.85	1.75
Sanford Police Department	Lee	NC	81	1	12.35	1.73
Pittsburgh Police Department	Allegheny	PA	891	21	23.57	1.72
Oklahoma City Police Department	Oklahoma	OK	1046	12	11.47	1.67
Evansville Police	Vanderburgh	IN	277	3	10.83	1.67
Lorain Police Department	Lorain	OH	100	5	50.00	1.66
Dallas Police Department	Dallas	TX	3389	39	11.51	1.65
Trenton Police	Mercer	NJ	361	6	16.62	1.64
Gainesville Police Department	Alachua	FL	275	4	14.55	1.62
Anderson Police Department	Anderson	SC	91	3	32.97	1.60
Laredo Police Department	Webb	TX	430	4	9.30	1.60
Chicago Police Dept	Cook	IL	13354	83	6.22	1.60
St. Paul Police Department	Ramsey	MN	598	8	13.38	1.57
Danville Police Department	Pittsylvania	VA	126	1	7.94	1.57
Minneapolis Police Department	Hennepin	MN	902	18	19.96	1.56
Wichita Falls Police Department	Wichita	TX	177	2	11.30	1.52
LaGrange Police Department	Troup	GA	83	1	12.05	1.49
Akron Police Department	Summit	OH	472	8	16.95	1.48
Florence Police Department	Florence	SC	109	2	18.35	1.46
Hampton Police Department	Hampton City	VA	232	2	8.62	1.46
Fort Pierce Police Department	St. Lucie	FL	126	4	31.75	1.44
North Charleston Police Department	Charleston	SC	325	5	15.38	1.43

Flint Police Department	Genesee	MI	204	6	29.41	1.41
Niagara Falls Police Department	Niagara	NY	145	3	20.69	1.39
Des Moines Police Department	Polk	IA	385	6	15.58	1.39
Santa Fe Police Department	Santa Fe	NM	150	2	13.33	1.39
Jacksonville Sheriff's Office	Duval	FL	1662	12	7.22	1.39
Anchorage Police Department	Anchorage	AK	372	4	10.75	1.37
Grand Junction Police Department	Mesa	CO	108	2	18.52	1.36
Portland Police Bureau	Multnomah	OR	928	10	10.78	1.36
Baton Rouge Police Department	East Baton Rouge	LA	630	6	9.52	1.36
Billings Police Department	Yellowstone	MT	138	2	14.49	1.35
Chesapeake Police Department	Chesapeake City	VA	376	3	7.98	1.35
Bethlehem Police Department	Northampton	PA	154	4	25.97	1.34
Jefferson City Police Department	Cole	MO	88	1	11.36	1.32
Pine Bluff Police Department	Jefferson	AR	140	1	7.14	1.29
Bend Police Department	Deschutes	OR	86	2	23.26	1.27
Spokane Police Department	Spokane	WA	295	6	20.34	1.27
Vineland Police	Cumberland	NJ	157	2	12.74	1.27
Detroit Police Department	Wayne	MI	2250	23	10.22	1.26
Cincinnati Police Department	Hamilton	OH	1082	10	9.24	1.25
Dover Police Department	Kent	DE	90	2	22.22	1.23
Daytona Beach Police Department	Volusia	FL	250	6	24.00	1.21
Middletown Police Department	Middlesex	CT	99	2	20.20	1.21
Kokomo Police	Howard	IN	100	1	10.00	1.21
Birmingham Police Department	Jefferson	AL	816	8	9.80	1.21
Tupelo Police Department	Lee	MS	115	1	8.70	1.21
Bloomington Police Dept	McLean	IL	122	2	16.39	1.18
Suffolk Police Department	Suffolk	VA	171	1	5.85	1.18
Ann Arbor Police Department	Washtenaw	MI	160	4	25.00	1.16
Omaha Police Dept	Douglas	NE	747	6	8.03	1.16
Fort Wayne Police	Allen	IN	447	4	8.95	1.13
Hartford Police Department	Hartford	CT	408	10	24.51	1.12
Kissimmee Police Department	Osceola	FL	136	3	22.06	1.12
Providence Police Department	Providence	RI	483	7	14.49	1.12
St. Joseph Police Dept	Buchanan	MO	114	1	8.77	1.12
Fort Worth Police Department	Tarrant	TX	1489	20	13.43	1.11
Carmel Police	Hamilton	IN	104	3	28.85	1.09

Springfield Police Dept	Greene	MO	306	3	9.80	1.09
Florence Police Department	Lauderdale	AL	94	1	10.64	1.08
Texarkana Police Department	Bowie	TX	94	1	10.64	1.08
Portland Police Department	Cumberland	ME	159	3	18.87	1.07
Biloxi Police Department	Harrison	MS	133	2	15.04	1.07
Lansing Police Department	Ingham	MI	240	3	12.50	1.07
Council Bluffs Police Department	Pottawattomie	IA	105	1	9.52	1.07
Aurora Police Department	Arapahoe	CO	627	6	9.57	1.05
Lake Charles Police Department	Calcasieu	LA	153	2	13.07	1.04
Yuma Police Department	Yuma	AZ	167	2	11.98	1.02
Greensboro Police Department	Guilford	NC	593	5	8.43	1.02
Newark Police	Essex	NJ	1310	8	6.11	1.02
Salisbury Police Department	Wicomico	MD	88	1	11.36	1.01
Eau Claire Police Department	Eau Claire	WI	96	1	10.42	1.01
Fort Collins Police Department	Larimer	CO	162	3	18.52	1.00
Hackensack Police	Bergen	NJ	117	9	76.92	0.99
Wilmington Police Department	New Hanover	NC	266	2	7.52	0.99
Medford Police Department	Jackson	OR	103	2	19.42	0.98
Fayetteville Police Department	Washington	AR	117	2	17.09	0.98
Austin Police Department	Travis	TX	1515	10	6.60	0.98
Elgin Police Dept	Kane	IL	181	5	27.62	0.97
Modesto Police Department	Stanislaus	CA	262	5	19.08	0.97
Killeen Police Department	Bell	TX	190	3	15.79	0.97
Gastonia Police Department	Gaston	NC	166	2	12.05	0.97
New Bern Police Department	Craven	NC	90	1	11.11	0.97
Mobile Police Department	Mobile	AL	515	4	7.77	0.97
Salinas Police Department	Monterey	CA	177	4	22.60	0.96
Idaho Falls Police Department	Bonneville	ID	89	1	11.24	0.96
Bakersfield Police Department	Kern	CA	348	8	22.99	0.95
Cedar Rapids Police Department	Linn	IA	197	2	10.15	0.95
Plainfield Police Department	Union	NJ	151	5	33.11	0.93
New Haven Police Department	New Haven	CT	436	8	18.35	0.93
Barnstable Police Department	Barnstable	MA	110	2	18.18	0.93
Valdosta Police Department	Lowndes	GA	133	1	7.52	0.92
Chico Police Department	Butte	CA	88	2	22.73	0.91
Westminster Police Dept	Adams	CO	178	4	22.47	0.91

Missoula Police Department	Missoula	MT	100	1	10.00	0.91
Michigan City Police	La Porte	IN	86	1	11.63	0.90
Huntsville Police Department	Madison	AL	405	3	7.41	0.90
Decatur Police Dept	Macon	IL	166	1	6.02	0.90
Greenville Police Department	Greenville	SC	178	4	22.47	0.89
Raleigh Police Department	Wake	NC	702	8	11.40	0.89
Corpus Christi Police Department	Nueces	TX	448	3	6.70	0.88
San Francisco Police Department	San Francisco	CA	1940	7	3.61	0.87
Edison Police	Middlesex	NJ	189	7	37.04	0.86
Ogden Police Department	Weber	UT	137	2	14.60	0.86
Houston Police Department	Harris	TX	5053	35	6.93	0.86
Winston-Salem Police Department	Forsyth	NC	508	3	5.91	0.86
Utica Police Department	Oneida	NY	179	2	11.17	0.85
Joplin Police Department	Jasper	MO	92	1	10.87	0.85
Decatur Police Department	Morgan	AL	133	1	7.52	0.84
Lakeland Police Department	Polk	FL	226	5	22.12	0.83
Goldsboro Police Department	Wayne	NC	101	1	9.90	0.82
Johnson City Police Department	Washington	TN	146	1	6.85	0.81
Lawton Police Department	Comanche	OK	165	1	6.06	0.81
Colorado Springs Police Department	El Paso	CO	668	5	7.49	0.80
Greeley Police Department	Weld	CO	146	2	13.70	0.79
Beaumont Police Department	Jefferson	TX	246	2	8.13	0.79
Columbus Police Department	Franklin	OH	1886	9	4.77	0.77
Fresno Police Department	Fresno	CA	828	7	8.45	0.75
Flagstaff Police Department	Coconino	AZ	113	1	8.85	0.74
Kansas City Police Department	Jackson	MO	1421	5	3.52	0.74
New London Police Department	New London	CT	90	2	22.22	0.73
Egg Harbor Township Police	Atlantic	NJ	95	2	21.05	0.73
Midland Police Department	Midland	TX	153	1	6.54	0.73
Salisbury Police Department	Rowan	NC	86	1	11.63	0.72
Springfield Police Department	Clark	OH	127	1	7.87	0.72
Reno Police Department	Washoe	NV	362	3	8.29	0.71
Orlando Police Department	Orange	FL	757	8	10.57	0.70
Texas City Police Department	Galveston	TX	85	2	23.53	0.69
Rochester Police Department	Olmsted	MN	125	1	8.00	0.69
Moline Police Department	Rock Island	IL	85	1	11.76	0.68

Hagerstown Police Department	Washington	MD	105	1	9.52	0.68
Elyria Police Department	Lorain	OH	86	2	23.26	0.66
Colonie Town Police Department	Albany	NY	109	2	18.35	0.66
Edinburg Police Department	Hidalgo	TX	110	5	45.45	0.65
Fort Myers Police Department	Lee	FL	170	4	23.53	0.65
St. Petersburg Police Department	Pinellas	FL	510	6	11.76	0.65
Hickory Police Department	Catawba	NC	114	1	8.77	0.65
Monroe Police Department	Ouachita	LA	188	1	5.32	0.65
Woonsocket Police Department	Providence	RI	99	4	40.40	0.64
San Marcos Police Department	Hays	TX	95	1	10.53	0.64
Syracuse Police Department	Onondaga	NY	489	3	6.13	0.64
Bellevue Police Dept	Sarpy	NE	92	1	10.87	0.63
Worcester Police Department	Worcester	MA	482	5	10.37	0.63
Covington Police Department	Kenton	KY	112	1	8.93	0.63
Troy Police Department	Rensselaer	NY	121	1	8.26	0.63
Fayetteville Police Department	Cumberland	NC	341	2	5.87	0.63
Brockton Police Department	Plymouth	MA	197	3	15.23	0.61
Columbia Police Department	Boone	MO	155	1	6.45	0.61
Tucson Police Department	Pima	AZ	1032	6	5.81	0.61
Ocala Police Department	Marion	FL	155	2	12.90	0.60
Paterson Police	Passaic	NJ	497	3	6.04	0.60
Panama City Police Department	Bay	FL	86	1	11.63	0.59
Sioux Falls Police Department	Minnehaha	SD	221	1	4.52	0.59
Provo Police Department	Utah	UT	99	3	30.30	0.58
Lafayette Police	Tippecanoe	IN	128	1	7.81	0.58
Kennewick Police Department	Benton	WA	90	1	11.11	0.57
Charleston Police Department	Charleston	SC	382	2	5.24	0.57
Miami Police Department	Miami-Dade	FL	1104	14	12.68	0.56
Redding Police Department	Shasta	CA	118	1	8.47	0.56
Concord Police Department	Cabarrus	NC	153	1	6.54	0.56
Norwalk Police Department	Fairfield	CT	167	5	29.94	0.55
Greece Town Police Department	Monroe	NY	94	4	42.55	0.54
Lawrence Police Department	Essex	MA	151	4	26.49	0.54
Peoria Police Dept	Peoria	IL	246	1	4.07	0.54
Boynton Beach Police Department	Palm Beach	FL	165	7	42.42	0.53
Gulfport Police Department	Harrison	MS	193	1	5.18	0.53

Little Rock Police Department	Pulaski	AR	520	2	3.85	0.52
Boise Police Department	Ada	ID	306	2	6.54	0.51
San Jose Police Department	Santa Clara	CA	1382	9	6.51	0.51
Racine Police Department	Racine	WI	195	1	5.13	0.51
Tuscaloosa Police Department	Tuscaloosa	AL	263	1	3.80	0.51
Springfield Police Dept	Sangamon	IL	273	1	3.66	0.51
Saginaw Police Department	Saginaw	MI	92	1	10.87	0.50
Champaign Police Dept	Champaign	IL	122	1	8.20	0.50
Binghamton Police Department	Broome	NY	139	1	7.19	0.50
Las Cruces Police Department	Dona Ana	NM	167	1	5.99	0.48
Hoboken Police	Hudson	NJ	156	3	19.23	0.47
Union City Police	Hudson	NJ	165	3	18.18	0.47
Seattle Police Department	King	WA	1283	9	7.01	0.47
Hollywood Police Department	Broward	FL	316	8	25.32	0.46
Waterbury Police Department	New Haven	CT	256	4	15.63	0.46
Riviera Beach Police Department	Palm Beach	FL	108	6	55.56	0.45
Enfield Police Department	Hartford	CT	95	4	42.11	0.45
Brookline Police Department	Norfolk	MA	129	3	23.26	0.45
Rogers Police Department	Benton	AR	99	1	10.10	0.45
Phoenix Police Department	Maricopa	AZ	3388	17	5.02	0.45
Lafayette Police Department	Lafayette	LA	243	1	4.12	0.45
Bolingbrook Police Dept	Will	IL	122	3	24.59	0.44
Conroe Police Department	Montgomery	TX	99	2	20.20	0.44
Joliet Police Dept	Will	IL	302	3	9.93	0.44
Rock Hill Police Department	York	SC	121	1	8.26	0.44
Buffalo Police Department	Erie	NY	793	4	5.04	0.44
Mentor Police Department	Lake	OH	82	1	12.20	0.43
Frederick Police Department	Frederick	MD	138	1	7.25	0.43
Yakima Police Department	Yakima	WA	134	1	7.46	0.41
Las Vegas Metro Police Department	Clark	NV	2942	8	2.72	0.41
Port Orange Police Department	Volusia	FL	83	2	24.10	0.40
East Chicago Police	Lake	IN	110	2	18.18	0.40
Rochester Police Department	Monroe	NY	703	3	4.27	0.40
Kalamazoo Dept of Public Safety	Kalamazoo	MI	244	1	4.10	0.40
Wichita Police Department	Sedgwick	KS	662	2	3.02	0.40
Gloucester Township Police	Camden	NJ	111	2	18.02	0.39

Cherry Hill Police	Camden	NJ	145	2	13.79	0.39
Lancaster Police Department	Lancaster	PA	161	2	12.42	0.39
McAllen Police Department	Hidalgo	TX	273	3	10.99	0.39
Merced Police Department	Merced	CA	105	1	9.52	0.39
San Diego Police Department	San Diego	CA	1951	12	6.15	0.39
East Orange Police	Essex	NJ	283	3	10.60	0.38
Ottawa County Sheriff's Office	Ottawa	MI	115	1	8.70	0.38
Tacoma Police Department	Pierce	WA	371	3	8.09	0.38
Elk Grove Police Department	Sacramento	CA	126	1	7.94	0.38
Cuyahoga Falls Police Department	Summit	OH	86	2	23.26	0.37
Belleville Police Dept	St. Clair	IL	81	1	12.35	0.37
Wilmington Police Department	New Castle	DE	306	2	6.54	0.37
Harrisburg Police Department	Dauphin	PA	155	1	6.45	0.37
Oxnard Police Department	Ventura	CA	228	3	13.16	0.36
New Bedford Police Department	Bristol	MA	288	2	6.94	0.36
Erie Police Department	Erie	PA	167	1	5.99	0.36
Port St. Lucie Police Department	St. Lucie	FL	245	1	4.08	0.36
Tallahassee Police Department	Leon	FL	364	1	2.75	0.36
Washington Township Police	Gloucester	NJ	86	1	11.63	0.35
Sacramento Police Department	Sacramento	CA	701	5	7.13	0.35
Lincoln Police Dept	Lancaster	NE	308	1	3.25	0.35
Sugar Land Police Department	Fort Bend	TX	130	2	15.38	0.34
Fort Lauderdale Police Department	Broward	FL	482	6	12.45	0.34
Poughkeepsie Police Department	Dutchess	NY	105	1	9.52	0.34
Longmont Police Department	Boulder	CO	136	1	7.35	0.34
Pensacola Police Department	Escambia	FL	146	1	6.85	0.34
Galveston Police Department	Galveston	TX	161	1	6.21	0.34
Boulder Police Department	Boulder	CO	165	1	6.06	0.34
Rockford Police Dept	Winnebago	IL	300	1	3.33	0.34
Stratford Police Department	Fairfield	CT	111	3	27.03	0.33
Sandy Springs Police Department	Fulton	GA	120	3	25.00	0.33
Broken Arrow Police Department	Tulsa	OK	124	2	16.13	0.33
Stamford Police Department	Fairfield	CT	292	3	10.27	0.33
Bridgeport Police Department	Fairfield	CT	422	3	7.11	0.33
Pawtucket Police Department	Providence	RI	153	2	13.07	0.32
Orangetown Town Police Department	Rockland	NY	90	1	11.11	0.32

Cape Coral Police Department	Lee	FL	220	2	9.09	0.32
Ramapo Town Police Department	Rockland	NY	120	1	8.33	0.32
Salem Police Department	Marion	OR	187	1	5.35	0.32
Wilkes Barre City Police Department	Luzerne	PA	92	1	10.87	0.31
Los Angeles Police Department	Los Angeles	CA	9727	30	3.08	0.31
Richmond Police Department	Contra Costa	CA	165	3	18.18	0.29
Mount Pleasant Police Department	Charleston	SC	137	1	7.30	0.29
Allentown Police Department	Lehigh	PA	200	1	5.00	0.29
Stockton Police Department	San Joaquin	CA	415	2	4.82	0.29
Edmond Police Department	Oklahoma	OK	110	2	18.18	0.28
Waukegan Police Dept	Lake	IL	155	2	12.90	0.28
O'Fallon Police Department	St. Charles	MO	107	1	9.35	0.28
St. Charles Police Dept	St. Charles	MO	112	1	8.93	0.28
Salem Police Department	Essex	MA	83	2	24.10	0.27
Lynn Police Department	Essex	MA	178	2	11.24	0.27
West Chester Police Department	Butler	OH	90	1	11.11	0.27
Newburgh City Police Department	Orange	NY	105	1	9.52	0.27
Hamilton Police Department	Butler	OH	135	1	7.41	0.27
Canton Police Department	Stark	OH	172	1	5.81	0.27
Pharr Police Department	Hidalgo	TX	96	2	20.83	0.26
Allen Police Department	Collin	TX	106	2	18.87	0.26
Mission Police Department	Hidalgo	TX	125	2	16.00	0.26
Irvington Police	Essex	NJ	190	2	10.53	0.26
New Brunswick Police	Middlesex	NJ	138	2	14.49	0.25
Harlingen Police Department	Cameron	TX	123	1	8.13	0.25
Nashua Police Department	Hillsborough	NH	172	1	5.81	0.25
Manchester Police Department	Hillsborough	NH	218	1	4.59	0.25
Brownsville Police Department	Cameron	TX	230	1	4.35	0.25
Vacaville Police Department	Solano	CA	111	1	9.01	0.24
Altamonte Springs Police Department	Seminole	FL	124	1	8.06	0.24
Sanford Police Department	Seminole	FL	131	1	7.63	0.24
Round Rock Police Department	Williamson	TX	133	1	7.52	0.24
Santa Barbara Police Department	Santa Barbara	CA	136	1	7.35	0.24
Tampa Police Department	Hillsborough	FL	980	3	3.06	0.24
Parma Police Department	Cuyahoga	OH	92	3	32.61	0.23
Hamden Police Department	New Haven	CT	105	2	19.05	0.23

West Haven Police Department	New Haven	CT	122	2	16.39	0.23
West Palm Beach Police Department	Palm Beach	FL	310	3	9.68	0.23
York Police Department	York	PA	110	1	9.09	0.23
Visalia Department of Public Safety	Tulare	CA	136	1	7.35	0.23
Kenner Police Department	Jefferson	LA	162	1	6.17	0.23
Dearborn Police Department	Wayne	MI	198	4	20.20	0.22
Pinellas Park Police Department	Pinellas	FL	99	2	20.20	0.22
East Point Police Department	Fulton	GA	116	2	17.24	0.22
Manchester Police Department	Hartford	CT	116	2	17.24	0.22
New Britain Police Department	Hartford	CT	160	2	12.50	0.22
Holyoke Police Department	Hampden	MA	123	1	8.13	0.22
Chicopee Police Department	Hampden	MA	133	1	7.52	0.22
New Rochelle Police Department	Westchester	NY	185	2	10.81	0.21
Yonkers Police Department	Westchester	NY	641	2	3.12	0.21
Wayne Township Police	Passaic	NJ	117	1	8.55	0.20
Clifton Police	Passaic	NJ	158	1	6.33	0.20
Oakland Police Department	Alameda	CA	773	3	3.88	0.20
Madison Police Department	Dane	WI	437	1	2.29	0.20
West Jordan Police Department	Salt Lake	UT	102	2	19.61	0.19
Orem Department of Public Safety	Utah	UT	90	1	11.11	0.19
Beaverton Police Department	Washington	OR	124	1	8.06	0.19
Elizabeth Police	Union	NJ	348	1	2.87	0.19
Dayton Police Department	Montgomery	OH	421	1	2.38	0.19
Titusville Police Department	Brevard	FL	88	1	11.36	0.18
Riverside Police Department	Riverside	CA	385	4	10.39	0.18
Palm Bay Police Department	Brevard	FL	159	1	6.29	0.18
Olathe Police Department	Johnson	KS	161	1	6.21	0.18
Melbourne Police Department	Brevard	FL	163	1	6.13	0.18
Fall River Police Department	Bristol	MA	237	1	4.22	0.18
Coconut Creek Police Department	Broward	FL	89	3	33.71	0.17
Brick Township Police	Ocean	NJ	127	1	7.87	0.17
Arlington Police Department	Tarrant	TX	610	3	4.92	0.17
Grand Rapids Police Department	Kent	MI	319	1	3.13	0.17
East Providence Police Department	Providence	RI	98	1	10.20	0.16
Bensalem Township Police Department	Bucks	PA	104	1	9.62	0.16
West New York Police	Hudson	NJ	119	1	8.40	0.16

North Bergen Police	Hudson	NJ	123	1	8.13	0.16
Palm Beach Gardens Police Department	Palm Beach	FL	114	2	17.54	0.15
Weymouth Police Department	Norfolk	MA	96	1	10.42	0.15
Marietta Police Department	Cobb	GA	133	1	7.52	0.15
Denton Police Department	Denton	TX	155	1	6.45	0.15
Quincy Police Department	Norfolk	MA	205	1	4.88	0.15
Independence Police Department	Jackson	MO	206	1	4.85	0.15
Folsom Police Department	Sacramento	CA	88	2	22.73	0.14
Revere Police Department	Suffolk	MA	86	1	11.63	0.14
Chelsea Police Department	Suffolk	MA	92	1	10.87	0.14
Daly City Police Department	San Mateo	CA	113	1	8.85	0.14
Gresham Police Department	Multnomah	OR	129	1	7.75	0.14
Everett Police Department	Snohomish	WA	198	1	5.05	0.14
Alameda Police Department	Alameda	CA	94	2	21.28	0.13
San Leandro Police Department	Alameda	CA	95	2	21.05	0.13
Oceanside Police Department	San Diego	CA	210	4	19.05	0.13
Somerville Police Department	Middlesex	MA	130	2	15.38	0.13
Haverhill Police Department	Essex	MA	93	1	10.75	0.13
Lakewood Police Department	Pierce	WA	103	1	9.71	0.13
Lowell Police Department	Middlesex	MA	239	2	8.37	0.13
Plano Police Department	Collin	TX	343	1	2.92	0.13
Homestead Police Department	Miami-Dade	FL	106	3	28.30	0.12
Pasadena Police Department	Harris	TX	260	5	19.23	0.12
North Brunswick Police	Middlesex	NJ	83	1	12.05	0.12
Piscataway Township Police	Middlesex	NJ	90	1	11.11	0.12
Milford Police Department	New Haven	CT	110	1	9.09	0.12
Meriden Police Department	New Haven	CT	113	1	8.85	0.12
Miami Beach Police Department	Miami-Dade	FL	374	3	8.02	0.12
Woodbridge Police	Middlesex	NJ	206	1	4.85	0.12
Warren Police Department	Macomb	MI	230	1	4.35	0.12
Santa Clara Police Department	Santa Clara	CA	141	2	14.18	0.11
Downers Grove Police Dept	Du Page	IL	81	1	12.35	0.11
Davie Police Department	Broward	FL	164	2	12.20	0.11
Miramar Police Department	Broward	FL	171	2	11.70	0.11
College Park Police Department	Fulton	GA	93	1	10.75	0.11
Bartlett Police Department	Shelby	TN	105	1	9.52	0.11

Bristol Police Department	Hartford	CT	119	1	8.40	0.11
Largo Police Department	Pinellas	FL	140	1	7.14	0.11
Danbury Police Department	Fairfield	CT	153	1	6.54	0.11
Naperville Police Dept	Du Page	IL	184	1	5.43	0.11
Mount Vernon Police Department	Westchester	NY	205	1	4.88	0.11
White Plains Police Department	Westchester	NY	210	1	4.76	0.11
Clearwater Police Department	Pinellas	FL	255	1	3.92	0.11
Fullerton Police Department	Orange	CA	159	3	18.87	0.10
Oro Valley Police Department	Pima	AZ	103	1	9.71	0.10
Sandy Police Department	Salt Lake	UT	110	1	9.09	0.10
Anaheim Police Department	Orange	CA	398	3	7.54	0.10
Concord Police Department	Contra Costa	CA	161	1	6.21	0.10
Henderson Police Department	Clark	NV	336	2	5.95	0.10
San Bernardino Police Department	San Bernardino	CA	345	2	5.80	0.10
West Valley City Police Department	Salt Lake	UT	186	1	5.38	0.10
North Las Vegas Police Department	Clark	NV	471	2	4.25	0.10
Salt Lake County Sheriff's Office	Salt Lake	UT	342	1	2.92	0.10
Salt Lake City Police Department	Salt Lake	UT	433	1	2.31	0.10
Apopka Police Department	Orange	FL	85	1	11.76	0.09
Cicero Police Dept	Cook	IL	146	4	27.40	0.08
West Bloomfield Township Police Dept	Oakland	MI	81	1	12.35	0.08
Royal Oak Police Department	Oakland	MI	85	1	11.76	0.08
Coral Gables Police Department	Miami-Dade	FL	184	2	10.87	0.08
Euclid Police Department	Cuyahoga	OH	100	1	10.00	0.08
Jupiter Police Department	Palm Beach	FL	102	1	9.80	0.08
Delray Beach Police Department	Palm Beach	FL	152	1	6.58	0.08
Irving Police Department	Dallas	TX	344	2	5.81	0.08
Westminster Police Department	Orange	CA	100	2	20.00	0.07
Citrus Heights Police Department	Sacramento	CA	83	1	12.05	0.07
Garden Grove Police Department	Orange	CA	166	2	12.05	0.07
Pleasanton Police Department	Alameda	CA	85	1	11.76	0.07
Southampton Town Police Department	Suffolk	NY	102	1	9.80	0.07
Medford Police Department	Middlesex	MA	110	1	9.09	0.07
Hempstead Village Police Department	Nassau	NY	112	1	8.93	0.07
Framingham Police Department	Middlesex	MA	118	1	8.47	0.07
Newton Police Department	Middlesex	MA	136	1	7.35	0.07

Fremont Police Department	Alameda	CA	182	1	5.49	0.07
Hayward Police Department	Alameda	CA	185	1	5.41	0.07
Berkeley Police Department	Alameda	CA	186	1	5.38	0.07
Cambridge Police Department	Middlesex	MA	272	1	3.68	0.07
Berwyn Police Dept	Cook	IL	105	3	28.57	0.06
Eulesse Police Department	Tarrant	TX	83	1	12.05	0.06
Grapevine Police Department	Tarrant	TX	90	1	11.11	0.06
Palo Alto Police Department	Santa Clara	CA	93	1	10.75	0.06
Lauderhill Police Department	Broward	FL	115	1	8.70	0.06
Sunrise Police Department	Broward	FL	175	1	5.71	0.06
Pembroke Pines Police Department	Broward	FL	238	1	4.20	0.06
Palm Springs Police Department	Riverside	CA	93	1	10.75	0.05
Federal Way Police Department	King	WA	133	1	7.52	0.05
Chandler Police Department	Maricopa	AZ	333	2	6.01	0.05
Mesa Police Department	Maricopa	AZ	831	2	2.41	0.05
Tinley Park Police Dept	Cook	IL	81	2	24.69	0.04
Mesquite Police Department	Dallas	TX	226	1	4.42	0.04
Long Beach Police Department	Los Angeles	CA	968	4	4.13	0.04
Hialeah Police Department	Miami-Dade	FL	338	1	2.96	0.04
El Cajon Police Department	San Diego	CA	120	1	8.33	0.03
Surprise Police Department	Maricopa	AZ	127	1	7.87	0.03
Newport Beach Police Department	Orange	CA	140	1	7.14	0.03
Costa Mesa Police Department	Orange	CA	158	1	6.33	0.03
Peoria Police Department	Maricopa	AZ	189	1	5.29	0.03
Irvine Police Department	Orange	CA	197	1	5.08	0.03
Huntington Beach Police Department	Orange	CA	223	1	4.48	0.03
Chula Vista Police Department	San Diego	CA	244	1	4.10	0.03
Tempe Police Department	Maricopa	AZ	357	1	2.80	0.03
Scottsdale Police Dept	Maricopa	AZ	417	1	2.40	0.03
Calumet City Police Dept	Cook	IL	91	1	10.99	0.02
Des Plaines Police Dept	Cook	IL	102	1	9.80	0.02
Oak Lawn Police Dept	Cook	IL	106	1	9.43	0.02
Oak Park Police Dept	Cook	IL	115	1	8.70	0.02
Baytown Police Department	Harris	TX	136	1	7.35	0.02
Alhambra Police Department	Los Angeles	CA	83	1	12.05	0.01
Redondo Beach Police Department	Los Angeles	CA	99	1	10.10	0.01

Inglewood Police Department	Los Angeles	CA	187	1	5.35	0.01
Glendale Police Department	Los Ange+B468les	CA	264	1	3.79	0.01

Appendix C-7. Special State & Local Law Enforcement Agencies in Study: Rates of Officers Arrested, 2005-2011 (Sorted by Rate per 100,000 Population)

Agency	County	State	# of Full-Time Sworn Personnel	Per Agency	Per 1,000 Officers	Per 100,000 Population
University of Tennessee at Knoxville Police	Knox	TN	52	2	38.46	10.47
University of West Alabama Police	Sumter	AL	6	1	166.67	7.27
Tuskegee University Police Department	Macon	AL	33	1	30.30	4.66
Grambling State University Police Dept.	Lincoln	LA	9	2	222.22	4.28
University of Maryland Eastern Shore Public Safety	Somerset	MD	6	1	166.67	3.78
Georgia Public Safety Training Center	Monroe	GA	19	1	52.63	3.78
Ohio Dept of Natural Resources - Ofc. of Law Enf.	Franklin	OH	394	2	5.08	3.24
Virginia Marine Resources Commission	Newport News City	VA	60	1	16.67	3.02
BYU-Idaho Police Department	Madison	ID	10	1	100.00	2.66
Missouri Univ. of Science & Technology Police Dept	Phelps	MO	11	1	90.91	2.21
Appalachian State University Police Dept	Watauga	NC	25	1	40.00	1.96
Lander University Public Safety	Greenwood	SC	10	1	100.00	1.44
Central Michigan University Police Department	Isabella	MI	21	1	47.62	1.42
Morrisville State College Police	Madison	NY	11	1	90.91	1.36
Missouri Department of Corrections	Cole	MO	13	1	76.92	1.32
New York City Dept of Environmental Protection Police	Westchester	NY	168	1	5.95	1.29
Mississippi Department of Wildlife, Fisheries & Parks	Hinds	MS	230	1	4.35	1.05
Arkansas State University Police Dept.	Craighead	AR	17	1	58.82	1.04
Virginia Commonwealth University Police Dept.	Richmond City	VA	74	2	27.03	0.98
Northern Illinois University Police	DeKalb	IL	59	1	16.95	0.95
Pennsylvania Dept of Conservation & Natural Resources	Dauphin	PA	136	1	7.35	0.79
Midland I.S.D. Police Dept.	Midland	TX	11	1	90.91	0.73
University of Pittsburgh at Johnstown Police	Cambria	PA	13	1	76.92	0.70
New Mexico Department Of Game & Fish	Santa Fe	NM	106	1	9.43	0.69
Ennis I.S.D. Police Department	Ellis	TX	5	1	200.00	0.67
Delaware River & Bay Authority Police	New Castle	DE	50	1	20.00	0.51
Medical College of Georgia	Richmond	GA	32	1	31.25	0.50
University of Illinois Police Dept	Champaign	IL	54	1	18.52	0.50
New Jersey Transit Police	Essex	NJ	201	3	14.93	0.47
Florida Fish & Wildlife Conservation Commission	Leon	FL	626	4	6.39	0.44
Connally I.S.D. Police Dept.	McLennan	TX	3	1	333.33	0.43

Shippensburg University of Pennsylvania Police	Cumberland	PA	17	1	58.82	0.42
Maryland National Capital Park Police - Montgomery Co	Montgomery	MD	86	1	11.63	0.41
Beaumont I.S.D. Police Dept.	Jefferson	TX	22	1	45.45	0.40
Volusia County Beach Patrol	Volusia	FL	60	2	33.33	0.40
United I.S.D. Police Dept.	Webb	TX	51	1	19.61	0.40
University of Florida Police	Alachua	FL	85	1	11.76	0.40
Louisiana State Univ. Health Sciences Center Police Dept	Caddo	LA	49	1	20.41	0.39
St. Joseph County Airport Police	St. Joseph	IN	17	1	58.82	0.37
Duke University Police Department	Durham	NC	60	1	16.67	0.37
University of South Carolina - Upstate Police Dept	Spartanburg	SC	12	1	83.33	0.35
Lafayette College Office of Public Safety	Northampton	PA	18	1	55.56	0.34
Anchorage International Airport Police	Anchorage	AK	65	1	15.38	0.34
State University at Albany Police	Albany	NY	41	1	24.39	0.33
Washington Metropolitan Area Transit Auth. Police	District of Columbia	DC	442	2	4.52	0.33
Tennessee State University	Davidson	TN	27	2	74.07	0.32
Palm Beach County School District Police	Palm Beach	FL	176	4	22.73	0.30
Lehigh-Northampton Airport Auth. Police Dept	Lehigh	PA	9	1	111.11	0.29
Medical University of South Carolina Public Safety	Charleston	SC	62	1	16.13	0.29
Indiana University Purdue U. Fort Wayne U. Police	Allen	IN	18	1	55.56	0.28
Massachusetts Dept of Mental Health Police Dept	Suffolk	MA	40	2	50.00	0.28
MBTA Transit Police	Suffolk	MA	256	2	7.81	0.28
Kentucky Alcoholic Beverage Control	Franklin	KY	30	2	66.67	0.27
University of Arkansas Medical Sciences Dept of Pub	Pulaski	AR	36	1	27.78	0.26
South Carolina Dept of Mental Health-Public Safety	Richland	SC	120	1	8.33	0.26
South Carolina Department of Natural Resources	Richland	SC	238	1	4.20	0.26
Santa Rosa I.S.D. Police Department	Cameron	TX	3	1	333.33	0.25
Cameron Co. District Attorney Investigations Div	Cameron	TX	30	1	33.33	0.25
Southern University and A & M College Police	East Baton Rouge	LA	43	1	23.26	0.23
Louisiana State University Police Department	East Baton Rouge	LA	62	1	16.13	0.23
Greenville Technical College Public Safety	Greenville	SC	9	1	111.11	0.22
New York State Park Police	Albany	NY	305	1	3.28	0.21
Kansas State Law Enforcement Training Center	Reno	KS	39	1	25.64	0.20
Wisconsin Dept of Justice - Criminal Investigation Div.	Dane	WI	92	1	10.87	0.20
Dayton International Airport Police Dept	Montgomery	OH	29	1	34.48	0.19
Delaware River Port Authority - Transit Police	Camden	NJ	144	1	6.94	0.19
Maryland Natural Resources Police	Anne Arundel	MD	224	1	4.46	0.19

Ohio Department of Taxation - Enforcement Division	Franklin	OH	30	1	33.33	0.18
San Antonio Park Rangers	Bexar	TX	112	3	26.79	0.17
District of Columbia Protective Services Police	District of Columbia	DC	484	1	2.07	0.17
University of Colorado - Colorado Springs Police Dept.	El Paso	CO	14	1	71.43	0.16
Maryland Department of General Services Police	Baltimore City	MD	68	1	14.71	0.16
Vanderbilt University Police Department	Davidson	TN	91	1	10.99	0.16
Maryland Transit Administration Police	Baltimore City	MD	140	1	7.14	0.16
Baltimore City School Police Dept.	Baltimore City	MD	142	1	7.04	0.16
Maryland Transportation Authority Police	Baltimore	MD	456	1	2.19	0.16
Port Authority of New York & New Jersey Police Dept	Hudson	NJ	1667	1	0.60	0.16
University of North Texas Police Department	Denton	TX	40	1	25.00	0.15
University of Alabama - Birmingham Police Dept	Jefferson	AL	79	1	12.66	0.15
College of Lake County Police Dept	Lake	IL	13	1	76.92	0.14
Boston School Police	Suffolk	MA	80	1	12.50	0.14
McAllen I.S.D. Police Dept.	Hidalgo	TX	43	1	23.26	0.13
New York State Metro Transportation Auth. Police	New York	NY	694	2	2.88	0.13
Ventura College	Ventura	CA	5	1	200.00	0.12
Bowie State University Dept. of Public Safety	Prince Georges	MD	14	1	71.43	0.12
Socorro I.S.D. Police Dept.	El Paso	TX	30	1	33.33	0.12
Northside I.S.D. Police Dept.	Bexar	TX	83	2	24.10	0.12
Middlesex County Prosecutor's Office	Middlesex	NJ	80	1	12.50	0.12
Buffalo State College Police	Erie	NY	30	1	33.33	0.11
Georgia State University Police	Fulton	GA	68	1	14.71	0.11
Indiana State Excise Police	Marion	IN	88	1	11.36	0.11
New Jersey Department of Environmental Protection	Burlington	NJ	90	1	11.11	0.11
St. Edward's University Police Department	Travis	TX	14	1	71.43	0.10
University of Texas - Austin Police	Travis	TX	62	1	16.13	0.10
Austin I.S.D. Police Department	Travis	TX	70	1	14.29	0.10
Texas Alcoholic Beverage Commission	Travis	TX	277	1	3.61	0.10
California Dept. of Justice	Sacramento	CA	419	1	2.39	0.10
Ohio State University Police Department	Franklin	OH	51	1	19.61	0.09
George Mason University Police Dept.	Fairfax	VA	52	1	19.23	0.09
Metropolitan Washington Airports Authority Police	Arlington	VA	206	1	4.85	0.09
Florida Atlantic University Police	Palm Beach	FL	39	1	25.64	0.08
Allegheny Port Authority Transit Police	Allegheny	PA	42	1	23.81	0.08
University of Pittsburgh - Main Campus Police	Allegheny	PA	73	1	13.70	0.08

California Exposition And State Fair Police	Sacramento	CA	6	1	166.67	0.07
Santa Ana Unified School District Police Dept.	Orange	CA	21	2	95.24	0.07
MIT Police Department	Middlesex	MA	59	1	16.95	0.07
BART Police Department	Alameda	CA	192	1	5.21	0.07
School District of Philadelphia Police	Philadelphia	PA	450	1	2.22	0.07
St. Mary's University Police Department	Bexar	TX	20	1	50.00	0.06
Wayne State University Dept of Public Safety	Wayne	MI	49	1	20.41	0.05
Lancaster I.S.D. Police Dept.	Dallas	TX	6	1	166.67	0.04
Florida International University Police	Miami-Dade	FL	39	1	25.64	0.04
Dallas I.S.D. Police Dept.	Dallas	TX	88	1	11.36	0.04
North Forest I.S.D. Police Dept.	Harris	TX	21	1	47.62	0.02
Humble I.S.D. Police Dept.	Harris	TX	24	1	41.67	0.02
Houston Baptist University Police Department	Harris	TX	30	1	33.33	0.02
California Bureau of Narcotics Enforcement	Sacramento	CA	73	2	27.40	0.02
Houston Community College System	Harris	TX	48	1	20.83	0.02
Los Angeles School Police Department	Los Angeles	CA	340	2	5.88	0.02
University of California - Los Angeles Police	Los Angeles	CA	57	1	17.54	0.01

Appendix D: State and Local Law Enforcement Agencies: Police Crime Arrest Cases (N = 6,724)

Agency	City	County	State	Agency ID	Arrest Cases
Abbeville Police Department	Abbeville	Henry	AL	13947490	2
Aberdeen Police Department	Aberdeen	Brown	OH	12664570	4
Acadia Parish Sheriff's Office	Crowley	Acadia	LA	12018700	1
Accomack County Sheriff's Office	Accomac	Accomack	VA	12188710	1
Acworth Police Department	Acworth	Cobb	GA	13069400	1
Ada Police Department	Ada	Pontotoc	OK	11665940	1
Adams County Sheriff's Office	Brighton	Adams	CO	11549150	2
Akron Police Department	Akron	Summit	OH	12234580	8
Alabama Department of Public Safety	Montgomery	Montgomery	AL	13191010	2
Alachua County Sheriff's Office	Gainesville	Alachua	FL	11719100	1
Alameda County Sheriff's Office	Oakland	Alameda	CA	11629140	4
Alameda Police Department	Alameda	Alameda	CA	11098570	2
Alamo Police Department	Alamo	Hidalgo	TX	12526390	1
Alamogordo Department of Public Safety	Alamogordo	Otero	NM	11264980	1
Alaska State Troopers	Anchorage	Anchorage	AK	11914750	1
Albany Police Department	Albany	Albany	NY	12534810	9
Albany Police Department	Albany	Linn	OR	12855640	1
Albany Police Department	Albany	Dougherty	GA	13969090	4
Albert Lea Police Department	Albert Lea	Freeborn	MN	12432730	1
Albuquerque Police Department	Albuquerque	Bernalillo	NM	11464990	13
Alcester Police Department	Alcester	Union	SD	12676620	1
Alexander Police Department	Alexander	Pulaski	AR	13081100	1
Alexandria Police	Alexandria	Madison	IN	12070640	1
Alexandria Police Department	Alexandria	Alexandria City	VA	13414740	3
Algonquin Police Dept	Algonquin	McHenry	IL	13153610	1
Algood Police Department	Algood	Putnam	TN	13922190	1
Alhambra Police Department	Alhambra	Los Angeles	CA	13518750	2
Alice Police Department	Alice	Jim Wells	TX	12306300	1
Allegan County Sheriff's Office	Allegan	Allegan	MI	12098750	3
Allegheny County Police Department.	Pittsburgh	Allegheny	PA	11975540	2
Allegheny County Sheriff's Office	Pittsburgh	Allegheny	PA	11689110	3
Allegheny Port Authority Transit Police	Pittsburgh	Allegheny	PA	11277060	1

Allen Police Department	Allen	Collin	TX	12636310	2
Allendale Police Department	Allendale	Allendale	SC	12876730	2
Allenstown Police Department	Allenstown	Merrimack	NH	12633470	1
Allentown Police Department	Allentown	Lehigh	PA	11635550	3
Alma Police Department	Alma	Bacon	GA	13337130	1
Alorton Police Dept	Alorton	St. Clair	IL	13041000	3
Altamonte Springs Police Department	Altamonte Springs	Seminole	FL	13960890	1
Alton Police Department	Alton	Hidalgo	TX	11804130	2
Alton Police Dept	Alton	Madison	IL	13716370	1
Altoona Police Department	Altoona	Blair	PA	11455590	4
Amber Police Department	Amber	Grady	OK	11575920	1
Amboy/Vernon Center Police Department	Amboy	Blue Earth	MN	12332720	1
Amite Police Department	Amite	Tangipahoa	LA	12741840	2
Anaheim Police Department	Anaheim	Orange	CA	11402520	7
Anchorage International Airport Police	Anchorage	Anchorage	AK	13995990	1
Anchorage Police Department	Anchorage	Anchorage	AK	13579150	11
Andalusia Police Dept.	Andalusia	Covington	AL	13400140	1
Anderson County Sheriff's Office	Anderson	Anderson	SC	11149160	3
Anderson Police	Anderson	Madison	IN	12460620	7
Anderson Police Department	Anderson	Anderson	SC	12126790	3
Anderson Police Department	Anderson	Shasta	CA	13061700	1
Andrews Police Department	Andrews	Georgetown	SC	12266720	1
Ann Arbor Police Department	Ann Arbor	Washtenaw	MI	12921160	4
Anne Arundel County Police Department	Millersville	Anne Arundel	MD	12291250	3
Annville Township Police Department	Annville	Lebanon	PA	11865590	1
Anoka County Sheriff's Office	Anoka	Anoka	MN	11039180	1
Ansonia Police Department	Ansonia	New Haven	CT	13023000	3
Apopka Police Department	Apopka	Orange	FL	13453640	3
Appalachian State University Police Dept	Boone	Watauga	NC	13369530	1
Appling County Sheriff's Office	Baxley	Appling	GA	12568680	1
Aquia Harbour Police Department	Stafford	Stafford	VA	99900022	1
Arapahoe County Sheriff's Office	Centennial	Arapahoe	CO	11409140	2
Arcade Police Department	Jefferson	Jackson	GA	13013000	1
Arizona Department of Public Safety	Phoenix	Maricopa	AZ	13129410	3
Arkansas Highway Police	Little Rock	Pulaski	AR	13540550	2
Arkansas State Police	Little Rock	Pulaski	AR	13279920	2

Arkansas State University Police Dept.	State University	Craighead	AR	13047000	1
Arlington County Police Department	Arlington	Arlington	VA	11947620	1
Arlington Police Department	Arlington	Tarrant	TX	12226340	6
Arlington Police Department	Arlington	Middlesex	MA	12891500	1
Ashland Police Department	Ashland	Boone	MO	12022580	1
Aspen Police Department	Aspen	Pitkin	CO	13336630	2
Assumption Parish Sheriff's Office	Napoleonville	Assumption	LA	12178640	3
Athena Police Department	Athena	Umatilla	OR	12715660	1
Athens Police Department	Athens	Limestone	AL	11834090	1
Athens-Clarke County Police Dept	Athens	Clarke	GA	13318230	2
Atlanta Police Department	Atlanta	Fulton	GA	11961870	22
Atlantic Beach Police Department	Atlantic Beach	Horry	SC	12006770	2
Atlantic County Sheriff's Office	Mays Landing	Atlantic	NJ	12848680	1
Atwater Police Department	Atwater	Kandiyohi	MN	12792770	1
Aubrey Police Department	Aubrey	Denton	TX	12016380	1
Auburn Police Department	Auburn	Cayuga	NY	12184810	1
Auburn Police Department	Auburn	Androscoggin	ME	12911270	1
Auburndale Police Department	Auburndale	Polk	FL	11112240	1
Aurora Police	Aurora	Dearborn	IN	12420680	4
Aurora Police Department	Aurora	Portage	OH	12024500	2
Aurora Police Department	Aurora	Marion	OR	12795670	1
Aurora Police Department	Aurora	Arapahoe	CO	13444440	7
Austin I.S.D. Police Department	Austin	Travis	TX	13474440	1
Austin Police Department	Austin	Mower	MN	12142790	1
Austin Police Department	Austin	Travis	TX	12356380	11
Avalon Borough Police Department	Pittsburgh	Allegheny	PA	11415550	1
Avoca Borough Police	Avoca	Luzerne	PA	11025540	2
Avon Park Police Department	Avon Park	Highlands	FL	11677630	6
Avon Police Department	Avon	Hartford	CT	13874780	1
Ayden Police Department	Ayden	Pitt	NC	12453850	1
Aztec Police Department	Aztec	San Juan	NM	13647160	1
Babbitt Police Department	Babbitt	St. Louis	MN	12602740	1
Bainbridge Police Department	Bainbridge	Decatur	GA	11580490	2
Baker County Sheriff's Office	Newton	Baker	GA	12418660	1
Bakersfield Police Department	Bakersfield	Kern	CA	13959390	11
Bal Harbour Village Police Department	Bal Harbour	Miami-Dade	FL	13851380	1

Bally Borough Police Department	Bally	Berks	PA	11835590	1
Baltimore (City) Sheriff's Office	Baltimore	Baltimore City	MD	12428670	2
Baltimore City School Police Dept.	Baltimore	Baltimore City	MD	13048100	1
Baltimore County Police Department	Towson	Baltimore	MD	12941270	4
Baltimore County Sheriff's Office	Towson	Baltimore	MD	12278650	1
Baltimore Police Department	Baltimore	Baltimore City	MD	12651260	62
Bangor Police Department	Bangor	Penobscot	ME	12331200	1
Barnegat Township Police	Barnegat	Ocean	NJ	12553360	1
Barnstable County Sheriff's Office	Bourne	Barnstable	MA	11898670	5
Barnstable Police Department	Hyannis	Barnstable	MA	12881580	4
Barre Police Department	Barre	Worcester	MA	12281580	2
Barre Police Department	Barre	Washington	VT	12607470	1
Barrow County Sheriff's Office	Winder	Barrow	GA	12569110	1
Barstow Police Department	Barstow	San Bernardino	CA	13495440	2
BART Police Department	Oakland	Alameda	CA	13581450	1
Bartlesville Police Department	Bartlesville	Washington	OK	11525930	4
Bartlett Police Department	Bartlett	Shelby	TN	13677160	1
Bartow Police Department	Bartow	Polk	FL	13103010	1
Baton Rouge Police Department	Baton Rouge	East Baton Rouge	LA	11021750	7
Battlefield Police Department	Battlefield	Greene	MO	12142510	1
Baxter County Sheriff's Office	Mountain Home	Baxter	AR	11928670	1
Bay County Sheriff's Office	Panama City	Bay	FL	12679190	3
Bay Village Police Department	Bay Village	Cuyahoga	OH	12874500	1
Bayou La Batre Police Department	Bayou La Batre	Mobile	AL	13335630	1
Baytown Police Department	Baytown	Harris	TX	12496390	1
Beardstown Police Dept	Beardstown	Cass	IL	13213020	3
Beaufort County Sheriff's Office	Beaufort	Beaufort	SC	12469140	1
Beaumont I.S.D. Police Dept.	Beaumont	Jefferson	TX	13348930	1
Beaumont Police Department	Beaumont	Jefferson	TX	12436390	2
Beaumont Police Department	Beaumont	Riverside	CA	13768970	1
Beaverton Police Department	Beaverton	Washington	OR	13343230	1
Bedford County Sheriff's Office	Bedford	Bedford	VA	11508690	2
Bedford Police Department	Bedford	Hillsborough	NH	12923420	1
Beeville Police Department	Beeville	Bee	TX	12486380	1
Belchertown Police Department	Belchertown	Hampshire	MA	12131550	1
Belen Police Department	Belen	Valencia	NM	13171710	1

Belgium Police Dept	Westville	Vermilion	IL	13316430	7
Bell Police Department	Bell	Los Angeles	CA	13682260	11
Bella Vista Police Department	Bella Vista	Benton	AR	13321230	1
Bellaire Police Department	Bellaire	Harris	TX	12406330	1
Belle Plaine Police Department	Belle Plaine	Scott	MN	12632740	1
Belle Police Department	Belle	Kanawha	WV	12028990	2
Belle Police Department	Belle	Maries	MO	12782580	1
Belleville Police Dept	Belleville	St. Clair	IL	13282220	1
Bellevue Police Dept	Bellevue	Sarpy	NE	11553550	2
Bellville Police Department	Bellville	Richland	OH	12014520	1
Bellwood Police Dept	Bellwood	Cook	IL	13007900	1
Beloit Police Department	Beloit	Rock	WI	12717210	1
Belpre Police Department	Belpre	Washington	OH	12274590	1
Bend Police Department	Bend	Deschutes	OR	12505670	2
Bennettsville Police Department	Bennettsville	Marlboro	SC	12506760	6
Bensalem Township Police Department	Bensalem	Bucks	PA	12145590	1
Benton County Sheriff's Office	Bentonville	Benton	AR	12908650	1
Benton Harbor Police Department	Benton Harbor	Berrien	MI	12241080	4
Benton Police Department	Benton	Saline	AR	13276920	1
Benzie County Sheriff's Office	Beulah	Benzie	MI	12288690	1
Berea Police Department	Berea	Madison	KY	12200010	1
Berkeley Police Department	Berkeley	St. Louis	MO	12532520	1
Berkeley Police Department	Berkeley	Alameda	CA	13410240	1
Berlin Borough Police Department	Berlin	Somerset	PA	12725510	1
Berlin Heights Police Department	Berlin Heights	Erie	OH	12524560	1
Berlin Police Department	Berlin	Worcester	MA	12671560	1
Berlin Police Department	Kensington	Hartford	CT	13126410	2
Bernalillo County Sheriff's Office	Albuquerque	Bernalillo	NM	12059140	3
Bernalillo Police Department	Bernalillo	Sandoval	NM	13777370	1
Bernville Borough Police Department	Bernville	Berks	PA	12775590	1
Berryville Police Department	Berryville	Clarke	VA	11867600	1
Berwyn Police Dept	Berwyn	Cook	IL	13438140	3
Bethany Beach Police Department	Bethany Beach	Sussex	DE	13241520	1
Bethel Police Department	Bethel	Fairfield	CT	13269120	3
Bethlehem Police Department	Bethlehem	Northampton	PA	12735580	4
Bethlehem Township Police Department	Bethlehem	Northampton	PA	12735520	1

Beverly Police Department	Beverly	Essex	MA	12731560	1
Bexar County Sheriff's Office	San Antonio	Bexar	TX	12619130	5
Bibb County Sheriff's Office	Macon	Bibb	GA	12049190	3
Bibb County Sheriff's Office	Centreville	Bibb	AL	12538660	1
Big Horn County Sheriff's Office	Hardin	Big Horn	MT	12778610	4
Big Sandy Police Department	Big Sandy	Upshur	TX	12656360	1
Big Spring Police Department	Big Springs	Howard	TX	12776350	1
Billings Police Department	Billings	Yellowstone	MT	12293970	2
Biloxi Police Department	Biloxi	Harrison	MS	12662130	2
Bingen-White Salmon Police Department	White Salmon	Klickitat	WA	13076800	1
Binghamton Police Department	Binghamton	Broome	NY	13285220	1
Birch Run Police Department	Birch Run	Saginaw	MI	12651050	3
Birchwood Police Department	Birchwood	Washburn	WI	12847220	1
Birmingham Police Department	Birmingham	Jefferson	AL	13738970	8
Bishopville Police Department	Bishopville	Lee	SC	12276730	1
Bismarck Police Department	Bismarck	St. Francois	MO	12052450	1
Black Mountain Police Department	Black Mountain	Buncombe	NC	12663810	1
Black River Falls Police Department	Black River Falls	Jackson	WI	12687270	1
Blackford County Sheriff's Office	Hartford City	Blackford	IN	12818650	1
Blacksburg Police Department	Blacksburg	Montgomery	VA	11547660	1
Blakely Borough Police Department	Peckville	Lackawanna	PA	12525590	1
Bloomer Police Department	Bloomer	Chippewa	WI	12397240	1
Bloomington Police Department	Bloomington	Van Buren	MI	12181020	1
Bloomington Police Dept	Bloomington	McLean	IL	11780660	6
Bloomville Police Department	Bloomville	Seneca	OH	99900095	1
Blountstown Police Dept.	Blountstown	Calhoun	FL	13849980	2
Blue Ash Police Department	Blue Ash	Hamilton	OH	12794450	2
Blue Lake Police Department	Blue Lake	Humboldt	CA	99900024	7
Bluefield Police Department	Bluefield	Mercer	WV	12608910	1
Bogalusa Police Department	Bogalusa	Washington	LA	11031700	1
Boiling Spring Lakes Police Department	Southport	Brunswick	NC	12053890	1
Boise Police Department	Boise	Ada	ID	13545850	6
Bolingbrook Police Dept	Bolingbrook	Will	IL	13303430	4
Bolivar County Sheriff's Office	Cleveland	Bolivar	MS	12688650	1
Bolivar Police Department	Bolivar	Hardeman	TN	12196590	1
Boone County Sheriff's Office	Burlington	Boone	KY	12769120	1

Boone Police Department	Boone	Watauga	NC	12643880	1
Boonsboro Police Department	Boonsboro	Washington	MD	12471270	1
Boonville Police Department	Boonville	Yadkin	NC	12693840	1
Bosque Farms Police Department	Peralta	Valencia	NM	13556950	2
Bossier City Police Dept	Bossier City	Bossier	LA	11281730	3
Bossier Parish Sheriff's Office	Benton	Bossier	LA	12329120	3
Boston Police Department	Boston	Suffolk	MA	12031520	17
Boston School Police	Boston	Suffolk	MA	11990083	1
Boswell Police Department	Boswell	Choctaw	OK	12295980	1
Boulder County Sheriff's Office	Boulder	Boulder	CO	12799150	1
Boulder Police Department	Boulder	Boulder	CO	13654860	1
Bowie State University Dept. of Public Safety	Bowie	Prince Georges	MD	13888480	1
Bowman Police Department	Bowman	Orangeburg	SC	13492840	10
Boyce Police Department	Boyce	Rapides	LA	11431750	1
Boynton Beach Police Department	Boynton Beach	Palm Beach	FL	13589350	8
Braceville Police Department	Newton Falls	Trumbull	OH	12984420	1
Bracken County Sheriff's Office	Brooksville	Bracken	KY	11388510	1
Braddock Borough Police Department	Braddock	Allegheny	PA	12645530	1
Bradley Police Dept	Bradley	Kankakee	IL	13127310	1
Brady Township Police Department	Oakley	Saginaw	MI	99900015	1
Braintree Police Department	Braintree	Norfolk	MA	12141530	1
Braselton Police Department	Braselton	Jackson	GA	13118410	2
Brazil Police	Brazil	Clay	IN	11080650	1
Brazoria County Sheriff's Office	Angleton	Brazoria	TX	12809160	1
Brentwood Police Department	Brentwood	Rockingham	NH	13173510	1
Brentwood Police Department	Brentwood	Prince George's	MD	99900101	1
Brevard County Sheriff's Office	Titusville	Brevard	FL	12209190	2
Brewster Police Department	Brewster	Barnstable	MA	12591540	3
Brick Township Police	Brick	Ocean	NJ	12283200	1
Bridgeport Police Department	Bridgeport	Belmont	OH	12364460	1
Bridgeport Police Department	Bridgeport	Jackson	AL	13492440	1
Bridgeport Police Department	Bridgeport	Fairfield	CT	13975390	4
Bridgeton Police	Bridgeton	Cumberland	NJ	12473230	3
Brigantine Police	Brigantine	Atlantic	NJ	12063200	1
Brighton Police Department	Brighton	Jefferson	AL	13306130	1
Bristol Borough Police Department	Bristol	Bucks	PA	12715500	1

Bristol Police Department	Bristol	Bristol City	VA	11007620	1
Bristol Police Department	Bristol	Hartford	CT	13466940	1
Brockton Police Department	Brockton	Plymouth	MA	12461510	4
Broken Arrow Police Department	Broken Arrow	Tulsa	OK	12685960	2
Brookfield Police Department	Brookfield	Waukesha	WI	12687210	1
Brookline Police Department	Brookline	Norfolk	MA	12941540	3
Brookneal Police Department	Brookneal	Campbell	VA	11377680	1
Brookshire Police Department	Brookshire	Waller	TX	12666250	1
Brooksville Police Department	Brooksville	Hernando	FL	13046300	1
Broomfield Police Department	Broomfield	Broomfield	CO	11464710	1
Broussard Police Department	Broussard	Lafayette	LA	11571770	1
Broward County Sheriff's Office	Fort Lauderdale	Broward	FL	12709120	22
Brownstown Police Department	Brownstown	Wayne	MI	12351000	1
Brownsville Police Department	Brownsville	Cameron	TX	12586230	1
Brownwood Police Department	Brownwood	Brown	TX	13866580	3
Brunswick County Sheriff's Office	Bolivia	Brunswick	NC	12439110	2
Brunswick Police Department	Brunswick	Frederick	MD	12971210	1
Bucks County Sheriff's Office	Doylestown	Bucks	PA	11758500	2
Buena Vista Township Police Department	Saginaw	Saginaw	MI	12101040	2
Buffalo Police Department	Buffalo	Erie	NY	12134820	9
Buffalo State College Police	Buffalo	Erie	NY	11322170	1
Bullard Police Department	Bullard	Smith	TX	13157710	1
Bullitt County Sheriff's Office	Shepherdsville	Bullitt	KY	12599170	1
Bunkie Police Department	Bunkie	Avoyelles	LA	11591760	1
Burgettstown Borough Police Department	Burgettstown	Washington	PA	12195550	1
Burke County Sheriff's Office	Morganton	Burke	NC	13074100	1
Burleigh County Sheriff's Office	Bismarck	Burleigh	ND	13991390	2
Burlington Police Department	Burlington	Alamance	NC	12843860	3
Burnham Police Department	Burnham	Cook	IL	13235220	1
Burns Police Department	Burns	Dickson	TN	12276510	1
Burr Oak Police Department	Burr Oak	St. Joseph	MI	12531060	2
Butler County Sheriff's Office	Greenville	Butler	AL	12878530	3
Butler Township Police Department	Dayton	Montgomery	OH	12724480	1
Butler Township Police Department	Ashland	Schuylkill	PA	12805590	1
Butte - Silver Bow County Sheriff's Office	Butte	Silver Bow	MT	12208580	2
Butte County Sheriff's Office	Oroville	Butte	CA	12779160	1

Byron Police Dept	Byron	Ogle	IL	13506950	1
BYU-Idaho Police Department	Rexburg	Madison	ID	99900010	1
Caddo Police Department	Caddo	Bryan	OK	12225940	1
Calcasieu Parish Sheriff's Office	Lake Charles	Calcasieu	LA	12609150	1
Caldwell Police Department	Caldwell	Canyon	ID	13307830	1
Caledonia Police Department	Caledonia	Racine	WI	11767260	1
Calhoun County Sheriff's Office	Blountstown	Calhoun	FL	13965890	1
Calhoun Police Department	Calhoun	Gordon	GA	11639970	1
California Bureau of Narcotics Enforcement	Sacramento	Sacramento	CA	99900008	3
California Dept. of Justice	Sacramento	Sacramento	CA	13106110	1
California Exposition And State Fair Police	Sacramento	Sacramento	CA	13907090	1
California Highway Patrol	Sacramento	Sacramento	CA	13998690	19
Calumet City Police Dept	Calumet City	Cook	IL	13710870	1
Calumet Park Police Dept	Calumet Park	Cook	IL	13280820	1
Calvert Police Department	Calvert	Robertson	TX	12976240	1
Cambridge Police Department	Cambridge	Middlesex	MA	12111510	1
Camden Police	Camden	Camden	NJ	12033290	15
Camden Police Department	Camden	Kershaw	SC	12706740	3
Cameron County Constable Pct. 1	Port Isabel	Cameron	TX	13852280	1
Cameron County Constable Pct. 4	Rio Hondo	Cameron	TX	13545050	1
Cameron County District Attorney Investigations Div	Brownville	Cameron	TX	99900100	1
Cameron County Sheriff's Office	Olmito	Cameron	TX	12598530	2
Campbell County Sheriff's Office	Gillette	Campbell	WY	12008510	1
Canton Police Department	Canton	Lincoln	SD	12386620	1
Canton Police Department	Canton	Stark	OH	12684470	2
Canton Police Department	Canton	Hartford	CT	13510050	1
Canton Police Dept	Canton	Fulton	IL	13758570	1
Canton Village Police Department	Canton	St. Lawrence	NY	12734850	1
Cape Coral Police Department	Cape Coral	Lee	FL	13198210	2
Cape Girardeau Police Department	Cape Girardeau	Cape Girardeau	MO	12752430	1
Carbondale Police Dept	Carbondale	Jackson	IL	13309030	1
Caribou Police Department	Caribou	Aroostook	ME	11331110	1
Carlisle Police Department	Carlisle	Nicholas	KY	12790030	1
Carlisle Police Department	Carlisle	Warren	IA	13262620	1
Carmel Police	Carmel	Hamilton	IN	11060600	3
Caroline County Sheriff's Office	Bowling Green	Caroline	VA	12188590	4

Carter County Sheriff's Office	Van Buren	Carter	MO	12538560	4
Caruthersville Police Department	Caruthersville	Pemiscot	MO	12842420	2
Carver County Sheriff's Office	Chaska	Carver	MN	12198570	1
Caryville Police Department	Caryville	Campbell	TN	12196560	1
Casselberry Police Department	Casselberry	Seminole	FL	13822380	2
Catawba County Sheriff's Office	Newton	Catawba	NC	12359030	1
Cathedral City Police Department	Cathedral City	Riverside	CA	13790770	3
Cedar Rapids Police Department	Cedar Rapids	Linn	IA	13500750	2
Centerville Police Department	Centerville	Davis	UT	12487780	2
Central Michigan University Police Department	Mount Pleasant	Isabella	MI	13108110	1
Central Point Police Department	Central Point	Jackson	OR	12045680	1
Centre County Sheriff's Office	Bellefonte	Centre	PA	12758530	1
Centreville Police Dept	Centreville	St. Clair	IL	13894180	2
Chaffee Police Department	Chaffee	Scott	MO	12822440	1
Chalfont Borough Police Department	Chalfont	Bucks	PA	12305560	1
Chambers County Sheriff's Office	Anahuac	Chambers	TX	12818590	1
Chambersburg Borough Police Department	Chambersburg	Franklin	PA	12035430	1
Chamblee Police Department	Chamblee	DeKalb	GA	13208920	2
Champaign Police Dept	Champaign	Champaign	IL	13095600	1
Chandler Police Department	Chandler	Henderson	TX	12496270	1
Chandler Police Department	Chandler	Lincoln	OK	12805990	2
Chandler Police Department	Chandler	Maricopa	AZ	13198410	2
Channahon Police Dept	Channahon	Will	IL	13671460	1
Charlack Police Department	Charlack	St. Louis	MO	12832480	1
Charleston County Sheriff's Office	Charleston	Charleston	SC	12389000	7
Charleston Police Department	Charleston	Kanawha	WV	12628960	10
Charleston Police Department	Charleston	Charleston	SC	12666770	2
Charlotte - Mecklenburg Police Department	Charlotte	Mecklenburg	NC	12483880	27
Charlotte County Sheriff's Office	Punta Gorda	Charlotte	FL	12829030	3
Charlottesville Police Dept.	Charlottesville	Charlottesville City	VA	11937610	1
Chattahoochee Police Department	Chattahoochee	Gadsden	FL	13616960	1
Chattanooga Police Department	Chattanooga	Hamilton	TN	12556570	15
Chelsea Police Department	Chelsea	Suffolk	MA	12391530	1
Chelsea Police Department	Chelsea	Rogers	OK	13409240	1
Cherokee County Sheriff's Office	Gaffney	Cherokee	SC	12668410	2
Cherokee Police Department	Cherokee	Alfalfa	OK	13349530	1

Cherry Hill Police	Cherry Hill	Camden	NJ	12773210	2
Chesapeake (City) Sheriff's Office	Chesapeake	Chesapeake City	VA	12428400	4
Chesapeake Police Department	Chesapeake	Chesapeake City	VA	11707600	3
Cheshire Police Department	Cheshire	New Haven	CT	13937190	2
Chester Township Police Department	Chester	Delaware	PA	12285480	1
Chesterfield County Police Department	Chesterfield	Chesterfield	VA	12497610	1
Chesterfield County Sheriff's Office	Chesterfield	Chesterfield	VA	12268420	1
Chesterfield County Sheriff's Office	Chesterfield	Chesterfield	SC	12718400	1
Chicago Police Dept	Chicago	Cook	IL	13642360	106
Chickasaw Police Department	Chickasaw	Mobile	AL	13594350	1
Chickasha Police Department	Chickasha	Grady	OK	13512350	1
Chico Police Department	Chico	Butte	CA	13771570	2
Chicopee Police Department	Chicopee	Hampden	MA	12211540	1
Chilhowie Police Department	Chilhowie	Smyth	VA	12347650	5
Chillicothe Police Department	Chillicothe	Livingston	MO	12872420	1
Chillicothe Police Department	Chillicothe	Ross	OH	13977890	1
Chillicothe Police Dept	Chillicothe	Peoria	IL	13372330	2
Chippewa Township Police Department	Beaver Falls	Beaver	PA	12735490	1
Chula Vista Police Department	Chula Vista	San Diego	CA	13051200	1
Cicero Police Dept	Cicero	Cook	IL	13022800	9
Cicero Town Police Department	Cicero	Onondaga	NY	13143610	1
Cincinnati Police Department	Cincinnati	Hamilton	OH	11320790	12
Circleville Police Department	Circleville	Pickaway	OH	13484840	1
Citrus Heights Police Department	Citrus Heights	Sacramento	CA	13172110	1
Clackamas County Sheriff's Office	Oregon City	Clackamas	OR	12229030	4
Clairton City Police Department	Clairton	Allegheny	PA	12255460	1
Clanton Police Department	Clanton	Chilton	AL	13683260	1
Clarendon Hills Police Dept	Clarendon Hills	Du Page	IL	13786670	1
Clark County Sheriff's Office	Jeffersonville	Clark	IN	12069090	1
Clark County Sheriff's Office	Springfield	Clark	OH	12969040	1
Clarke County Sheriff's Office	Berryville	Clarke	VA	11558400	1
Clarksdale Police Department	Clarksdale	Coahoma	MS	12992140	1
Clarksville Police	Clarksville	Clark	IN	12310690	3
Clarksville Police Department	Clarksville	Montgomery	TN	12456500	6
Clatskanie Police Department	Clatskanie	Columbia	OR	12845600	1
Clay County Sheriff's Office	Brazil	Clay	IN	11628470	1

Clay County Sheriff's Office	Piggott	Clay	AR	11928450	1
Clay County Sheriff's Office	Green Cove Springs	Clay	FL	12819080	3
Clay County Sheriff's Office	Liberty	Clay	MO	12869070	1
Clayton County Police Department	Jonesboro	Clayton	GA	11930160	3
Clayton County Sheriff's Office	St. Olaf	Clayton	IA	11878470	1
Clayton Police	Clayton	Gloucester	NJ	12363270	2
Clearlake Police Department	Clearlake	Lake	CA	11620500	1
Clearwater Police Department	Clearwater	Pinellas	FL	13170810	1
Cleveland County Sheriff's Office	Norman	Cleveland	OK	11928420	1
Cleveland Police Department	Cleveland	Cuyahoga	OH	11784440	27
Cleveland Police Department	Cleveland	Bradley	TN	12936540	7
Clewiston Police Department	Clewiston	Hendry	FL	13324630	2
Cliffside Park Police	Cliffside Park	Bergen	NJ	12823290	2
Clifton Police	Clifton	Passaic	NJ	12733200	1
Clinton Department of Public Safety	Clinton	Laurens	SC	12396720	1
Clinton Police	Clinton	Vermillion	IN	12700640	1
Clinton Police	Clinton	Hunterdon	NJ	12793290	1
Clinton Police Department	Clinton	Anderson	TN	12026550	3
Clinton Police Dept	Clinton	De Witt	IL	13413440	1
Clinton Township Police	Annandale	Hunterdon	NJ	12413230	5
Clovis Police Department	Clovis	Curry	NM	13935390	3
Clyde Police Department	Clyde	Sandusky	OH	11954450	1
Coal Valley Police Dept	Coal Valley	Rock Island	IL	13920690	1
Coatesville Police Department	Coatesville	Chester	PA	12995410	1
Cobb County Police Department	Marietta	Cobb	GA	13703970	5
Cobb County Sheriff's Office	Marietta	Cobb	GA	12088430	1
Cochran Police Department	Cochran	Bleckley	GA	13996890	3
Cockrell Hill Police Department	Dallas	Dallas	TX	13200020	1
Cocoa Beach Police Department	Cocoa Beach	Brevard	FL	13759070	1
Cocoa Police Department	Cocoa	Brevard	FL	13215120	2
Coconut Creek Police Department	Coconut Creek	Broward	FL	13061300	5
Coeburn Police Department	Coeburn	Wise	VA	12697680	1
Colebrookdale District Police	Boyertown	Berks	PA	13275520	1
Colfax Police Department	Colfax	Grant	LA	11991750	1
College of Lake County Police Dept	Grayslake	Lake	IL	13626960	1
College Park Police Department	College Park	Fulton	GA	13676560	1

Collier County Sheriff's Office	Naples	Collier	FL	12819050	8
Collin County Constable Pct. 4	Frisco	Collin	TX	13747370	1
Collingswood Police	Collingswood	Camden	NJ	12093230	1
Colonial Regional Police Department	Bethlehem	Northampton	PA	12275470	1
Colonie Town Police Department	Latham	Albany	NY	13675260	2
Colorado Springs Police Department	Colorado Springs	El Paso	CO	13976090	27
Colorado State Patrol	Lakewood	Jefferson	CO	13399230	4
Columbia County Sheriff's Office	Saint Helens	Columbia	OR	12248440	1
Columbia County Sheriff's Office	Appling	Columbia	GA	12289050	2
Columbia Police Department	Columbia	Richland	SC	12376730	9
Columbia Police Department	Columbia	Boone	MO	13706270	1
Columbiana County Sheriff's Office	Lisbon	Columbiana	OH	11808340	2
Columbiana Police Department	Columbiana	Shelby	AL	13665160	1
Columbus Police	Columbus	Bartholomew	IN	12400690	2
Columbus Police Department	Columbus	Franklin	OH	11554400	10
Columbus Police Department	Columbus	Polk	NC	11583850	2
Columbus Police Department	Columbus	Colorado	TX	11763350	1
Columbus Police Department	Columbus	Luna	NM	11854970	1
Columbus Police Department	Columbus	Lowndes	MS	12682150	1
Columbus Police Department	Columbus	Muscogee	GA	13439540	7
Commerce Police Department	Commerce	Ottawa	OK	12965960	1
Commerce Police Department	Commerce	Jackson	GA	13513850	1
Concord Police Department	Concord	Cabarrus	NC	11743850	1
Concord Police Department	Concord	Merrimack	NH	11843400	4
Concord Police Department	Concord	Contra Costa	CA	13071400	1
Connally I.S.D. Police Dept.	Waco	McLennan	TX	13529050	4
Conneaut Police Department	Conneaut	Ashtabula	OH	11794450	1
Connecticut State Police	Middletown	Middlesex	CT	13660860	5
Conroe Police Department	Conroe	Montgomery	TX	11776260	2
Conshohocken Borough Police Department	Conshohocken	Montgomery	PA	12135400	1
Contra Costa County Sheriff's Office	Martinez	Contra Costa	CA	12109030	1
Conway Police Department	Conway	Horry	SC	12616720	1
Conway Springs Police Department	Conway Springs	Sumner	KS	11150200	1
Conyers Police Department	Conyers	Rockdale	GA	13897980	1
Cook County Sheriff's Office	Chicago	Cook	IL	12639000	9
Cookeville Police Department	Cookeville	Putnam	TN	12416560	2

Coon Rapids Police Department	Coon Rapids	Anoka	MN	12792740	2
Coopersburg Borough Police Department	Coopersburg	Lehigh	PA	12575490	1
Cooter Police Department	Cooter	Pemiscot	MO	11722460	1
Coral Gables Police Department	Coral Gables	Miami-Dade	FL	13040600	2
Coraopolis Borough Police Department	Coraopolis	Allegheny	PA	12075400	1
Corbin Police Department	Corbin	Whitley	KY	11451990	1
Cordova Police Dept	Cordova	Rock Island	IL	11792220	1
Corinth Police Department	Corinth	Alcorn	MS	12632100	9
Corpus Christi Police Department	Corpus Christi	Nueces	TX	11956220	4
Cortland Police Department	Cortland	Cortland	NY	11314810	1
Costa Mesa Police Department	Costa Mesa	Orange	CA	13771170	1
Cottage Grove Police Department	Cottage Grove	Washington	MN	12812700	1
Council Bluffs Police Department	Council Bluffs	Pottawattomie	IA	13179710	1
Coventry Police Department	Coventry	Kent	RI	11066710	1
Covington Police Department	Covington	Kenton	KY	11021910	1
Covington Police Department	Covington	St. Tammany	LA	12581750	2
Covington Police Department	Covington	Newton	GA	13424940	1
Coweta County Sheriff's Office	Newnan	Coweta	GA	11269070	1
Coweta Police Department	Coweta	Wagoner	OK	12115990	1
Cowpens Police Department	Cowpens	Spartanburg	SC	12926740	1
Crafton Borough Police Department	Pittsburgh	Allegheny	PA	11845420	1
Craig Police Department	Craig	Moffat	CO	13641360	1
Cranberry Township Police Department	Cranberry Twp	Butler	PA	11245480	1
Cranford Police	Cranford	Union	NJ	12793200	1
Cranston Police Department	Cranston	Providence	RI	11236780	3
Crawford County Sheriff's Office	Van Buren	Crawford	AR	13660660	1
Crescent City Police Department	Crescent City	Putnam	FL	13526050	2
Crescent Police Department	Crescent	Logan	OK	12105980	1
Creston Police Department	Creston	Union	IA	13888580	2
Crestview Police Department	Crestview	Okaloosa	FL	13504350	1
Crookston Police Department	Crookston	Polk	MN	12702720	1
Cross County Sheriff's Office	Wynne	Cross	AR	11388360	1
Crossett Police Department	Crossett	Ashley	AR	13662860	1
Crowley Police Department	Crowley	Acadia	LA	12091700	1
Crystal City Police Department	Crystal City	Zavala	TX	12156270	5
Cullman County Sheriff's Office	Cullman	Cullman	AL	12288380	1

Cumberland Police Department	Cumberland	Allegany	MD	12081260	1
Custer County Sheriff's Office	Arapaho	Custer	OK	12188320	1
Cuyahoga County Sheriff's Office	Cleveland	Cuyahoga	OH	11939040	5
Cuyahoga Falls Police Department	Cuyahoga Falls	Summit	OH	12284450	5
Dade County Sheriff's Office	Trenton	Dade	GA	12388300	1
Dakota County Sheriff's Office	Hastings	Dakota	MN	12438350	1
Dale County Sheriff's Office	Ozark	Dale	AL	12448320	1
Dallas County Constable Pct. 5	Dallas	Dallas	TX	13131610	2
Dallas County Sheriff's Office	Dallas	Dallas	TX	11059080	1
Dallas County Sheriff's Office	Adel	Dallas	IA	11289090	2
Dallas I.S.D. Police Dept.	Dallas	Dallas	TX	13471340	1
Dallas Police Department	Dallas	Dallas	TX	12236230	47
Dallas Police Department	Dallas	Polk	OR	12395680	1
Dallas Township Police Department	Dallas	Luzerne	PA	11555470	1
Daly City Police Department	Daly City	San Mateo	CA	13849180	1
Damascus Police Department	Damascus	Washington	VA	12647690	3
Danbury Police Department	Danbury	Fairfield	CT	13900890	2
Dane County Sheriff's Office	Madison	Dane	WI	11749010	2
Danvers Police Department	Danvers	Essex	MA	12641530	1
Danville (City) Sheriff's Office	Danville	Danville City	VA	12898300	3
Danville Police	Danville	Hendricks	IN	11410540	1
Danville Police Department	Danville	Pittsylvania	VA	12477680	1
Danville Police Department	Danville	Contra Costa	CA	99900021	1
Danville Police Dept	Danville	Vermilion	IL	11207050	1
Darby Township Police Department	Sharon Hill	Delaware	PA	11625450	4
Darlington County Sheriff's Office	Darlington	Darlington	SC	12658370	1
Darlington Police Department	Darlington	Darlington	SC	12926710	3
Dauphin County Sheriff's Office	Harrisburg	Dauphin	PA	12758350	4
Davie County Sheriff's Office	Mocksville	Davie	NC	12568380	4
Davie Police Department	Davie	Broward	FL	13017300	2
Daviess County Sheriff's Office	Washington	Daviess	IN	12328390	1
Dayton International Airport Police Dept	Vandalia	Montgomery	OH	13227820	2
Dayton Police Department	Dayton	Montgomery	OH	12664420	2
Daytona Beach Police Department	Daytona Beach	Volusia	FL	13039000	6
Dearborn County Sheriff's Office	Lawrenceburg	Dearborn	IN	13508950	2
Dearborn Police Department	Dearborn	Wayne	MI	11911030	4

Decatur Police Department	Decatur	Morgan	AL	11816360	1
Decatur Police Dept	Decatur	Macon	IL	13779370	1
Dedham Police Department	Dedham	Norfolk	MA	12431510	1
Defuniak Springs Police Department	Defuniak Springs	Walton	FL	13080300	1
DeKalb County Police Department	Tucker	DeKalb	GA	13691660	18
DeKalb County Sheriff's Office	Decatur	DeKalb	GA	11709030	2
DeKalb County Sheriff's Office	Fort Payne	DeKalb	AL	12798390	1
DeKalb Police Dept	DeKalb	DeKalb	IL	13942390	1
Del Norte County Sheriff's Office	Crescent City	Del Norte	CA	12618370	3
Del Rio Police Department	Del Rio	Val Verde	TX	12346210	1
Delavan Police Department	Delavan	Walworth	WI	12737200	1
Delaware County Sheriff's Office	Media	Delaware	PA	12618340	4
Delaware County Sheriff's Office	Delaware	Delaware	OH	12648300	1
Delaware River & Bay Authority Police	New Castle	New Castle	DE	13607560	1
Delaware River Port Authority - Transit Police	Camden	Camden	NJ	13387130	1
Delaware State Police	Dover	Kent	DE	13737770	3
Delcambre Police Department	Delcambre	Vermilion	LA	12141750	1
Delhi Police Department	Delhi	Richland	LA	12711780	1
Delhi Village Police Department	Delhi	Delaware	NY	11744860	1
Delray Beach Police Department	Delray Beach	Palm Beach	FL	13138010	1
Demopolis Police Department	Demopolis	Marengo	AL	11896750	1
Denham Springs Police Department	Denham Springs	Livingston	LA	12271720	1
Denton Police Department	Denton	Denton	TX	12866230	1
Denton Police Department	Denton	Caroline	MD	12951280	1
Denver County Sheriff's Office	Denver	Denver	CO	99900005	6
Denver Police Department	Denver	Denver	CO	13778270	19
Denville Police	Denville	Morris	NJ	12713210	2
Deptford Police	Deptford	Gloucester	NJ	13375330	5
Deridder Police Department	Deridder	Beauregard	LA	12131710	1
Des Moines Police Department	Des Moines	King	WA	11337490	1
Des Moines Police Department	Des Moines	Polk	IA	13226720	7
Des Plaines Police Dept	Des Plaines	Cook	IL	13738070	1
Desert Hot Springs Police Department	Desert Hot Springs	Riverside	CA	11732710	2
Detroit Police Department	Detroit	Wayne	MI	11561090	27
Dewitt County Sheriff's Office	Clinton	De Witt	IL	11309010	1
Dewitt Police Department	Dewitt	Clinton	IA	13964190	1

Dickson City Police Department	Dickson City	Lackawanna	PA	11845450	1
Dillon Police Department	Dillon	Dillon	SC	12636770	1
Dillon Police Department	Dillon	Summit	CO	13842680	1
District of Columbia Protective Srvs Police Dept	Washington	District of Columbia	DC	99900173	1
Dixon Police Department	Dixon	Pulaski	MO	11712450	2
Dobbs Ferry Village Police Department	Dobbs Ferry	Westchester	NY	11084830	1
Dodge City Police Department	Dodge City	Ford	KS	11810200	1
Dolgeville Village Police Department	Dolgeville	Herkimer	NY	11034880	1
Dolton Police Dept	Dolton	Cook	IL	13455740	4
Donna Police Department	Donna	Hidalgo	TX	12286220	1
Dora Police Department	Dora	Walker	AL	13239920	1
Doraville Police Department	Doraville	DeKalb	GA	13339830	1
Dothan Police Department	Dothan	Houston	AL	13153710	2
Dougherty County Police Dept.	Albany	Dougherty	GA	13005200	3
Douglas County Sheriff's Office	Minden	Douglas	NV	12228330	1
Dover Police Department	Dover	Kent	DE	13173910	2
Downers Grove Police Dept	Downers Grove	Du Page	IL	13971890	1
Draper Police Department	Draper	Salt Lake	UT	12247730	1
Dubuque Police Department	Dubuque	Dubuque	IA	13563550	3
Duke University Police Department	Durham	Durham	NC	99900102	1
Duluth Police Department	Duluth	Gwinnett	GA	13553350	4
Dunbar Police Department	Dunbar	Kanawha	WV	12078820	1
Dunn Police Department	Dunn	Harnett	NC	11833820	1
Dunnellon Police Department	Dunnellon	Marion	FL	11215750	1
Dupont Borough Police Department	Dupont	Luzerne	PA	12675430	2
Dupont Police Department	Dupont	Pierce	WA	11077450	1
Duquesne Police Department	Duquesne	Allegheny	PA	12895430	1
Durand Police Department	Durand	Shiawassee	MI	11781080	1
Durango Police Department	Durango	La Plata	CO	13991090	1
Durant Police Department	Durant	Bryan	OK	12755910	1
Durham Police Department	Durham	Durham	NC	11713890	10
Duval County Sheriff's Office	San Diego	Duval	TX	12248340	1
Duxbury Police Department	Duxbury	Plymouth	MA	12051540	1
Earlville Police Dept	Earlville	La Salle	IL	13541850	1
East Baton Rouge Parish Sheriff's Office	Baton Rouge	East Baton Rouge	LA	12459010	3
East Brewton Police Department	East Brewton	Escambia	AL	13777770	1

East Chicago Police	East Chicago	Lake	IN	11940510	2
East Cleveland Police Department	East Cleveland	Cuyahoga	OH	12904400	2
East Conemaugh Borough Police Department	Johnstown	Cambria	PA	12375450	1
East Deer Township Police Department	Creighton	Allegheny	PA	12655410	1
East Earl Township Police Department	East Earl	Lancaster	PA	12345480	1
East Greenwich Police	East Greenwich	Kent	RI	11306790	3
East Kingston Police Department	East Kingston	Rockingham	NH	11993450	1
East Orange Police	East Orange	Essex	NJ	13012400	3
East Point Police Department	East Point	Fulton	GA	13104110	2
East Providence Police Department	East Providence	Providence	RI	11886700	2
East Rochester Village Police Department	East Rochester	Monroe	NY	12744890	1
East Spencer Police Department	East Spencer	Rowan	NC	11543810	1
East St. Louis Police Dept	East St. Louis	St. Clair	IL	13458740	8
East Washington Borough Police Department	Washington	Washington	PA	12325490	1
East Wenatchee Police Department	East Wenatchee	Douglas	WA	11247430	1
East Windsor Police Department	East Windsor	Hartford	CT	13715570	3
Eastchester Town Police Department	Eastchester	Westchester	NY	12334830	1
Eastlake Police Department	Eastlake	Lake	OH	12354480	1
Eastman Police Department	Eastman	Dodge	GA	11223410	1
Easton Police Department	Easton	Northampton	PA	12875440	7
Eaton County Sheriff's Office	Charlotte	Eaton	MI	12638200	1
Eatonton Police Department	Eatonton	Putnam	GA	11523000	7
Eau Claire Police Department	Eau Claire	Eau Claire	WI	12427210	1
Edecouch Police Department	Edecouch	Hidalgo	TX	11176140	1
Eden Police Department	Eden	Rockingham	NC	11373890	1
Edenton Police Department	Edenton	Chowan	NC	11733840	3
Edgewood Borough Police Department	Pittsburgh	Allegheny	PA	11975330	1
Edinburg Police Department	Edinburg	Hidalgo	TX	11726150	6
Edison Police	Edison	Middlesex	NJ	13891180	7
Edmond Police Department	Edmond	Oklahoma	OK	12595970	2
Edwardsville Police Department	Edwardsville	Wyandotte	KS	11580280	4
Egg Harbor Township Police	Egg Harbor Township	Atlantic	NJ	11013910	2
El Cajon Police Department	El Cajon	San Diego	CA	13139610	8
El Mirage Police Department	El Mirage	Maricopa	AZ	13442140	1
El Paso County Sheriff's Office	El Paso	El Paso	TX	12149070	2
El Paso County Sheriff's Office	Colorado Springs	El Paso	CO	12709000	1

El Paso Police Department	El Paso	El Paso	TX	11246150	22
El Paso Police Dept	El Paso	Woodford	IL	13134710	1
Elgin Police Department	Elgin	Grant	ND	11453600	1
Elgin Police Dept	Elgin	Kane	IL	13578350	6
Eliot Police Department	Eliot	York	ME	11761160	1
Elizabeth Police	Elizabeth	Union	NJ	13154910	12
Elk Grove Police Department	Elk Grove	Sacramento	CA	13727570	1
Elkhart Police	Elkhart	Elkhart	IN	11110560	5
Elkin Police Department	Elkin	Surry	NC	11533860	1
Elko County Sheriff's Office	Elko	Elko	NV	13077500	1
Elm Springs Police Department	Elm Springs	Washington	AR	13702270	1
Elmore Police Department	Elmore	Ottawa	OH	12224450	2
Elmwood Place Police Department	Cincinnati	Hamilton	OH	12014430	1
Elsa Police Department	Elsa	Hidalgo	TX	11576130	2
Elwood Police	Elwood	Madison	IN	11770560	1
Ely Police Department	Ely	St. Louis	MN	12552660	1
Elyria Police Department	Elyria	Lorain	OH	12514460	2
Emery County Sheriff's Office	Castle Dale	Emery	UT	12118280	2
Emmet County Sheriff's Office	Petoskey	Emmet	MI	12858290	1
Emmett Police Department	Emmett	Gem	ID	13626260	2
Energy Police Dept	Energy	Williamson	IL	13057300	3
Enfield Police Department	Enfield	Hartford	CT	13084700	4
Ennis I.S.D. Police Department	Ennis	Ellis	TX	13599350	1
Ephrata Police Department	Ephrata	Grant	WA	11197440	1
Erie Police Department	Erie	Erie	PA	11135310	1
Erie Police Department	Erie	Weld	CO	13819380	1
Errol Police Department	Errol	Coos	NH	99900018	1
Escambia County Sheriff's Office	Pensacola	Escambia	FL	13408040	3
Essex Police Department	Essex Junction	Chittenden	VT	12157460	1
Estill County Sheriff's Office	Irvine	Estill	KY	11478260	1
Euclid Police Department	Euclid	Cuyahoga	OH	11194360	1
Eudora Police Department	Eudora	Douglas	KS	12750290	1
Eules Police Department	Eules	Tarrant	TX	11146110	1
Eunice Police Department	Eunice	St. Landry	LA	12371700	6
Eunice Police Department	Eunice	Lea	NM	12884930	1
Eureka Police Department	Eureka	Humboldt	CA	13093100	2

Evansville Police	Evansville	Vanderburgh	IN	11320520	4
Evansville Police Department	Evansville	Rock	WI	11187130	1
Everett Police Department	Everett	Snohomish	WA	11957410	1
Fair Bluff Police Department	Fair Bluff	Columbus	NC	11333850	1
Fair Grove Police Department	Fair Grove	Greene	MO	12672410	1
Fair Haven Police	Fair Haven	Monmouth	NJ	11183280	1
Fair Oaks Ranch Police Department	Fair Oaks Ranch	Bexar	TX	13168310	1
Fairchance Borough Police Department	Fairchance	Fayette	PA	13139210	1
Fairfax County Police Department	Fairfax	Fairfax	VA	12377650	7
Fairfax County Sheriff's Office	Fairfax	Fairfax	VA	13575050	3
Fairfax Police Department	Fairfax	Allendale	SC	12606710	1
Fairfield Township Police Department	Hamilton	Butler	OH	11104390	1
Fairland Police Department	Fairland	Ottawa	OK	12205900	2
Fairmont Police Department	Fairmont	Robeson	NC	11753890	1
Fairview Heights Police Dept	Fairview Heights	St. Clair	IL	13208520	1
Fairview Police Department	Fairview	Williamson	TN	12336420	1
Fall River Police Department	Fall River	Bristol	MA	12211480	1
Fallowfield Township Police Department	Charleroi	Washington	PA	11055350	3
Falls Township Police Department	Fairless Hills	Bucks	PA	11835310	4
Falmouth Police Department	Falmouth	Barnstable	MA	12151420	1
Far Hills Police	Far Hills	Somerset	NJ	11173210	1
Farmington Police Department	Farmington	Davis	UT	12017790	1
Farmington Police Department	Farmington	San Juan	NM	12284970	5
Farmville Police Department	Farmville	Prince Edward	VA	11457540	2
Fayette County Sheriff's Office	Washington Court House	Fayette	OH	12398210	3
Fayette Police Department	Fayette	Fayette	AL	11425280	1
Fayetteville Police Department	Fayetteville	Cumberland	NC	12993850	2
Fayetteville Police Department	Fayetteville	Washington	AR	13666860	2
Federal Heights Police Department	Federal Heights	Adams	CO	13443140	1
Federal Way Police Department	Federal Way	King	WA	11497430	1
Felicity Police Department	Felicity	Clermont	OH	11254300	1
Fernandina Beach Police Department	Fernandina Beach	Nassau	FL	13284820	2
Ferriday Police Department	Ferriday	Concordia	LA	12431720	1
Ferry County Sheriff's Office	Republic	Ferry	WA	12528250	1
Fitchburg Police Department	Fitchburg	Worcester	MA	12101430	1
Flagler Beach Police Department	Flagler Beach	Flagler	FL	13443840	5

Flagler County Sheriff's Office	Bunnell	Flagler	FL	13813880	2
Flagstaff Police Department	Flagstaff	Coconino	AZ	13606860	1
Flat Rock Police Department	Flat Rock	Wayne	MI	12821090	1
Flemingsburg Police Department	Flemingsburg	Fleming	KY	11181910	1
Flint Police Department	Flint	Genesee	MI	12601000	6
Floralia Police Department	Floralia	Covington	AL	13690660	1
Florence Police Department	Florence	Florence	SC	12626790	2
Florence Police Department	Florence	Lauderdale	AL	13181410	1
Florida Atlantic University Police	Boca Raton	Palm Beach	FL	11990103	1
Florida Fish and Wildlife Conservation Commission	Tallahassee	Leon	FL	11990019	4
Florida Highway Patrol	Tallahassee	Leon	FL	13311630	14
Florida International University Police	Miami	Miami-Dade	FL	11990070	1
Floyd County Police Department	Rome	Floyd	GA	13862480	1
Floyd County Sheriff's Office	Charles City	Floyd	IA	13118510	1
Foley Police Department	Foley	Baldwin	AL	13917390	1
Folsom Police Department	Folsom	Sacramento	CA	13995490	2
Fond Du Lac Police Department	Fond Du Lac	Fond du Lac	WI	11767110	1
Fordland Police Department	Fordland	Webster	MO	99900025	2
Forest Acres Police Department	Columbia	Richland	SC	12026790	1
Forest City Police Department	Forest City	Winnebago	IA	13575950	2
Forest Park Police Department	Forest Park	Hamilton	OH	11564350	2
Forest Park Police Department	Forest Park	Clayton	GA	13630260	1
Forest Park Police Dept	Forest Park	Cook	IL	13875380	1
Forks Police Department	Forks	Clallam	WA	11717400	1
Forks Township Police Department	Easton	Northampton	PA	12115350	2
Forsyth County Sheriff's Office	Winston Salem	Forsyth	NC	13256320	3
Forsyth County Sheriff's Office	Cumming	Forsyth	GA	13663260	7
Fort Collins Police Department	Fort Collins	Larimer	CO	13444840	3
Fort Deposit Police Department	Fort Deposit	Lowndes	AL	13438240	2
Fort Dodge Police Department	Fort Dodge	Webster	IA	13541450	1
Fort Gibson Police Department	Ft. Gibson	Muskogee	OK	12285820	1
Fort Lauderdale Police Department	Fort Lauderdale	Broward	FL	13299420	6
Fort Madison Police Department	Fort Madison	Lee	IA	13902890	1
Fort Meade Police Department	Fort Meade	Polk	FL	99900017	1
Fort Myers Police Department	Fort Myers	Lee	FL	13761270	4
Fort Oglethorpe Police Dept	Ft Oglethorpe	Catoosa	GA	13210520	1

Fort Payne Police Department	Fort Payne	DeKalb	AL	13050200	1
Fort Pierce Police Department	Fort Pierce	St. Lucie	FL	13330130	5
Fort Smith Police Department	Fort Smith	Sebastian	AR	13048200	3
Fort Valley Police Department	Fort Valley	Peach	GA	13486340	1
Fort Wayne Police	Fort Wayne	Allen	IN	12330500	4
Fort Worth Police Department	Fort Worth	Tarrant	TX	12086110	22
Foster Township Police Department	Bradford	McKean	PA	12915390	1
Framingham Police Department	Framingham	Middlesex	MA	12731460	1
Frankfort Police Department	Frankfort	Franklin	KY	11691940	1
Frankfort Town Police Department	Frankfort	Herkimer	NY	12864890	1
Frankfort Village Police Department	Frankfort	Herkimer	NY	12214810	1
Franklin Borough Police	Franklin	Sussex	NJ	11513230	1
Franklin County Sheriff's Office	Brookville	Franklin	IN	11348200	1
Franklin County Sheriff's Office	Rocky Mount	Franklin	VA	11478200	2
Franklin County Sheriff's Office	Columbus	Franklin	OH	13260720	2
Franklin Police Department	Franklin	Milwaukee	WI	11027160	1
Franklin Police Dept	Franklin	Franklin	NE	12183500	2
Frederick County Sheriff's Office	Frederick	Frederick	MD	13762070	1
Frederick Police Department	Frederick	Frederick	MD	12341210	1
Freedom Police Department	Freedom	Carroll	NH	11863420	1
Freedom Township Police Department	Freedom	Outagamie	WI	11787130	1
Freehold Township Police	Freehold	Monmouth	NJ	11953260	1
Freeland Borough Police Department	Freeland	Luzerne	PA	12535300	2
Freemansburg Borough Police Department	Bethlehem	Northampton	PA	12775320	1
Fremont County Sheriff's Office	Sidney	Fremont	IA	13467940	1
Fremont Police Department	Fremont	Alameda	CA	11638020	1
Frenchtown Borough Police	Frenchtown	Hunterdon	NJ	11163290	1
Fresno County Sheriff's Office	Fresno	Fresno	CA	13219820	1
Fresno Police Department	Fresno	Fresno	CA	13715970	7
Frisco Police Department	Frisco	Summit	CO	13216520	1
Fruitland Police Department	Fruitland	Wicomico	MD	12491290	1
Fryeburg Police Department	Fryeburg	Oxford	ME	11211170	1
Fullerton Police Department	Fullerton	Orange	CA	11742600	3
Fulton County Police Department	Atlanta	Fulton	GA	13620360	2
Fulton County Sheriff's Office	Atlanta	Fulton	GA	11256130	5
Fulton Police Department	Fulton	Oswego	NY	11924730	1

Gaffney Police Department	Gaffney	Cherokee	SC	12986770	2
Gage County Sheriff's Office	Beatrice	Gage	NE	11278220	1
Gahanna Police Department	Gahanna	Franklin	OH	11394370	2
Gainesville Police Department	Gainesville	Alachua	FL	13057600	4
Galesburg Police Dept	Galesburg	Knox	IL	13022400	1
Gallatin County Sheriff's Office	Shawneetown	Gallatin	IL	11198270	2
Gallatin Police Department	Gallatin	Sumner	TN	12196400	3
Gallup Police Department	Gallup	McKinley	NM	12694960	1
Galt Police Department	Galt	Sacramento	CA	13204520	1
Galveston County Sheriff's Office	Galveston	Galveston	TX	13870980	1
Galveston Police Department	Galveston	Galveston	TX	12986130	2
Garden City Police Department	Garden City	Wayne	MI	12241020	1
Garden City Police Department	Garden City	Ada	ID	13073800	1
Garden Grove Police Department	Garden Grove	Orange	CA	13492340	3
Gardner Police Department	Gardner	Worcester	MA	12171440	1
Garfield Heights Police Dept.	Garfield Heights	Cuyahoga	OH	13931390	1
Garretson Police Department	Garretson	Minnehaha	SD	99900003	1
Gary Police	Gary	Lake	IN	12720570	12
Gaston County Police Department	Gastonia	Gaston	NC	12763810	2
Gastonia Police Department	Gastonia	Gaston	NC	12163810	2
Gatesville Police Department	Gatesville	Coryell	TX	12366170	1
Gatlinburg Police Department	Gatlinburg	Sevier	TN	12696460	2
Gautier Police Department	Gautier	Jackson	MS	12782030	1
Gaylord Police Department	Gaylord	Sibley	MN	13946190	1
Geneva Police Department	Geneva	Ontario	NY	11414720	1
Geneva Police Department	Geneva	Geneva	AL	13003600	1
Geneva Township Police Department	Lake Geneva	Walworth	WI	11067190	1
Gentry Police Department	Gentry	Benton	AR	13582050	1
George Mason University Police Dept.	Fairfax	Fairfax	VA	13851080	1
Georgetown County Sheriff's Office	Georgetown	Georgetown	SC	13263820	1
Georgetown Police Department	Georgetown	Sussex	DE	11959520	1
Georgetown Police Department	Georgetown	Williamson	TX	12696120	1
Georgia Department of Public Safety	Atlanta	Fulton	GA	13090900	2
Georgia Public Safety Training Center	Forsyth	Monroe	GA	99900175	2
Georgia State University Police	Atlanta	Fulton	GA	13131210	1
Gillette Police Department	Gillette	Campbell	WY	12968700	1

Glendale Heights Police	Glendale Heights	Du Page	IL	13273020	1
Glendale Police Department	Glendale	Los Angeles	CA	13195910	1
Glendive Police Department	Glendive	Dawson	MT	12253960	1
Glendora Police Department	Glendora	Los Angeles	CA	13469240	1
Glens Falls Police Department	Glens Falls	Warren	NY	11924790	1
Glenville Town Police Department	Glenville	Schenectady	NY	11954700	1
Gloucester Township Police	Blackwood	Camden	NJ	12563280	2
Goddard Police Department	Goddard	Sedgwick	KS	11150110	1
Gold Beach Police Department	Gold Beach	Curry	OR	11925640	1
Golden Beach Police Department	Golden Beach	Miami-Dade	FL	13741870	4
Golden Meadow Police Department	Golden Meadow	Lafourche	LA	12011710	1
Golden Valley Police Department	Golden Valley	Hennepin	MN	12172690	2
Goldsboro Police Department	Goldsboro	Wayne	NC	12723800	1
Goose Creek Police Department	Goose Creek	Berkeley	SC	12306750	1
Gordonsville Police Department	Gordonsville	Smith	TN	12136410	5
Graham County Sheriff's Office	Safford	Graham	AZ	11798110	1
Graham Police Department	Graham	Alamance	NC	12293880	1
Grambling State University Police Dept.	Grambling	Lincoln	LA	13540350	6
Granby Police Department	Granby	Hartford	CT	13293220	1
Grand Forks Police Department	Grand Forks	Grand Forks	ND	11073600	2
Grand Junction Police Department	Grand Junction	Mesa	CO	13097500	2
Grand Rapids Police Department	Grand Rapids	Kent	MI	11172940	1
Grand Rapids Police Department	Wisconsin Rapids	Wood	WI	11647110	1
Grand Traverse County Sheriff's Office	Traverse City	Grand Traverse	MI	11388110	4
Granite City Police Dept	Granite City	Madison	IL	13704970	1
Grant County Sheriff's Office	Medford	Grant	OK	11258140	1
Grant County Sheriff's Office	Marion	Grant	IN	11848190	1
Grant Park Police Dept	Grant Park	Kankakee	IL	13726670	1
Grants Police Department	Grants	Cibola	NM	12994980	1
Grapevine Police Department	Grapevine	Tarrant	TX	12066160	1
Grayslake Police Dept	Grayslake	Lake	IL	13171110	1
Great Bend Police Department	Great Bend	Barton	KS	11490100	1
Greece Town Police Department	Rochester	Monroe	NY	11984790	8
Greeley Police Department	Greeley	Weld	CO	13805680	2
Greenacres Department of Public Safety	Greenacres	Palm Beach	FL	13246420	1
Greenbrier County Sheriff's Office	Lewisburg	Greenbrier	WV	13567050	1

Greene County Sheriff's Office	Eutaw	Greene	AL	12018150	1
Greene County Sheriff's Office	Paragould	Greene	AR	12068110	1
Greenfield Police Department	Greenfield	Milwaukee	WI	12107110	1
Greensboro Police Department	Greensboro	Guilford	NC	12873800	6
Greensburg Police	Greensburg	Decatur	IN	12540550	1
Greenville County Sheriff's Office	Greenville	Greenville	SC	13412440	2
Greenville Police Department	Greenville	Greenville	SC	12486710	4
Greenville Police Department	Greenville	Washington	MS	12912060	3
Greenville Police Department	Greenville	Hunt	TX	12956160	1
Greenville Technical College Public Safety	Greenville	Greenville	SC	13683960	1
Greenwich Township Police	Gibbstown	Gloucester	NJ	12933240	1
Greenwood Police	Greenwood	Johnson	IN	12580590	1
Gregory Police Department	Gregory	San Patricio	TX	12286190	2
Gresham Police Department	Gresham	Multnomah	OR	13824980	1
Gretna Police Department	Gretna	Gadsden	FL	13412040	1
Griggs County Sheriff's Office	Cooperstown	Griggs	ND	13394530	1
Groton (Town) Police Department	Groton	New London	CT	13138210	1
Grove City Police Department	Grove City	Franklin	OH	12824390	1
Guadalupe County Sheriff's Office	Santa Rosa	Guadalupe	NM	12078150	1
Gulf Breeze Police Department	Gulf Breeze	Santa Rosa	FL	13077000	1
Gulfport Police Department	Gulfport	Harrison	MS	12652060	1
Gurnee Police Dept	Gurnee	Lake	IL	13426840	4
Guthrie Police Department	Guthrie	Logan	OK	12815840	1
Gwinnett County Police Department	Lawrenceville	Gwinnett	GA	13250220	4
Gwinnett County Sheriff's Office	Lawrenceville	Gwinnett	GA	13129110	5
Hackensack Police	Hackensack	Bergen	NJ	12763200	9
Hackettstown Police	Hackettstown	Warren	NJ	12003200	1
Hadley Police Department	Hadley	Hampshire	MA	12891400	1
Hagerstown Police Department	Hagerstown	Washington	MD	12031240	1
Haines City Police Department	Haines City	Polk	FL	13549750	2
Halifax County Sheriff's Office	Halifax	Halifax	VA	12308160	1
Hall County Sheriff's Office	Gainesville	Hall	GA	13746670	2
Hamburg Police Department	Hamburg	Fremont	IA	13367830	1
Hamden Police Department	Hamden	New Haven	CT	13090800	2
Hamilton County Sheriff's Office	Noblesville	Hamilton	IN	12748160	1
Hamilton County Sheriff's Office	Cincinnati	Hamilton	OH	13036900	1

Hamilton County Sheriff's Office	Chattanooga	Hamilton	TN	13482940	3
Hamilton Police Department	Hamilton	Butler	OH	12134330	1
Hammonton Police	Hammonton	Atlantic	NJ	12163260	1
Hampton County Sheriff's Office	Hampton	Hampton	SC	13979590	1
Hampton Police Department	Hampton	Hampton City	VA	11887530	2
Hamtramck Police Department	Hamtramck	Wayne	MI	11572900	2
Hanahan Police Department	Hanahan	Berkeley	SC	12186790	1
Hanceville Police Department	Hanceville	Cullman	AL	13265820	1
Hancock County Sheriff's Office	Greenfield	Hancock	IN	12108150	3
Hanging Rock Police Department	Hanging Rock	Lawrence	OH	12644310	3
Hannahville Tribal Police Department	Wilson	Menominee	MI	11732900	1
Hanover Police Department	Hanover	Plymouth	MA	12931440	1
Hanover Township Police Department	Burgettstown	Washington	PA	12035330	1
Harahan Police Department	Harahan	Jefferson	LA	12561760	1
Hardeeville Police Department	Hardeeville	Jasper	SC	12886740	2
Hardeman County Sheriff's Office	Bolivar	Hardeman	TN	12428150	1
Harford County Sheriff's Office	Bel Air	Harford	MD	13313030	1
Harker Heights Police Department	Harker Heights	Bell	TX	12926130	1
Harlingen Police Department	Harlingen	Cameron	TX	12056150	1
Harper Woods Police Department	Harper Woods	Wayne	MI	11482930	1
Harrah Police Department	Harrah	Oklahoma	OK	12925830	4
Harrington Police Department	Harrington	Kent	DE	13434640	2
Harris County Constable Pct. 4	Spring	Harris	TX	13752270	1
Harris County Constable Pct. 6	Houston	Harris	TX	13948690	1
Harris County Constable Pct. 7	Houston	Harris	TX	13469940	1
Harris County Sheriff's Office	Houston	Harris	TX	11414020	3
Harrisburg Police Department	Harrisburg	Dauphin	PA	12325310	1
Harrison County Sheriff's Office	Marshall	Harrison	TX	12438100	3
Harrison County Sheriff's Office	Gulfport	Harrison	MS	13190310	1
Harrison County Sheriff's Office	Corydon	Harrison	IN	13441440	1
Harrodsburg Police Department	Harrodsburg	Mercer	KY	12681960	1
Hartford Police Department	Hartford	Hartford	CT	13377230	12
Hartsville Police Department	Hartsville	Darlington	SC	12566790	2
Harvard Police Department	Harvard	Worcester	MA	12061460	1
Harvey Police Dept	Harvey	Cook	IL	13431340	7
Haskell Police Department	Haskell	Muskogee	OK	12735830	2

Haskell Police Department	Haskell	Haskell	TX	12926100	1
Hastings Police Department	Hastings	Dakota	MN	12392630	5
Hastings Police Dept	Hastings	Adams	NE	12473500	2
Hattiesburg Police Department	Hattiesburg	Forrest	MS	12402060	2
Haverhill Police Department	Haverhill	Essex	MA	12541460	1
Hawkins County Sheriff's Office	Rogersville	Hawkins	TN	12558190	1
Hawthorne Police Department	Hawthorne	Alachua	FL	13878680	1
Haynesville Police Dept	Haynesville	Claiborne	LA	12211750	1
Hayward Police Department	Hayward	Alameda	CA	13469640	2
Haywood County Sheriff's Office	Brownsville	Haywood	TN	13013500	1
Hegins Township Police Department	Valley View	Schuylkill	PA	12955370	1
Helen Police Department	Helen	White	GA	13714070	1
Helena/West Helena Police Department	West Helena	Phillips	AR	13099800	4
Hemingway Police Department	Hemingway	Williamsburg	SC	12106710	1
Hempstead County Sheriff's Office	Hope	Hempstead	AR	12838030	1
Hempstead Village Police Department	Hempstead	Nassau	NY	12214750	1
Henderson Police Department	Henderson	Clark	NV	12044920	2
Henderson Police Department	Henderson	Chester	TN	12646470	1
Hendry County Sheriff's Office	Labelle	Hendry	FL	13326130	1
Hennessey Police Department	Hennessey	Kingfisher	OK	12345850	1
Henrico County Division of Police	Henrico	Henrico	VA	11047570	4
Henry County Police Department	McDonough	Henry	GA	11644700	1
Henry County Sheriff's Office	Martinsville	Henry	VA	11797320	14
Henry County Sheriff's Office	Abbeville	Henry	AL	12828050	1
Hephzibah Police Department	Hephzibah	Richmond	GA	13729270	1
Herkimer Village Police Department	Herkimer	Herkimer	NY	12894730	1
Hermann Police Department	Hermann	Gasconade	MO	11631060	1
Hernando County Sheriff's Office	Brooksville	Hernando	FL	11528550	1
Herrin Police Dept	Herrin	Williamson	IL	13678460	1
Hialeah Gardens Police Department	Hialeah Gardens	Miami-Dade	FL	13425040	2
Hialeah Police Department	Hialeah	Miami-Dade	FL	13397130	1
Hickory Police Department	Hickory	Catawba	NC	12863880	1
Hidalgo County Sheriff's Office	Edinburg	Hidalgo	TX	13216720	7
Highlands County Sheriff's Office	Sebring	Highlands	FL	13898580	2
Hillsborough County Sheriff's Office	Tampa	Hillsborough	FL	13370130	10
Hillside Police	Hillside	Union	NJ	11093190	2

Hilltown Township Police Department	Hilltown	Bucks	PA	12175320	1
Hinesburg Police Department	Hinesburg	Chittenden	VT	12607410	1
Hingham Police Department	Hingham	Plymouth	MA	12931410	1
Hiram Police Department	Hiram	Portage	OH	12034390	1
Hitchcock Police Department	Hitchcock	Galveston	TX	12436060	1
Hoboken Police	Hoboken	Hudson	NJ	11133110	3
Hobson City Police Department	Hobson City	Calhoun	AL	99900013	1
Hockley County Sheriff's Office	Levelland	Hockley	TX	13467340	2
Hoke County Sheriff's Office	Raeford	Hoke	NC	13009500	1
Holden Beach Police Department	Holden Beach	Brunswick	NC	11703780	2
Holden Police Department	Holden	Worcester	MA	12251460	1
Holland Police Department	Holland	Ottawa	MI	11982960	1
Holland Police Department	Holland	Hampden	MA	99900026	1
Hollidaysburg Borough Police Department	Hollidaysburg	Blair	PA	12155300	1
Hollister Police Department	Hollister	San Benito	CA	11846670	1
Holly Hill Police Department	Holly Hill	Orangeburg	SC	12166620	4
Holly Springs Public Safety	Holly Springs	Wake	NC	11083730	1
Hollywood Police Department	Hollywood	Broward	FL	13845080	8
Holmes County Sheriff's Office	Holmesville	Holmes	OH	13380930	1
Holt County Sheriff's Office	Oneill	Holt	NE	12048060	1
Holyoke Police Department	Holyoke	Hampden	MA	12031460	1
Homer City Borough Police Department	Homer City	Indiana	PA	12455370	1
Homestead Police Department	Homestead	Miami-Dade	FL	13734570	3
Hondo Police Department	Hondo	Medina	TX	12286060	1
Honolulu (City and County) Police Department	Honolulu	Honolulu	HI	13346430	28
Hooksett Police Department	Hooksett	Merrimack	NH	12203480	1
Hope Mills Police Department	Hope Mills	Cumberland	NC	11713730	2
Hopkinsville Police Department	Hopkinsville	Christian	KY	12291950	1
Hornell Police Department	Hornell	Steuben	NY	12914720	1
Horry County Police Department	Conway	Horry	SC	12126640	9
Horry County Sheriff's Office	Conway	Horry	SC	12388080	1
Horsham Township Police Department	Horsham	Montgomery	PA	12335320	1
Houma Police Department	Houma	Terrebonne	LA	12741750	1
Houston Baptist University Police Department	Houston	Harris	TX	99900170	1
Houston Community College System	Houston	Harris	TX	13350930	1
Houston Police Department	Houston	Harris	TX	12476060	38

Howard County Police Department	Ellicott City	Howard	MD	11481280	3
Howard Lake Police Department	Howard Lake	Wright	MN	13334730	1
Howey-In-The-Hills Police Department	Howey-In-The-Hills	Lake	FL	13050400	1
Hudson County Sheriff's Office	Jersey City	Hudson	NJ	13316030	4
Hudson Police Department	Hudson	Hillsborough	NH	12013450	2
Hudson Police Department	Hudson	Summit	OH	12514390	3
Hudson Police Department	Hudson	Middlesex	MA	12951430	1
Humble I.S.D. Police Dept.	Humble	Harris	TX	13257420	1
Humboldt Police Department	Humboldt	Gibson	TN	13548750	2
Hunter Police Department	Tannersville	Greene	NY	12934710	1
Hunterdon County Sheriff's Office	Flemington	Hunterdon	NJ	13870380	1
Huntington Beach Police Department	Huntington Beach	Orange	CA	13297220	2
Huntington Park Police Department	Huntington Park	Los Angeles	CA	13612960	1
Huntsville Police Department	Huntsville	Madison	AL	13624860	3
Huron Police Department	Huron	Beadle	SD	11296530	1
Hurricane Police Department	Hurricane	Washington	UT	12237630	1
Hurricane Police Department	Hurricane	Putnam	WV	12348840	1
Hutto Police Department	Hutto	Williamson	TX	12006040	1
Hyattsville Police Department	Hyattsville	Prince Georges	MD	11701220	2
Iberia Parish Sheriff's Office	New Iberia	Iberia	LA	13432140	7
Idaho Falls Police Department	Idaho Falls	Bonneville	ID	13680760	1
Idaho State Police	Meridian	Ada	ID	13780170	1
Ilion Village Police Department	Ilion	Herkimer	NY	13963290	1
Illinois State Police	Springfield	Sangamon	IL	13900790	19
Independence Police Department	Independence	Jackson	MO	12232320	1
Independence Police Department	Independence	Tangipahoa	LA	12261710	1
Indian River County Sheriff's Office	Vero Beach	Indian River	FL	13852180	4
Indiana Borough Police Department	Indiana	Indiana	PA	12265250	1
Indiana State Excise Police	Indianapolis	Marion	IN	13869580	1
Indiana State Police	Indianapolis	Marion	IN	13119110	4
Indiana Township Police Dept.	Pittsburgh	Allegheny	PA	12305230	1
Indiana University Purdue University Fort Wayne University Police	Fort Wayne	Allen	IN	99900171	1
Indianapolis Police	Indianapolis	Marion	IN	12690540	43
Inglewood Police Department	Inglewood	Los Angeles	CA	13253920	4
Inkster Police Department	Inkster	Wayne	MI	12052910	2
Inman Police Department	Inman	McPherson	KS	12940140	4

Iowa City Police Department	Iowa City	Johnson	IA	13439940	1
Iowa Department of Public Safety	Des Moines	Polk	IA	13118710	2
Iowa Police Department	Iowa	Calcasieu	LA	12611770	1
Irondequoit Town Police Department	Rochester	Monroe	NY	13326830	2
Irvine Police Department	Irvine	Orange	CA	13657760	1
Irving Police Department	Irving	Dallas	TX	12806050	2
Irvington Police	Irvington	Essex	NJ	11193110	2
Ishpeming Police Department	Ishpeming	Marquette	MI	12132930	1
Isle of Wight County Sheriff's Office	Isle Of Wight	Isle of Wight	VA	11318020	1
Iva Police Department	Iva	Anderson	SC	12686600	1
Jackson County Sheriff's Office	Marianna	Jackson	FL	11688070	1
Jackson County Sheriff's Office	Holton	Jackson	KS	11908040	1
Jackson County Sheriff's Office	Gainesboro	Jackson	TN	13360030	11
Jackson Police Department	Jackson	Cape Girardeau	MO	12762350	3
Jackson Police Department	Jackson	Jackson	MI	12772940	1
Jackson Police Department	Jackson	Hinds	MS	12842030	9
Jackson Police Department	Jackson	Madison	TN	12926410	5
Jackson Police Department	Jackson	Butts	GA	13021700	1
Jackson Township Police Department	Massillon	Stark	OH	12194330	1
Jackson Township Police Department	Zelienople	Butler	PA	12525260	1
Jacksonville Beach Police Department	Jacksonville Beach	Duval	FL	13792170	1
Jacksonville Sheriff's Office	Jacksonville	Duval	FL	13517850	16
Jaffrey Police Department	Jaffrey	Cheshire	NH	12173490	1
James City County Police Dept.	Williamsburg	James City	VA	13559350	1
Jamestown Police Department	Jamestown	Chautauqua	NY	13871780	2
Jefferson City Police Department	Jefferson City	Cole	MO	12552390	1
Jefferson Parish Sheriff's Office	Harvey	Jefferson	LA	12338070	15
Jeffersontown Police Department	Jeffersontown	Jefferson	KY	12491990	1
Jennings Police Department	Jennings	Jefferson Davis	LA	12871720	1
Jersey City Police	Jersey City	Hudson	NJ	11123190	14
Jim Wells County Sheriff's Office	Alice	Jim Wells	TX	11093650	1
Johnson City Police Department	Johnson City	Washington	TN	12736410	1
Johnson City Village Police Department	Johnson City	Broome	NY	13893480	2
Johnston County Sheriff's Office	Smithfield	Johnston	NC	12678060	1
Johnston Police Department	Johnston	Providence	RI	13382830	1
Joliet Police Dept	Joliet	Will	IL	13216820	3

Joplin Police Department	Joplin	Jasper	MO	12402300	1
Juneau County Sheriff's Office	Mauston	Juneau	WI	13699460	1
Juneau Police Dept.	Juneau	Juneau	AK	13197410	1
Jupiter Police Department	Jupiter	Palm Beach	FL	13162610	1
Kahoka Police Department	Kahoka	Clark	MO	12092340	1
Kalamazoo Dept of Public Safety	Kalamazoo	Kalamazoo	MI	12842910	1
Kalispell Police Department	Kalispell	Flathead	MT	12903980	4
Kane County Sheriff's Office	Geneva	Kane	IL	13299320	1
Kansas City Police Department	Kansas City	Jackson	MO	12092370	5
Kansas City Police Department	Kansas City	Wyandotte	KS	12240100	11
Kansas State Law Enforcement Training Center	Hutchinson	Reno	KS	99900168	3
Kauai (County) Police Department	Lihue	Kauai	HI	13024300	3
Kaw Nation Tribal Police	Kaw City	Kay	OK	12165860	1
Kemp Police Department	Kemp	Kaufman	TX	11486010	1
Kendallville Police	Kendallville	Noble	IN	12020590	1
Kenly Police Department	Kenly	Johnston	NC	13493340	1
Kennebunk Police Department	Kennebunk	York	ME	11011190	1
Kennedale Police Department	Kennedale	Tarrant	TX	11506090	1
Kennedy Township Police Department	Coraopolis	Allegheny	PA	11835040	2
Kenner Police Department	Kenner	Jefferson	LA	12161640	1
Kennett Square Borough Police Department	Kennett Square	Chester	PA	13705470	4
Kennewick Police Department	Kennewick	Benton	WA	12257410	1
Kenosha County Sheriff's Office	Kenosha	Kenosha	WI	13800880	1
Kent County Sheriff's Office	Dover	Kent	DE	99900020	1
Kenton Police Department	Kenton	Obion	TN	12616440	1
Kentucky Alcoholic Beverage Control	Frankfort	Franklin	KY	13210820	3
Kentucky State Police	Frankfort	Franklin	KY	13988390	3
Keokuk County Sheriff's Office	Sigourney	Keokuk	IA	13889480	2
Kermit Police Department	Kermit	Winkler	TX	11736070	1
Kern County Sheriff's Office	Bakersfield	Kern	CA	13536350	16
Kerrville Police Department	Kerrville	Kerr	TX	11176050	1
Kershaw County Sheriff's Office	Lugoff	Kershaw	SC	11859940	1
Ketchikan Police Dept.	Ketchikan	Ketchikan Gateway	AK	13500450	1
Kildeer Police Dept	Lake Zurich	Lake	IL	13941790	1
Kilgore Police Department	Kilgore	Gregg	TX	11166070	1
Killeen Police Department	Killeen	Bell	TX	11616020	3

King City Police Department	King City	Washington	OR	11035610	1
King County Sheriff's Office	Seattle	King	WA	13531950	7
Kingfisher County Sheriff's Office	Kingfisher	Kingfisher	OK	11709950	1
Kingman Police Department	Kingman	Kingman	KS	12570120	1
Kings Mountain Police Department	Kings Mountain	Cleveland	NC	11263790	5
Kingsland Police Dept	Kingsland	Camden	GA	13778470	1
Kingsport Police Department	Kingsport	Sullivan	TN	12376490	3
Kingston Police Department	Kingston	Ulster	NY	12604790	1
Kingston Police Department	Kingston	Rockingham	NH	12713490	1
Kingston Police Department	Kingston	Plymouth	MA	12721480	1
Kingston Police Department	Kingston	Luzerne	PA	13112610	1
Kingsville Police Department	Kingsville	Kleberg	TX	11526020	1
Kissimmee Police Department	Kissimmee	Osceola	FL	13856580	3
Kitsap County Sheriff's Office	Port Orchard	Kitsap	WA	13560950	1
Kittery Police Department	Kittery	York	ME	12271170	1
Kitty Hawk Police Department	Kitty Hawk	Dare	NC	11943740	1
Klamath Falls Police Department	Klamath Falls	Klamath	OR	11985670	1
Knightdale Police Department	Knightdale	Wake	NC	11703720	1
Knox County Sheriff's Office	Knoxville	Knox	TN	13546150	1
Kokomo Police	Kokomo	Howard	IN	12840590	1
La Crosse County Sheriff's Office	La Crosse	La Crosse	WI	13920190	1
La Grange Park Police Dept	La Grange Park	Cook	IL	13739870	1
La Porte County Sheriff's Office	La Porte	La Porte	IN	11979970	2
La Salle County Sheriff's Office	Ottawa	La Salle	IL	11779990	1
La Salle County Sheriff's Office	Cotulla	La Salle	TX	12499960	8
Lafayette College Office of Public Safety	Easton	Northampton	PA	99900160	2
Lafayette Police	Lafayette	Tippecanoe	IN	12030450	1
Lafayette Police Department	Lafayette	Lafayette	LA	12741690	1
Lafayette Police Department	Lafayette	Walker	GA	13112910	2
Lafayette Police Department	Lafayette	Boulder	CO	13450540	2
Lafollette Police Department	Lafollette	Campbell	TN	12776420	3
Lafourche Parish Sheriff's Office	Thibodaux	Lafourche	LA	13787770	3
LaGrange Police Department	LaGrange	Troup	GA	13424540	1
Lake Angelus Police Department	Auburn Hills	Oakland	MI	12422990	1
Lake Charles Police Department	Lake Charles	Calcasieu	LA	12621660	2
Lake City Police Department	Lake City	Florence	SC	12806600	3

Lake County Sheriff's Office	Leadville	Lake	CO	12219900	21
Lake County Sheriff's Office	Tavares	Lake	FL	13264720	3
Lake County Sheriff's Office	Madison	Lake	SD	13454740	1
Lake County Sheriff's Office	Lakeport	Lake	CA	13583250	3
Lake County Sheriff's Office	Waukegan	Lake	IL	13749970	1
Lake County Sheriff's Office	Crown Point	Lake	IN	13951990	5
Lake Crystal Police Department	Lake Crystal	Blue Earth	MN	11472650	1
Lake Mary Police Department	Lake Mary	Seminole	FL	13713070	1
Lake St. Louis Police Department	Lake St Louis	St. Charles	MO	12972310	1
Lake Wales Police Department	Lake Wales	Polk	FL	13800180	6
Lakeland Police Department	Lakeland	Polk	FL	13478940	5
Lakeland Police Department	Lakeland	Lanier	GA	13942690	1
Lakeport Police Department	Lakeport	Lake	CA	13846280	1
Lakes Area Police Department	Lindstrom	Chisago	MN	11832690	1
Lakeville Police Department	Lakeville	Dakota	MN	11462670	2
Lakeway Police Department	Austin	Travis	TX	12536060	1
Lakewood Police Department	Lakewood	Pierce	WA	12837480	1
Lamesa Police Department	Lamesa	Dawson	TX	12116020	1
Lamoure Police Department	Lamoure	LaMoure	ND	12983630	1
Lancaster County Sheriff's Office	Lancaster	Lancaster	SC	12919970	1
Lancaster I.S.D. Police Dept.	Lancaster	Dallas	TX	13203720	1
Lancaster Police Department	Lancaster	Fairfield	OH	12214320	1
Lancaster Police Department	Lancaster	Garrard	KY	12271960	1
Lancaster Police Department	Lancaster	Lancaster	PA	12315270	2
Lancaster Town Police Department	Lancaster	Erie	NY	12294730	1
Lander University Public Safety	Greenwood	Greenwood	SC	13876980	1
Lansford Police Department	Lansford	Carbon	PA	12625230	2
Lansing Police Department	Lansing	Leavenworth	KS	12110100	1
Lansing Police Department	Lansing	Ingham	MI	12432910	5
Lantana Police Department	Lantana	Palm Beach	FL	13099100	1
Laredo Police Department	Laredo	Webb	TX	12026000	4
Largo Police Department	Largo	Pinellas	FL	11670000	1
Las Cruces Police Department	Las Cruces	Dona Ana	NM	12744950	1
Las Vegas Metro Police Department	Las Vegas	Clark	NV	12244990	9
Las Vegas Police Department	Las Vegas	San Miguel	NM	12194940	1
Lauderhill Police Department	Lauderhill	Broward	FL	13834980	1

Laurel Police Department	Laurel	Prince Georges	MD	11491200	2
Laurel Police Department	Laurel	Kent	DE	13043700	2
Laurens County Sheriff's Office	Laurens	Laurens	SC	12879990	4
Laurens Police Department	Laurens	Laurens	SC	12616630	1
Lavergne Police Department	Lavergne	Rutherford	TN	12896470	1
Lawrence County Sheriff's Office	Bedford	Lawrence	IN	12869950	2
Lawrence Police Department	Lawrence	Essex	MA	11391440	6
Lawrence Township Police	Lawrenceville	Mercer	NJ	11933150	1
Lawrence Township Police Department	Hyde	Clearfield	PA	13806580	1
Lawton Police Department	Lawton	Comanche	OK	13177110	1
Lebanon Junction Police Department	Lebanon Junction	Bullitt	KY	12631950	1
Lebanon Police	Lebanon	Boone	IN	12440420	2
Lebanon Police Department	Lebanon	Grafton	NH	11713310	1
Lebanon Police Department	Lebanon	Wilson	TN	12076410	1
Lebanon Police Department	Lebanon	Laclede	MO	12202320	1
Lebanon Police Department	Lebanon	Warren	OH	12484370	1
Lee County Sheriff's Office	Bishopville	Lee	SC	12669940	1
Lee County Sheriff's Office	Sanford	Lee	NC	12739920	1
Lee County Sheriff's Office	Fort Myers	Lee	FL	13183810	7
Leesville Police Department	Leesville	Vernon	LA	12031610	1
Leetsdale Borough Police Department	Leetsdale	Allegheny	PA	13101110	1
Lehigh-Northampton Airport Authority Police Dept	Allentown	Lehigh	PA	13376630	1
Leighton Police Department	Leighton	Colbert	AL	13830280	2
Leland Police Department	Leland	Washington	MS	12962020	1
Lemont Police Dept	Lemont	Cook	IL	11240930	1
Lenawee County Sheriff's Office	Adrian	Lenawee	MI	12529960	1
Lenoir County Sheriff's Office	Kinston	Lenoir	NC	11651510	2
Leominster Police Department	Leominster	Worcester	MA	11971450	1
Leon County Sheriff's Office	Tallahassee	Leon	FL	13042700	3
Level Plains Police Department	Daleville	Dale	AL	13006200	2
Lewis County Sheriff's Office	Monticello	Lewis	MO	12819960	1
Lexington Police Department	Lexington	Richland	OH	12094230	1
Lexington Police Department	Lexington	Lexington	SC	12926680	1
Liberty County Sheriff's Office	Liberty	Liberty	TX	13237420	2
Liberty Police Department	Liberty	Pickens	SC	12796680	1
Liberty Township Police Department	Youngstown	Trumbull	OH	12864210	1

Lima Police Department	Lima	Allen	OH	12944290	3
Lincoln County Sheriff's Office	Lincolnton	Lincoln	NC	12169980	4
Lincoln County Sheriff's Office	Newport	Lincoln	OR	12189930	1
Lincoln County Sheriff's Office	Lincolnton	Lincoln	GA	12339990	1
Lincoln County Sheriff's Office	Canton	Lincoln	SD	12969930	1
Lincoln Parish Sheriff's Office	Ruston	Lincoln	LA	12109980	1
Lincoln Police Department	Lincoln	Providence	RI	13881480	1
Lincoln Police Dept	Lincoln	Lancaster	NE	12563590	1
Lindale Police Department	Lindale	Smith	TX	12576010	1
Lisbon Police Department	Lisbon	Waukesha	WI	99900014	1
Litchfield Police Department	Litchfield	Hillsborough	NH	11093350	1
Little Egg Harbor Township Police	Little Egg Harbor	Ocean	NJ	12833150	1
Little River-Academy Police Department	Little River	Bell	TX	12606010	2
Little Rock Police Department	Little Rock	Pulaski	AR	13714970	3
Little Silver Police	Little Silver	Monmouth	NJ	11543140	1
Littleton Police Department	Littleton	Middlesex	MA	11291470	2
Livingston County Sheriff's Office	Howell	Livingston	MI	12149990	4
Livingston Parish Sheriff's Office	Livingston	Livingston	LA	13410040	1
Lockhart Police Department	Lockhart	Covington	AL	13102910	1
Lockport Police Department	Lockport	Niagara	NY	12964710	1
Lockport Police Dept	Lockport	Will	IL	13213820	1
Logan Township Police Department	Altoona	Blair	PA	11645220	2
Long Beach Police Department	Long Beach	Los Angeles	CA	11790270	6
Long County Sheriff's Office	Ludowici	Long	GA	12689900	1
Longboat Key Police Department	Longboat Key	Manatee	FL	13374930	1
Longmont Police Department	Longmont	Boulder	CO	13580750	1
Longwood Police Department	Longwood	Seminole	FL	13698660	3
Lorain Police Department	Lorain	Lorain	OH	12564230	5
Loris Police Department	Loris	Horry	SC	12566670	1
Los Angeles County Sheriff's Office	Monterey Park	Los Angeles	CA	13080500	17
Los Angeles Police Department	Los Angeles	Los Angeles	CA	13545150	33
Los Angeles School Police Department	Los Angeles	Los Angeles	CA	11331990	2
Los Lunas Police Department	Los Lunas	Valencia	NM	12434900	1
Loudon Police Department	Loudon	Loudon	TN	11896440	10
Loudoun County Sheriff's Office	Leesburg	Loudoun	VA	13200720	2
Louisiana State Police	Baton Rouge	East Baton Rouge	LA	13138310	2

Louisiana State University Health Sciences Center Police Dept	Shreveport	Caddo	LA	13587250	1
Louisiana State University Police Department	Baton Rouge	East Baton Rouge	LA	13300930	1
Louisville Metro Police Department	Louisville	Jefferson	KY	12561910	16
Loves Park Police Dept	Loves Park	Winnebago	IL	13086900	1
Lowell Police Department	Lowell	Middlesex	MA	11241450	5
Lowell Police Department	Lowell	Kent	MI	12182980	1
Lowell Police Department	Lowell	Benton	AR	13023400	1
Lower Paxton Township Police Department	Harrisburg	Dauphin	PA	11755270	1
Lower Township Police	Erma	Cape May	NJ	12453180	1
Lowndes County Sheriff's Office	Valdosta	Lowndes	GA	13008400	1
Lowndes County Sheriff's Office	Hayneville	Lowndes	AL	13460440	1
Lubbock County Constable Pct. 3	Lubbock	Lubbock	TX	13774370	2
Lubbock Police Department	Lubbock	Lubbock	TX	11907910	7
Lucas County Sheriff's Office	Toledo	Lucas	OH	13850380	4
Lumberton Police Department	Lumberton	Robeson	NC	12143730	1
Lumberton Township Police Department	Lumberton	Burlington	NJ	12573170	1
Luna County Sheriff's Office	Deming	Luna	NM	12759880	2
Luna Pier Police Department	Luna Pier	Monroe	MI	12412920	1
Luther Police Department	Luther	Oklahoma	OK	11945880	2
Luzerne County Sheriff's Office	Wilkes Barre	Luzerne	PA	12989820	2
Lykens Borough Police Department	Lykens	Dauphin	PA	12425280	1
Lyndhurst Police Department	Lyndhurst	Cuyahoga	OH	12754290	1
Lynn Police Department	Lynn	Essex	MA	11351430	2
Lynwood Police Dept	Lynwood	Cook	IL	11810960	3
Macomb County Sheriff's Office	Mount Clemens	Macomb	MI	13309530	1
Macon Police Department	Macon	Bibb	GA	13429340	12
Madbury Police Department	Madbury	Strafford	NH	99900023	1
Madera County Sheriff's Office	Madera	Madera	CA	13862980	1
Madill Police Department	Madill	Marshall	OK	11255850	1
Madison County Sheriff's Office	Huntsville	Madison	AL	13738470	1
Madison County Sheriff's Office	Fredericktown	Madison	MO	13870580	1
Madison County Sheriff's Office	Danielsville	Madison	GA	13983590	1
Madison Heights Police Department	Madison Heights	Oakland	MI	12682970	2
Madison Police Department	Madison	Dane	WI	12167140	1
Madison Police Department	Madison	Morris	NJ	12953170	1
Madison Police Department	Madison	Madison	AL	13913390	2

Madison Police Department	Madison	New Haven	CT	13966390	4
Mahanoy City Borough Police Department	Mahanoy City	Schuylkill	PA	12255240	1
Maine State Police	Augusta	Kennebec	ME	13505850	1
Malakoff Police Department	Malakoff	Henderson	TX	11697990	1
Malverne Village Police Department	Malverne	Nassau	NY	12504750	1
Manalapan Township Police	Manalapan	Monmouth	NJ	12193140	1
Manassas Park Police Dept.	Manassas Park	Manassas Park City	VA	12997510	1
Manatee County Sheriff's Office	Palmetto	Manatee	FL	13065500	4
Manchester Police Department	Manchester	Hillsborough	NH	11453390	1
Manchester Police Department	Manchester	Hartford	CT	13359630	2
Manhattan Beach Police Department	Manhattan Beach	Los Angeles	CA	13861280	1
Manheim Borough Police Department	Manheim	Lancaster	PA	12875260	1
Manheim Township Police Department	Lancaster	Lancaster	PA	12565210	1
Manitou Springs Police Department	Manitou Springs	El Paso	CO	13628160	1
Manitowoc Police Department	Manitowoc	Manitowoc	WI	12167110	2
Mansfield Police Department	Mansfield	Bristol	MA	11751480	2
Mansfield Police Department	Mansfield	De Soto	LA	12621600	1
Mantua Township Police	Mantua	Gloucester	NJ	12423180	1
Maple Shade Township Police	Maple Shade	Burlington	NJ	12433100	1
Maplewood Police Department	Maplewood	Ramsey	MN	11852620	1
Marana Police Department	Marana	Pima	AZ	11774920	1
Marathon County Sheriff's Office	Wausau	Marathon	WI	12949850	1
Marble Falls Police Department	Marble Falls	Burnet	TX	11237970	1
Marble Head Police Department	Marble Head	Ottawa	OH	12704270	1
Marco Island Police Department	Marco Island	Collier	FL	13482340	1
Marcus Hook Borough Police Department	Marcus Hook	Delaware	PA	12585260	1
Maricopa County Sheriff's Office	Phoenix	Maricopa	AZ	13195710	3
Maricopa Police Department	Maricopa	Kern	CA	99900097	3
Marietta Police Department	Marietta	Cobb	GA	13932890	1
Marin County Sheriff's Office	San Rafael	Marin	CA	13045300	1
Marion County Sheriff's Office	Indianapolis	Marion	IN	12429830	7
Marion County Sheriff's Office	Salem	Marion	OR	12719810	1
Marion County Sheriff's Office	Fairmont	Marion	WV	13139810	1
Marion County Sheriff's Office	Ocala	Marion	FL	13767470	3
Marion Police Department	Marion	Smyth	VA	12027520	1
Marion Police Department	Marion	Marion	SC	12756610	1

Marion Township Police Department	Wautoma	Waushara	WI	12717150	2
Marksville Police Department	Marksville	Avoyelles	LA	12711600	1
Marlboro County Sheriff's Office	Bennettsville	Marlboro	SC	11699880	2
Marlborough Township Police Department	Green Lane	Montgomery	PA	12725240	1
Marlow Police Department	Marlow	Stephens	OK	11055810	1
Marshallville Police Dept.	Marshallville	Macon	GA	13833980	2
Martin County Sheriff's Office	Williamston	Martin	NC	11789810	1
Martin County Sheriff's Office	Stuart	Martin	FL	13052400	1
Martins Ferry Police Department	Martins Ferry	Belmont	OH	12904280	2
Martinsburg Police Department	Martinsburg	Berkeley	WV	13971990	1
Martinsville Police	Martinsville	Morgan	IN	12400410	1
Marvell Police Department	Marvell	Phillips	AR	13969690	1
Maryland Department of General Services Police	Baltimore	Baltimore City	MD	13044300	2
Maryland National Capital Park Police - Montgomery County	Silver Spring	Montgomery	MD	13699060	1
Maryland Natural Resources Police	Annapolis	Anne Arundel	MD	13819680	1
Maryland State Police	Pikesville	Baltimore	MD	13301330	10
Maryland Transit Administration Police	Baltimore	Baltimore City	MD	13307730	1
Maryland Transportation Authority Police	Baltimore	Baltimore	MD	13021300	1
Marysville Borough Police Department	Marysville	Perry	PA	12545220	15
Marysville Police Department	Marysville	Yuba	CA	13697060	2
Mason City Police Department	Mason City	Cerro Gordo	IA	13915890	1
Mason County Sheriff's Office	Point Pleasant	Mason	WV	11139890	3
Mason Police Department	Mason	Warren	OH	12814290	1
Massachusetts Department of Mental Health Police Department	Boston	Suffolk	MA	99900174	2
Massachusetts State Police	Framingham	Middlesex	MA	13071700	12
Massillon Police Department	Massillon	Stark	OH	12464250	1
Mathis Police Department	Mathis	San Patricio	TX	11917950	1
Maui (County) Police Department	Wailuku	Maui	HI	13155310	5
Maywood Police Department	Maywood	Los Angeles	CA	13202220	4
Maywood Police Dept	Maywood	Cook	IL	12460990	3
MBTA Transit Police	Boston	Suffolk	MA	13962590	2
McAllen I.S.D. Police Dept.	McAllen	Hidalgo	TX	13955090	1
McAllen Police Department	McAllen	Hidalgo	TX	11644030	3
McArthur Police Department	McArthur	Vinton	OH	12184200	1
McCandless Township Police Department	Wexford	Allegheny	PA	11545190	1
McCullom Lake Police Dept	McHenry	McHenry	IL	12740950	1

McDonough Police Department	McDonough	Henry	GA	13960190	1
McDowell County Sheriff's Office	Welch	McDowell	WV	11159840	1
McDowell County Sheriff's Office	Marion	McDowell	NC	11809890	1
McHenry County Sheriff's Office	Woodstock	McHenry	IL	13395030	2
McIntosh County Sheriff's Office	Eufaula	McIntosh	OK	13280020	4
McKeesport Police Department	McKeesport	Allegheny	PA	11855150	2
McKinley County Sheriff's Office	Gallup	McKinley	NM	12999840	2
McMechen Police Department	McMechen	Marshall	WV	11990093	2
Medford Police Department	Medford	Middlesex	MA	11371450	1
Medford Police Department	Medford	Jackson	OR	11845660	2
Medical College of Georgia	Augusta	Richmond	GA	11314140	1
Medical Lake Police Department	Medical Lake	Spokane	WA	11957380	1
Medical University of South Carolina Public Safety	Charleston	Charleston	SC	13277220	1
Medina Police Department	Medina	Gibson	TN	11096460	1
Meigs Police Department	Meigs	Thomas	GA	13577450	1
Melbourne Beach Police Department	Melbourne Beach	Brevard	FL	13788570	2
Melbourne Police Department	Melbourne	Brevard	FL	13763970	1
Melrose Park Police Dept	Melrose Park	Cook	IL	13243420	5
Memphis Police Department	Memphis	Shelby	TN	11736410	64
Mendenhall Police Department	Mendenhall	Simpson	MS	13517350	3
Mentor Police Department	Mentor	Lake	OH	11714220	1
Merced Police Department	Merced	Merced	CA	13543750	2
Mercersburg Borough Police Department	Mercersburg	Franklin	PA	11565170	1
Meriden Police Department	Meriden	New Haven	CT	13820480	2
Meridian Police Department	Meridian	Lauderdale	MS	11202080	4
Merrillville Police	Merrillville	Lake	IN	12510460	2
Mesa Police Department	Mesa	Maricopa	AZ	13251620	5
Mesilla Marshal's Office	Mesilla	Dona Ana	NM	13260020	1
Mesquite Police Department	Mesquite	Dallas	TX	13572450	1
Metropolitan Washington Airports Authority Police	Arlington	Arlington	VA	13874080	1
Meyersdale Borough Police Department	Meyersdale	Somerset	PA	11785170	3
Miami Beach Police Department	Miami Beach	Miami-Dade	FL	13925190	4
Miami Police Department	Miami	Ottawa	OK	11015800	1
Miami Police Department	Miami	Miami-Dade	FL	13780370	16
Miami Township Police Department	Miamisburg	Montgomery	OH	11494220	1
Miami-Dade (County) Police Department	Miami	Miami-Dade	FL	13076900	26

Michigan City Police	Michigan City	La Porte	IN	12080440	1
Michigan State Police	East Lansing	Ingham	MI	13148110	9
Middle Township Police	Cape May Court House	Cape May	NJ	13324130	3
Middlesex County Prosecutor's Office	New Brunswick	Middlesex	NJ	13810580	3
Middlesex County Sheriff's Department	New Brunswick	Middlesex	NJ	11885390	4
Middlesex County Sheriff's Office	Saluda	Middlesex	VA	12439870	1
Middlesex Police Department	Middlesex	Nash	NC	12893750	1
Middletown Borough Police Department	Middletown	Dauphin	PA	11585160	2
Middletown Police	Middletown	Henry	IN	12150450	1
Middletown Police Department	Middletown	Butler	OH	11784260	1
Middletown Police Department	Middletown	Middlesex	CT	13508650	2
Midland Borough Police Department	Midland	Beaver	PA	11245110	2
Midland I.S.D. Police Dept.	Midland	Midland	TX	13550650	1
Midland Park Police	Midland Park	Bergen	NJ	12043150	1
Midland Police Department	Midland	Midland	TX	11877950	1
Midland Police Department	Midland	Midland	MI	12522910	1
Milford Police Department	Milford	New Haven	CT	13750470	2
Millbrook Police Department	Millbrook	Elmore	AL	13432440	1
Millcreek Township Police Department	Erie	Erie	PA	11205130	1
Miller County Sheriff's Office	Tuscumbia	Miller	MO	13334930	1
Millersburg Police Department	Millersburg	Holmes	OH	11794240	1
Millsboro Police Department	Millsboro	Sussex	DE	13212520	1
Milltown Police	Milltown	Middlesex	NJ	12293170	1
Millville Police	Millville	Cumberland	NJ	12323140	7
Milton Police Department	Milton	Santa Rosa	FL	13537250	2
Milwaukee County Sheriff's Office	Milwaukee	Milwaukee	WI	13102210	8
Milwaukee Police Department	Milwaukee	Milwaukee	WI	12207020	85
Minden Police Department	Minden	Webster	LA	12071620	1
Mineral Wells Police Department	Mineral Wells	Palo Pinto	TX	12187920	2
Minerva Police Department	Minerva	Stark	OH	11154230	1
Minneapolis Park Police Department	Minneapolis	Hennepin	MN	13499440	1
Minneapolis Police Department	Minneapolis	Hennepin	MN	12882650	22
Minnehaha County Sheriff's Office	Sioux Falls	Minnehaha	SD	13651260	1
Minnesota State Patrol	St. Paul	Ramsey	MN	13790070	4
Minnetonka Police Department	Minnetonka	Hennepin	MN	12962690	3
Minocqua Police Department	Minocqua	Oneida	WI	12867020	1

Mint Hill Police Department	Mint Hill	Mecklenburg	NC	12373710	1
Miramar Police Department	Miramar	Broward	FL	13547050	2
Mission Police Department	Mission	Hidalgo	TX	12417960	2
Mississippi Department of Wildlife, Fisheries & Parks	Jackson	Hinds	MS	13252320	3
Mississippi Highway Safety Patrol	Jackson	Hinds	MS	13651560	8
Missoula Police Department	Missoula	Missoula	MT	12873920	1
Missouri Department of Corrections	Jefferson City	Cole	MO	99900166	1
Missouri University of Science And Technology Police Dept	Rolla	Phelps	MO	13818380	1
Missouri Valley Police Department	Missouri Valley	Harrison	IA	13114010	1
MIT Police Department	Cambridge	Middlesex	MA	99900096	1
Moab Police Department	Moab	Grand	UT	12177640	1
Moberly Police Department	Moberly	Randolph	MO	12592270	1
Mobile Police Department	Mobile	Mobile	AL	13610360	4
Modesto Police Department	Modesto	Stanislaus	CA	13421740	6
Moline Police Department	Moline	Rock Island	IL	12500940	1
Moncks Corner Police Department	Moncks Corner	Berkeley	SC	13341430	1
Monmouth County Sheriff's Office	Freehold	Monmouth	NJ	11899740	1
Monongahela City Police	Monongahela	Washington	PA	12705190	1
Monroe County Sheriff's Office	Sparta	Monroe	WI	11529710	2
Monroe County Sheriff's Office	Rochester	Monroe	NY	13001500	3
Monroe County Sheriff's Office	Key West	Monroe	FL	13479940	3
Monroe Police Department	Monroe	Ouachita	LA	12101650	1
Monroe Public Safety	Monroe	Union	NC	13690960	1
Monroeville Police Department	Monroeville	Huron	OH	11724230	1
Monroeville Police Department	Monroeville	Allegheny	PA	12895160	1
Mont Vernon Police Department	Mount Vernon	Hillsborough	NH	13260920	1
Montague County Sheriff's Office	Montague	Montague	TX	11819780	2
Montevallo Police Department	Montevallo	Shelby	AL	13923990	1
Montezuma Police Department	Montezuma	Macon	GA	13120410	2
Montgomery County Police Department	Rockville	Montgomery	MD	11571250	16
Montgomery County Sheriff's Office	Clarksville	Montgomery	TN	13203220	1
Montgomery County Sheriff's Office	Dayton	Montgomery	OH	13233420	1
Montgomery Police Department	Montgomery	Montgomery	AL	11146780	9
Montgomery Police Department	Montgomery	Fayette	WV	11308860	2
Montgomery Town Police Department	Montgomery	Orange	NY	12954790	2
Monticello Police	Monticello	White	IN	12450490	1

Montpelier Police Department	Montpelier	Bear Lake	ID	13391230	1
Moore Township Police Department	Bath	Northampton	PA	12995190	2
Moorestown Township Police	Moorestown	Burlington	NJ	12073110	4
Mooresville Police	Mooresville	Morgan	IN	12150410	1
Moosic Borough Police Department	Moosic	Lackawanna	PA	12455160	1
Mora County Sheriff's Office	Mora	Mora	NM	13689960	1
Morgan County Sheriff's Office	Decatur	Morgan	AL	11419700	1
Morgan County Sheriff's Office	Martinsville	Morgan	IN	13704070	2
Morningside Police Department	Suitland	Prince Georges	MD	11941270	1
Morris County Sheriff's Office	Morristown	Morris	NJ	12339740	1
Morristown Police	Morristown	Morris	NJ	12403130	1
Morrisville State College Police	Morrisville	Madison	NY	13744770	1
Morrow County Sheriff's Office	Heppner	Morrow	OR	13953890	1
Morrow Police Department	Morrow	Clayton	GA	13728970	1
Morton Police Dept	Morton	Tazewell	IL	12630910	1
Mosby Police Department	Mosby	Clay	MO	12532250	1
Moss Point Police Department	Moss Point	Jackson	MS	11602040	2
Moulton Police Department	Moulton	Lawrence	AL	13226120	1
Mounds Police Dept	Mounds	Pulaski	IL	12230920	2
Mount Airy Police Department	Mount Airy	Surry	NC	12483720	1
Mount Gilead Police Department	Mount Gilead	Morrow	OH	12004240	1
Mount Healthy Police Department	Cincinnati	Hamilton	OH	12944260	1
Mount Holly Township Police	Mount Holly	Burlington	NJ	12503100	1
Mount Hope Police Department	Mount Hope	Fayette	WV	11168850	3
Mount Kisco Village Police Department	Mount Kisco	Westchester	NY	12584740	1
Mount Pleasant Police Department	Mt. Pleasant	Titus	TX	12047970	1
Mount Pleasant Police Department	Mount Pleasant	Charleston	SC	13614360	1
Mount Rainier Police Department	Mt. Rainier	Prince Georges	MD	11851270	1
Mount Vernon Police Department	Mount Vernon	Westchester	NY	12554740	1
Mount Washington Police Department	Mount Washington	Bullitt	KY	12661850	3
Mountlake Terrace Police Department	Mountlake Terrace	Snohomish	WA	11407310	1
Muhlenberg Township Police Department	Temple	Berks	PA	12375110	1
Mukwonago Police Department	Mukwonago	Waukesha	WI	12817000	1
Mulberry Police Department	Mulberry	Polk	FL	13893580	1
Muncie Police	Muncie	Delaware	IN	11460470	3
Munhall Borough Police Department	Homestead	Allegheny	PA	12885180	2

Murfreesboro Police Department	Murfreesboro	Rutherford	TN	11286490	6
Murphy Police Department	Murphy	Cherokee	NC	12913740	1
Murray Police Department	Murray	Calloway	KY	12071800	1
Muscatine Police Department	Muscatine	Muscatine	IA	13795270	1
Muskegon Heights Police Department	Muskegon	Muskegon	MI	12922870	1
Muskogee County Sheriff's Office	Muskogee	Muskogee	OK	12349720	1
Muskogee Police Department	Muskogee	Muskogee	OK	12515800	10
Mustang Police Department	Mustang	Canadian	OK	12175870	1
Myrtle Beach Police Department	Myrtle Beach	Horry	SC	13993690	5
Naperville Police Dept	Naperville	Du Page	IL	12130910	1
Nashua Police Department	Nashua	Hillsborough	NH	13819580	1
Nashville Metro Police Department	Nashville	Davidson	TN	11846420	21
Nashville Police	Nashville	Brown	IN	11200460	1
Nashville Police Department	Nashville	Berrien	GA	13687360	1
Nassau County Police Department	Mineola	Nassau	NY	12974750	6
Nassau County Sheriff's Office	Yulee	Nassau	FL	12059750	2
Natchez Police Dept.	Natchez	Adams	MS	11462030	6
Natchitoches Parish Sheriff's Office	Natchitoches	Natchitoches	LA	13523250	3
Naugatuck Police Department	Naugatuck	New Haven	CT	13099000	2
Navajo Nation Tribal Department of Law Enforcement	Window Rock	Apache	AZ	13381830	3
Navassa Police Department	Navassa	Brunswick	NC	12353720	2
Nebraska City Police Dept	Nebraska City	Otoe	NE	12733510	2
Nebraska State Patrol	Lincoln	Lancaster	NE	13293320	1
Needham Police Department	Needham	Norfolk	MA	12421410	1
Nevada Highway Patrol	Carson City	Carson	NV	13844380	6
New Albany Police	New Albany	Floyd	IN	11510460	1
New Athens Police Department	New Athens	Harrison	OH	99900012	1
New Bedford Police Department	New Bedford	Bristol	MA	12481470	3
New Bern Police Department	New Bern	Craven	NC	12573780	1
New Braunfels Police Department	New Braunfels	Comal	TX	13834680	2
New Britain Borough Police Department	Doylestown	Bucks	PA	12655140	1
New Britain Police Department	New Britain	Hartford	CT	13743070	2
New Brunswick Police	New Brunswick	Middlesex	NJ	12913190	3
New Castle (city) Police Department	New Castle	Lawrence	PA	12355160	2
New Castle County Police Department	New Castle	New Castle	DE	13672160	3
New Castle Police	New Castle	Henry	IN	11410480	1

New Castle Police Department	New Castle	Rockingham	NH	11643360	1
New Castle Police Department	New Castle	Garfield	CO	13383330	1
New Ellenton Police Department	New Ellenton	Aiken	SC	12746630	1
New Hampshire State Police	Concord	Merrimack	NH	13164810	3
New Hanover County Sheriff's Office	Castle Hayne	New Hanover	NC	13829480	4
New Haven Police Department	New Haven	New Haven	CT	13787170	9
New Hope Borough Police Department	New Hope	Bucks	PA	12795120	1
New Jersey Department of Environmental Protection	Trenton	Burlington	NJ	13100910	1
New Jersey State Police	West Trenton	Mercer	NJ	11285940	16
New Jersey Transit Police	Newark	Essex	NJ	13415440	3
New Lisbon Police Department	New Lisbon	Juneau	WI	12017020	1
New London Police Department	New London	New London	CT	13142710	2
New Martinsville Police Department	New Martinsville	Wetzel	WV	11798820	1
New Melle Police Department	New Melle	St. Charles	MO	12192220	2
New Mexico Department Of Game & Fish	Santa Fe	Santa Fe	NM	13953290	1
New Mexico State Police	Santa Fe	Santa Fe	NM	13671560	13
New Milford Police Department	New Milford	Litchfield	CT	13195110	1
New Orleans Police Department	New Orleans	Orleans	LA	11181690	98
New Port Richey Police Department	New Port Richey	Pasco	FL	13456840	1
New Rochelle Police Department	New Rochelle	Westchester	NY	12884600	2
New York City Department of Environmental Protection Police	Valhalla	Westchester	NY	13218020	1
New York City Police Department	New York	New York	NY	12414630	229
New York City Sheriff's Office	New York	New York	NY	12639700	2
New York State Courts Officers	New York	New York	NY	99900167	1
New York State Metropolitan Transportation Authority Police	New York	New York	NY	13880680	2
New York State Park Police	Albany	Albany	NY	13797870	1
New York State Police	Albany	Albany	NY	13651360	5
Newark Division of Police	Newark	Licking	OH	11644150	1
Newark Police	Newark	Essex	NJ	12593130	9
Newark Police Department	Newark	New Castle	DE	11881820	1
Newaygo County Sheriff's Office	White Cloud	Newaygo	MI	12769700	1
Newburgh City Police Department	Newburgh	Orange	NY	12574640	1
Newbury Police Department	Newbury	Merrimack	NH	11593370	1
Newnan Police Department	Newnan	Coweta	GA	13891280	1
Newport Beach Police Department	Newport Beach	Orange	CA	13916090	1
Newport News Police Department	Newport News	Newport News City	VA	12617570	12

Newport Police Department	Newport	Sullivan	NH	11771780	1
Newport Police Department	Newport	Campbell	KY	12761830	3
Newport Township Police Department	Nanticoke	Luzerne	PA	12115170	1
Newton County Sheriff's Office	Covington	Newton	GA	12879780	1
Newton Police Department	Newton	Middlesex	MA	12141410	1
Newtown Police Department	Cincinnati	Hamilton	OH	11134150	1
Newtown Police Department	Newtown	Fairfield	CT	13228920	2
Nez Perce County Sheriff's Office	Lewiston	Nez Perce	ID	13328530	2
Niagara County Sheriff's Office	Lockport	Niagara	NY	13038200	1
Niagara Falls Police Department	Niagara Falls	Niagara	NY	12784660	5
Nicholas County Sheriff's Office	Carlisle	Nicholas	KY	13236020	1
Nicoma Park Police Department	Nicoma Park	Oklahoma	OK	12035820	1
Niles Police Department	Niles	Berrien	MI	12152860	1
Niles Police Dept	Niles	Cook	IL	12400990	1
Noble Police Department	Noble	Cleveland	OK	12885880	3
Noblesville Police	Noblesville	Hamilton	IN	12730400	1
Nogales Police Department	Nogales	Santa Cruz	AZ	13207620	2
Norfolk (City) Sheriff's Office	Norfolk	Norfolk City	VA	12799730	1
Norfolk Police Department	Norfolk	Norfolk City	VA	12937520	15
Normandy Police Department	Normandy	St. Louis	MO	12132230	1
North Adams Police Department	North Adams	Berkshire	MA	12601400	1
North Augusta Public Safety	North Augusta	Aiken	SC	12756640	2
North Bergen Police	North Bergen	Hudson	NJ	12713120	1
North Brunswick Police	North Brunswick	Middlesex	NJ	12323170	1
North Carolina State Highway Patrol	Raleigh	Wake	NC	13708270	9
North Catasauqua Borough Police Department	Catasauqua	Northampton	PA	12645070	1
North Charleston Police Department	North Charleston	Charleston	SC	12336690	5
North Cornwall Township Police Department	Lebanon	Lebanon	PA	12115080	1
North Courtland Police Department	North Courtland	Lawrence	AL	13270120	2
North Forest I.S.D. Police Dept.	Houston	Harris	TX	13221520	1
North Kingsville Police Department	North Kingsville	Ashtabula	OH	11384180	2
North Las Vegas Police Department	North Las Vegas	Clark	NV	12684960	2
North Muskegon Police Department	Muskegon	Muskegon	MI	12052880	1
North Pekin Police Dept	North Pekin	Tazewell	IL	12770980	2
North Providence Police Department	No. Providence	Providence	RI	11426750	9
North Randall Police Department	North Randall	Cuyahoga	OH	11944140	1

North Syracuse Village Police Department	North Syracuse	Onondaga	NY	12784690	3
North Topsail Beach Police Department	North Topsail Bch	Onslow	NC	12613790	1
Northampton Police Department	Northampton	Hampshire	MA	12661490	1
Northbridge Police Department	Northbridge	Worcester	MA	12441400	2
Northern Cambria Borough Police Department	Barnesboro	Cambria	PA	12845050	1
Northern Illinois University Police	Dekalb	DeKalb	IL	11764970	1
Northside I.S.D. Police Dept.	San Antonio	Bexar	TX	13083900	2
Northwoods Police Department	Northwoods	St. Louis	MO	13679060	1
Norton Police Department	Norton	Norton	KS	12780170	2
Norwalk Police Department	Norwalk	Fairfield	CT	13459140	6
Norwich Police Department	Norwich	Chenango	NY	12464680	1
Norwich Police Department	Norwich	New London	CT	13340530	6
Nueces County Constable Pct. 3	Bishop	Nueces	TX	13642860	1
Nye County Sheriff's Office	Pahrump	Nye	NV	13250920	3
O'Fallon Police Department	O'Fallon	St. Charles	MO	13342230	1
Oak Lawn Police Dept	Oak Lawn	Cook	IL	12640830	1
Oak Park Police Dept	Oak Park	Cook	IL	12880850	1
Oakdale Police Department	Oakdale	Allen	LA	11711660	1
Oakland Police Department	Oakland	Alameda	CA	13387330	7
Oakland Police Department	Oakland	Orange	FL	13399830	1
Oakwood Police Department	Oakwood	Paulding	OH	11974140	1
Oakwood Village Police Department	Bedford	Cuyahoga	OH	13090300	1
Ocala Police Department	Ocala	Marion	FL	13824680	2
Ocean Beach Village Police Dept	Ocean Beach	Suffolk	NY	13240620	4
Ocean City Police Department	Ocean City	Worcester	MD	11891250	1
Ocean Shores Police Department	Ocean Shores	Grays Harbor	WA	13701370	1
Ocean Springs Police Department	Ocean Springs	Jackson	MS	11382010	2
Ocean View Police Department	Ocean View	Sussex	DE	11596670	1
Oceanside Police Department	Oceanside	San Diego	CA	13563250	4
Ocoee Police Department	Ocoee	Orange	FL	13313730	1
Ogden Police Department	Ogden	Weber	UT	13172610	2
Ogdensburg Police Department	Ogdensburg	St. Lawrence	NY	13370830	1
Oglesby Police Dept	Oglesby	La Salle	IL	12860800	1
Oglethorpe County Sheriff's Office	Lexington	Oglethorpe	GA	12069700	1
Oglethorpe Police Department	Oglethorpe	Macon	GA	13161210	1
Ohio Department of Natural Resources - Office of Law Enforcement	Columbus	Franklin	OH	13648660	2

Ohio Department of Taxation - Enforcement Division	Columbus	Franklin	OH	99900019	1
Ohio State Highway Patrol	Columbus	Franklin	OH	13873780	4
Ohio State University Police Department	Columbus	Franklin	OH	13517650	1
Okaloosa County Sheriff's Office	Shalimar	Okaloosa	FL	13308630	4
Okanogan County Sheriff's Office	Okanogan	Okanogan	WA	12879750	1
Okay Police Department	Okay	Wagoner	OK	12205860	1
Oklahoma City Police Department	Okla. City	Oklahoma	OK	12515860	17
Oklahoma Department of Public Safety	Okla. City	Oklahoma	OK	13400740	6
Olanta Police Department	Olanta	Florence	SC	12566640	1
Olathe Police Department	Olathe	Johnson	KS	12380180	1
Old Forge Borough Police Department	Old Forge	Lackawanna	PA	12555040	1
Oldham County Police Department	Lagrange	Oldham	KY	12461870	2
Olean Police Department	Olean	Cattaraugus	NY	13522550	1
Olmsted Township Police Department	Olmsted Twp.	Cuyahoga	OH	13452740	1
Olney Police Department	Olney	Young	TX	12457940	1
Olyphant Borough Police Department	Olyphant	Lackawanna	PA	12065090	1
Omaha Police Dept	Omaha	Douglas	NE	12783590	6
Onley Police Department	Onley	Accomack	VA	12327570	1
Onondaga County Sheriff's Office	Syracuse	Onondaga	NY	13679960	1
Ontario Police Department	Ontario	Malheur	OR	11625600	1
Opa Locka Police Department	Opa Locka	Miami-Dade	FL	13346830	3
Opelika Police Department	Opelika	Lee	AL	13217820	1
Opelousas Police Department	Opelousas	St. Landry	LA	11231680	1
Orange County Sheriff-Coroner Department	Santa Ana	Orange	CA	13955890	22
Orange County Sheriff's Office	Goshen	Orange	NY	12039610	1
Orange County Sheriff's Office	Hillsborough	Orange	NC	13731470	1
Orange County Sheriff's Office	Orlando	Orange	FL	13823880	17
Orange Police Department	Orange	New Haven	CT	13384630	1
Orangeburg County Sheriff's Office	Orangeburg	Orangeburg	SC	12519610	1
Orangeburg Public Safety	Orangeburg	Orangeburg	SC	12686660	4
Orangetown Town Police Department	Orangeburg	Rockland	NY	12314690	1
Oregon County Sheriff's Office	Alton	Oregon	MO	12139640	2
Orem Department of Public Safety	Orem	Utah	UT	13060000	1
Orlando Police Department	Orlando	Orange	FL	13908790	8
Orleans County Sheriff's Office	Albion	Orleans	NY	12869680	2
Orleans Parish Sheriff's Office (Criminal Division)	New Orleans	Orleans	LA	13457940	4

Orleans Police Department	Orleans	Barnstable	MA	11511370	1
Oro Valley Police Department	Oro Valley	Pima	AZ	13905390	1
Osawatomie Department of Public Safety	Osawatomie	Miami	KS	12670150	1
Osceola County Sheriff's Office	Reed City	Osceola	MI	12969680	1
Osceola County Sheriff's Office	Kissimmee	Osceola	FL	13308230	2
Osceola Police Department	Osceola	Clarke	IA	13926290	1
Oswego Police Department	Oswego	Oswego	NY	12604600	1
Otero County Sheriff's Office	Alamogordo	Otero	NM	12809650	1
Ottawa County Sheriff's Office	West Olive	Ottawa	MI	13237320	1
Ottawa Hills Police Department	Toledo	Lucas	OH	13948390	1
Ouachita Parish Sheriff's Office	Monroe	Ouachita	LA	13218120	1
Outagamie County Sheriff's Office	Appleton	Outagamie	WI	12399620	1
Overland Police Department	Overland	St. Louis	MO	12412250	1
Owens Crossroad Police Department	Owens Crossroad	Madison	AL	11659230	1
Oxford Police Department	Oxford	New Haven	CT	11658010	1
Oxford Police Department	Oxford	Butler	OH	13086100	2
Oxford Township Police	Oxford	Warren	NJ	12383140	2
Oxnard Police Department	Oxnard	Ventura	CA	13539450	4
Ozaukee County Sheriff's Office	Port Washington	Ozaukee	WI	12599690	1
Pacific Police Department	Pacific	King	WA	11767350	1
Pacific Police Department	Pacific	Franklin	MO	12702290	1
Page County Sheriff's Office	Luray	Page	VA	12769640	13
Palatka Police Department	Palatka	Putnam	FL	13472040	1
Palisade Police Dept	Palisade	Mesa	CO	11284970	1
Palm Bay Police Department	Palm Bay	Brevard	FL	13140510	1
Palm Beach County School District Police	West Palm Beach	Palm Beach	FL	13797570	5
Palm Beach County Sheriff's Office	West Palm Beach	Palm Beach	FL	13141210	13
Palm Beach Gardens Police Department	Palm Beach Gardens	Palm Beach	FL	13631660	2
Palm Springs Police Department	Palm Springs	Riverside	CA	13209920	1
Palmer Township Police Department	Easton	Northampton	PA	11075010	1
Palo Alto Police Department	Palo Alto	Santa Clara	CA	13519250	1
Palos Verdes Estates Police Department	Palos Verdes Estates	Los Angeles	CA	13250820	1
Panama City Police Department	Panama City	Bay	FL	13566150	1
Paola Police Department	Paola	Miami	KS	12100090	2
Paris Police Department	Paris	Lamar	TX	12727950	1
Park Ridge Police Dept	Park Ridge	Cook	IL	12430870	2

Parker Police Department	Parker	Bay	FL	13252720	2
Parma Heights Police Department	Parma Heights	Cuyahoga	OH	12804190	1
Parma Police Department	Parma	Cuyahoga	OH	13225220	3
Pasadena Police Department	Pasadena	Harris	TX	12967940	5
Pasco County Sheriff's Office	New Port Richey	Pasco	FL	13290020	4
Passaic County Sheriff's Office	Wayne	Passaic	NJ	13930390	7
Paterson Police	Paterson	Passaic	NJ	12743090	4
Paulding County Sheriff's Office	Dallas	Paulding	GA	13383430	1
Pauls Valley Police Department	Pauls Valley	Garvin	OK	11925710	1
Pawnee County Sheriff's Office	Pawnee	Pawnee	OK	12959640	1
Pawtucket Police Department	Pawtucket	Providence	RI	12206780	2
Peachtree City Police Dept	Peachtree City	Fayette	GA	13329930	1
Pearl Police Department	Pearl	Rankin	MS	11012050	2
Pearson Police Department	Pearson	Atkinson	GA	13245020	1
Pelham Police Department	Pelham	Hampshire	MA	11211360	1
Pelham Police Department	Pelham	Mitchell	GA	13717070	1
Pembroke Pines Police Department	Pembroke Pines	Broward	FL	13658960	1
Pendel Borough Police Department	Pendel	Bucks	PA	99900099	1
Pender County Sheriff's Office	Burgaw	Pender	NC	13681160	1
Penn Hills Township Police Department	Pittsburgh	Allegheny	PA	11855060	1
Pennington County Sheriff's Office	Rapid City	Pennington	SD	13359330	1
Pennsylvania Department of Conservation and Natural Resources	Harrisburg	Dauphin	PA	99900011	1
Pennsylvania State Constable--Allegheny County	Pittsburgh	Allegheny	PA	99900029	3
Pennsylvania State Constable--Montgomery County	Norristown	Montgomery	PA	99900073	1
Pennsylvania State Police	Harrisburg	Dauphin	PA	11916890	36
Pensacola Police Department	Pensacola	Escambia	FL	13928190	1
Peoria Police Department	Peoria	Maricopa	AZ	13804680	1
Peoria Police Dept	Peoria	Peoria	IL	12990860	1
Perry County Sheriff's Office	Pinckneyville	Perry	IL	13112210	1
Perry Police Department	Perry	Box Elder	UT	13282120	1
Perry Township Police Department	Massillon	Stark	OH	12474170	2
Perrysburg Police Department	Perrysburg	Wood	OH	12424120	2
Perrysburg Township Police Department	Perrysburg	Wood	OH	12144160	1
Perryville Police Department	Perryville	Boyle	KY	12381860	1
Petal Police Department	Petal	Forrest	MS	11352010	4
Petersburg Police Department	Petersburg	Petersburg City	VA	12097560	3

Petroleum County Sheriff's Office	Winnett	Petroleum	MT	11169640	1
Pewaukee (city) Police Department	Pewaukee	Waukesha	WI	11877030	1
Pharr Police Department	Pharr	Hidalgo	TX	12137930	2
Philadelphia Police Department	Philadelphia	Neshoba	MS	11652060	1
Philadelphia Police Department	Philadelphia	Philadelphia	PA	12035060	70
Phillips County Sheriff's Office	Helena	Phillips	AR	11719620	1
Phoenix Police Department	Phoenix	Maricopa	AZ	13934890	17
Pickens Police Department	Pickens	Pickens	SC	11546650	1
Piedmont Police Department	Piedmont	Calhoun	AL	13246920	1
Pierce County Sheriff's Office	Tacoma	Pierce	WA	13244620	2
Pilot Point Police Department	Pilot Point	Denton	TX	12917950	2
Pima County Sheriff's Dept.	Tucson	Pima	AZ	13536450	1
Pinal County Sheriff's Office	Florence	Pinal	AZ	13565450	2
Pinckney Police Department	Pinckney	Livingston	MI	12362850	1
Pine Bluff Police Department	Pine Bluff	Jefferson	AR	13602860	1
Pine Lake Police Department	Pine Lake	DeKalb	GA	13975090	1
Pine Lawn Police Department	Pine Lawn	St. Louis	MO	12892260	2
Pineland Police Department	Pineland	Sabine	TX	12137810	1
Pinellas County Sheriff's Office	Largo	Pinellas	FL	13244220	8
Pinellas Park Police Department	Pinellas Park	Pinellas	FL	13147710	2
Pinetops Police Department	Pinetops	Edgecombe	NC	12393790	1
Pineview Police Department	Pineview	Wilcox	GA	13484940	1
Pineville Police Department	Pineville	Rapides	LA	11451620	1
Pink Hill Police Department	Pink Hill	Lenoir	NC	12553790	1
Piscataway Township Police	Piscataway	Middlesex	NJ	12543080	1
Pitt County Sheriff's Office	Greenville	Pitt	NC	13264420	3
Pittsboro Police	Pittsboro	Hendricks	IN	12810470	1
Pittsburgh Police Department	Pittsburgh	Allegheny	PA	12355030	26
Pittston City Police Department	Pittston	Luzerne	PA	12165000	1
Placer County Sheriff's Office	Auburn	Placer	CA	13787070	2
Plainfield Police Department	Plainfield	Union	NJ	13551650	5
Plainfield Township Police Department	Nazareth	Northampton	PA	12275050	2
Plainview Police Department	Plainview	Hale	TX	12347800	1
Plano Police Department	Plano	Collin	TX	12147880	1
Plaquemines Parish Sheriff's Office	Belle Chasse	Plaquemines	LA	13820980	1
Platteville Police Department	Platteville	Grant	WI	11167080	1

Platteville Police Dept	Platteville	Weld	CO	13254820	2
Plattsburgh Police Department	Plattsburgh	Clinton	NY	11676560	1
Pleasant Hill Police Department	Pleasant Hill	Polk	IA	13354230	2
Pleasant Valley Police Department	Pleasant Valley	Clay	MO	12842240	1
Pleasanton Police Department	Pleasanton	Alameda	CA	13430640	1
Plum Borough Police Department	Pittsburgh	Allegheny	PA	12795030	1
Plymouth Township Police Department	Plymouth Meeting	Montgomery	PA	12635030	1
Pocahontas County Sheriff's Office	Marlinton	Pocahontas	WV	12589650	1
Pocola Police Department	Pocola	Le Flore	OK	11155790	1
Pohatcong Township Police	Philipsburg	Warren	NJ	13026100	1
Point Pleasant Borough Police	Point Pleasant	Ocean	NJ	13612660	1
Pojoaque Tribal Police Department	Santa Fe	Santa Fe	NM	13390230	2
Polk County Police Department	Cedartown	Polk	GA	13662160	3
Polk County Sheriff's Office	Cedartown	Polk	GA	12289630	3
Polk County Sheriff's Office	Bartow	Polk	FL	13297720	14
Polk County Sheriff's Office	Des Moines	Polk	IA	13511750	3
Pompton Lakes Police	Pompton Lakes	Passaic	NJ	13355930	3
Ponchatoula Police Department	Ponchatoula	Tangipahoa	LA	12411640	1
Pontiac Police Department	Pontiac	Oakland	MI	11762840	4
Pontoon Beach Police Dept	Pontoon Beach	Madison	IL	13630660	2
Poplar Bluff Police Department	Poplar Bluff	Butler	MO	11972210	1
Poquoson Police Department	Poquoson	Poquoson City	VA	12817520	1
Port Authority of New York & New Jersey Police Department	Jersey City	Hudson	NJ	13915290	1
Port Barre Police Dept	Port Barre	St. Landry	LA	11990094	1
Port Huron Police Department	Port Huron	St. Clair	MI	11022820	1
Port Jefferson Police Department	Port Jefferson	Shelby	OH	99900105	1
Port Orange Police Department	Port Orange	Volusia	FL	13542550	2
Port Orchard Police Department	Port Orchard	Kitsap	WA	12177360	1
Port Richey Police Department	Port Richey	Pasco	FL	13276320	1
Port St. Lucie Police Department	Port St. Lucie	St. Lucie	FL	13671160	1
Port Vue Borough Police Department	Mc Keesport	Allegheny	PA	12855030	5
Portage County Sheriff's Office	Ravenna	Portage	OH	12939680	1
Porter County Sheriff's Office	Valparaiso	Porter	IN	12019680	2
Portland Police Bureau	Portland	Multnomah	OR	12805650	26
Portland Police Department	Portland	Cumberland	ME	12961140	4
Portsmouth Police Department	Portsmouth	Portsmouth City	VA	12037590	11

Portsmouth Police Department	Portsmouth	Rockingham	NH	12883380	1
Pottawattamie County Sheriff's Office	Council Bluffs	Pottawattomie	IA	13094900	1
Potter County Sheriff's Office	Amarillo	Potter	TX	13733770	2
Poughkeepsie Police Department	Poughkeepsie	Dutchess	NY	11624650	1
Powell County Sheriff's Office	Deer Lodge	Powell	MT	12829610	1
Prattville Police Department	Prattville	Autauga	AL	13159110	1
Prescott Police Department	Prescott	Pierce	WI	12537040	1
Prince George's County Police Department	Landover	Prince Georges	MD	11801260	30
Prince George's County Sheriff's Office	Upper Marlboro	Prince Georges	MD	13865780	3
Prince William County Police Department	Prince William	Prince William	VA	12017510	3
Prince William County Sheriff's Office	Manassas	Prince William	VA	11179530	1
Princeton Borough Police	Princeton	Mercer	NJ	13995390	1
Princeton Police Department	Princeton	Mercer	WV	12708880	2
Prior Lake Police Department	Prior Lake	Scott	MN	11942580	1
Providence Police Department	Providence	Webster	KY	12171870	1
Providence Police Department	Providence	Providence	RI	12356710	7
Provo Police Department	Provo	Utah	UT	12717610	3
Pueblo Police Dept	Pueblo	Pueblo	CO	13667460	4
Pulaski County Sheriff's Office	Mound City	Pulaski	IL	11559500	3
Pulaski Police Department	Pulaski	Pulaski	VA	12137540	3
Purcell Police Department	Purcell	McClain	OK	11185720	2
Putnam County Sheriff's Office	Cookeville	Putnam	TN	11369530	2
Puyallup Police Department	Puyallup	Pierce	WA	12937360	1
Queen Anne's County Sheriff's Office	Centreville	Queen Annes	MD	11499500	1
Quincy Police Department	Quincy	Norfolk	MA	11141380	1
Quincy Police Department	Quincy	Grant	WA	12037350	1
Racine Police Department	Racine	Racine	WI	12677080	1
Radcliff Police Department	Radcliff	Hardin	KY	12031860	1
Rainsville Police Department	Rainsville	DeKalb	AL	13045900	1
Raleigh Police Department	Raleigh	Wake	NC	12513750	8
Ramapo Town Police Department	Suffern	Rockland	NY	11064660	2
Ramsey County Sheriff's Office	Saint Paul	Ramsey	MN	13160810	2
Ramsey Police	Ramsey	Bergen	NJ	13507650	1
Randolph County Sheriff's Office	Chester	Randolph	IL	13288020	1
Randolph Police Department	Randolph	Clay	MO	13586050	1
Ranger Police Department	Ranger	Eastland	TX	13473040	1

Rapid City Police Department	Rapid City	Pennington	SD	13888280	2
Rapides Parish Sheriff's Office	Alexandria	Rapides	LA	13119910	3
Ravalli County Sheriff's Office	Hamilton	Ravalli	MT	13491040	1
Ravenna Police Dept	Ravenna	Buffalo	NE	12513480	1
Red Bank Police	Red Bank	Monmouth	NJ	12273060	1
Red Springs Police Department	Red Springs	Robeson	NC	12803700	1
Redding Police Department	Redding	Shasta	CA	13531350	1
Redmond Police Department	Redmond	Deschutes	OR	12345660	2
Redondo Beach Police Department	Redondo Beach	Los Angeles	CA	13884880	1
Reidsville Police Department	Reidsville	Rockingham	NC	12633780	1
Reno Police Department	Reno	Washoe	NV	12564930	3
Revere Police Department	Revere	Suffolk	MA	11661330	1
Reynoldsburg Police Department	Reynoldsburg	Franklin	OH	12914140	1
Rhode Island State Police	North Scituate	Providence	RI	13892980	2
Richfield Police Department	Richfield	Hennepin	MN	12442500	3
Richland County Sheriff's Office	Columbia	Richland	SC	13007300	3
Richland Police Dept	Richland	Pulaski	MO	13333430	1
Richmond (City) Sheriff's Office	Richmond	Richmond City	VA	12259540	2
Richmond County Sheriff's Office	Augusta	Richmond	GA	13743570	5
Richmond Police Department	Richmond	Ray	MO	11391750	1
Richmond Police Department	Richmond	Richmond City	VA	12037560	8
Richmond Police Department	Richmond	Madison	KY	12451800	1
Richmond Police Department	Richmond	Contra Costa	CA	13237220	4
Richmond Police Dept	Richmond	McHenry	IL	11200830	1
Ridgefield Police Department	Ridgefield	Fairfield	CT	13539850	1
Ridgeville Police	Ridgeville	Randolph	IN	11020320	3
Ridgeville Police Department	Ridgeville	Dorchester	SC	11366630	1
Ridley Township Police Department	Folsom	Delaware	PA	11926960	1
Riley County Police Department	Manhattan	Riley	KS	12580040	1
Ringwood Borough Police	Ringwood	Passaic	NJ	12523000	1
Rio Arriba County Sheriff's Office	Espanola	Rio Arriba	NM	12469560	1
Ripley Police Department	Ripley	Jackson	WV	12488880	1
River Rouge Police Department	River Rouge	Wayne	MI	11732840	2
Riverdale Park Police Department	Riverdale Park	Prince Georges	MD	12251270	1
Riverside County Sheriff's Office	Riverside	Riverside	CA	13056100	14
Riverside Police Department	Riverside	Riverside	CA	13931490	12

Riverton Borough Police	Riverton	Burlington	NJ	12103080	1
Riviera Beach Police Department	Riviera Beach	Palm Beach	FL	13178410	6
Roanoke City Police Department	Roanoke	Roanoke City	VA	12767530	2
Roanoke County Police Department	Roanoke	Roanoke	VA	12317530	2
Robbins Police Department	Robbins	Moore	NC	12983720	1
Robbins Police Dept	Robbins	Cook	IL	11980880	2
Robbinsdale Police Department	Robbinsdale	Hennepin	MN	13884080	1
Robeson County Sheriff's Office	Lumberton	Robeson	NC	12639510	3
Robinson Police Department	Robinson	McLennan	TX	12467860	1
Robinson Township Police Department	Pittsburgh	Allegheny	PA	11556900	1
Rochelle Police Department	Rochelle	Wilcox	GA	13774070	1
Rochester Police Department	Rochester	Monroe	NY	11484610	3
Rochester Police Department	Rochester	Olmsted	MN	13660160	1
Rock County Sheriff's Office	Janesville	Rock	WI	13817580	2
Rock Hill Police Department	Rock Hill	York	SC	11806690	3
Rockford Police Dept	Rockford	Winnebago	IL	11360890	1
Rockingham County Sheriff's Office	Harrisonburg	Rockingham	VA	13288820	1
Rockledge Police Department	Rockledge	Brevard	FL	13641460	1
Rockmart Police Department	Rockmart	Polk	GA	13257220	1
Rockport Police Department	Rockport	Essex	MA	11911330	1
Rockville Police Department	Rockville	Montgomery	MD	12881240	4
Rocky Mount Police Department	Rocky Mount	Nash	NC	12243710	1
Rocky Mount Police Department	Rocky Mount	Franklin	VA	12797560	2
Rogers Police Department	Rogers	Benton	AR	13534450	1
Roman Forest Police Department	Roman Forest	Montgomery	TX	11947830	1
Romulus Police Department	Romulus	Wayne	MI	11092830	6
Roodhouse Police Dept	Roodhouse	Greene	IL	11870840	1
Roosevelt County Sheriff's Office	Wolf Point	Roosevelt	MT	12959580	1
Roseboro Police Department	Roseboro	Sampson	NC	12303760	2
Rosebud Sioux Tribal Police	Rosebud	Todd	SD	11990043	1
Rosedale Police Department	Rosedale	Bolivar	MS	12882010	1
Roseland Police	South Bend	St. Joseph	IN	11120320	1
Roselle Borough Police	Roselle	Union	NJ	13278720	1
Ross Township Police Department	Pittsburgh	Allegheny	PA	11216940	1
Roswell Police Department	Roswell	Chaves	NM	12684990	2
Round Rock Police Department	Round Rock	Williamson	TX	11507890	1

Routt County Sheriff's Office	Steamboat Springs	Routt	CO	13895180	1
Roxbury Township Police	Ledgewood	Morris	NJ	11173090	2
Royal Oak Police Department	Royal Oak	Oakland	MI	11272850	1
Royston Police Department	Royston	Franklin	GA	13551750	1
Ruidoso Police Department	Ruidoso	Lincoln	NM	13346730	1
Russell County Sheriff's Office	Phenix City	Russell	AL	12239590	2
Russellville Police Department	Russellville	Franklin	AL	13758870	8
Rutherford County Sheriff's Office	Murfreesboro	Rutherford	TN	13567350	2
Rutland Police Department	Rutland	Worcester	MA	12361380	2
Rutland Police Department.	Rutland	Rutland	VT	12407400	1
Sacramento County Sheriff's Office	Sacramento	Sacramento	CA	13630060	6
Sacramento Police Department	Sacramento	Sacramento	CA	13762270	6
Sag Harbor Village Police Department	Sag Harbor	Suffolk	NY	11594690	2
Saginaw County Sheriff's Office	Saginaw	Saginaw	MI	13128010	1
Saginaw Police Department	Saginaw	Saginaw	MI	11722860	1
Salem County Sheriff's Office	Salem	Salem	NJ	12299520	1
Salem Police	Salem	Salem	NJ	11803030	1
Salem Police Department	Salem	Essex	MA	12071310	3
Salem Police Department	Salem	Marion	OR	12875690	2
Salinas Police Department	Salinas	Monterey	CA	13753970	4
Saline County Sheriff's Office	Salina	Saline	KS	12859580	1
Saline County Sheriff's Office	Harrisburg	Saline	IL	13221920	1
Salisbury Police Department	Salisbury	Rowan	NC	12103630	1
Salisbury Police Department	Salisbury	Essex	MA	12591390	2
Salisbury Police Department	Salisbury	Wicomico	MD	12881210	1
Sallisaw Police Department	Sallisaw	Sequoyah	OK	13593950	3
Salt Lake City Police Department	Salt Lake City	Salt Lake	UT	12257650	1
Salt Lake County Sheriff's Office	Salt Lake City	Salt Lake	UT	13836780	1
San Antonio Park Rangers	San Antonio	Bexar	TX	13062000	3
San Antonio Police Department	San Antonio	Bexar	TX	11387840	39
San Benito County Sheriff's Office	Hollister	San Benito	CA	12679580	4
San Benito Police Department	San Benito	Cameron	TX	11877820	2
San Bernardino County Sheriff's Office	San Bernardino	San Bernardino	CA	13771270	21
San Bernardino Police Department	San Bernardino	San Bernardino	CA	13415240	2
San Diego County Sheriff's Office	San Diego	San Diego	CA	13846180	7
San Diego Police Department	San Diego	San Diego	CA	13560350	18

San Francisco Police Department	San Francisco	San Francisco	CA	13180510	8
San Jacinto County Sheriff's Office	Coldspring	San Jacinto	TX	12709550	1
San Jose Police Department	San Jose	Santa Clara	CA	13415640	10
San Juan County Sheriff's Office	Aztec	San Juan	NM	12719590	2
San Leandro Police Department	San Leandro	Alameda	CA	11489190	3
San Luis Obispo County Sheriff's Office	San Luis Obispo	San Luis Obispo	CA	13047600	2
San Marcos Police Department	San Marcos	Hays	TX	11867850	1
San Rafael Police Department	San Rafael	Marin	CA	13514050	1
San Ramon Police Department	San Ramon	Contra Costa	CA	13832480	2
Sandoval County Sheriff's Office	Rio Rancho	Sandoval	NM	11255390	1
Sandown Police Department	Sandown	Rockingham	NH	13824080	2
Sandusky Police Department	Sandusky	Erie	OH	12714100	3
Sandwich Police Department	Sandwich	Barnstable	MA	12121360	2
Sandy Police Department	Sandy	Clackamas	OR	12465600	2
Sandy Police Department	Sandy	Salt Lake	UT	12987690	1
Sandy Springs Police Department	Sandy Springs	Fulton	GA	13802480	3
Sanford Police Department	Sanford	Lee	NC	12293630	1
Sanford Police Department	Sanford	Seminole	FL	13333130	1
Sanger Police Department	Sanger	Denton	TX	11997850	1
Santa Ana Unified School District Police Dept.	Santa Ana	Orange	CA	13043000	2
Santa Barbara County Sheriff's Office	Santa Barbara	Santa Barbara	CA	13642660	1
Santa Barbara Police Department	Santa Barbara	Santa Barbara	CA	13877680	4
Santa Clara County Sheriff's Office	San Jose	Santa Clara	CA	11671410	2
Santa Clara Police Department	Santa Clara	Santa Clara	CA	13711170	2
Santa Clara Police Department	Santa Clara	Grant	NM	99900009	1
Santa Clara Tribal Police Department	Espanola	Rio Arriba	NM	12144950	1
Santa Fe County Sheriff's Office	Santa Fe	Santa Fe	NM	12309500	2
Santa Fe Police Department	Santa Fe	Santa Fe	NM	12584980	2
Santa Rosa County Sheriff's Office	Milton	Santa Rosa	FL	13874680	2
Santa Rosa Police Department	Santa Rosa	Cameron	TX	11927810	1
Santee Police Department	Santee	Orangeburg	SC	11126610	2
Sarasota County Sheriff's Office	Sarasota	Sarasota	FL	13855480	1
Saratoga County Sheriff's Office	Ballston Spa	Saratoga	NY	12219540	7
Saratoga Springs Police Department	Saratoga Springs	Saratoga	NY	11714650	1
Saugerties Village Police Department	Saugerties	Ulster	NY	11444630	4
Sauk County Sheriff's Office	Baraboo	Sauk	WI	13474340	1

Saukville Police Department	Saukville	Ozaukee	WI	11048980	1
Sault Ste. Marie Police Department	Sault Sainte Marie	Chippewa	MI	12672870	1
Savannah-Chatham Metropolitan Police Department	Savannah	Chatham	GA	13229520	6
Schenectady Police Department	Schenectady	Schenectady	NY	11034690	16
Schodack Town Police Department	Castleton	Rensselaer	NY	12274680	1
School District of Philadelphia Police	Philadelphia	Philadelphia	PA	11990037	1
Scotia Village Police Department	Scotia	Schenectady	NY	12444660	1
Scotts Hill Police Department	Scotts Hill	Henderson	TN	12226430	1
Scottsbluff Police Dept	Scottsbluff	Scotts Bluff	NE	12203450	1
Scottsboro Police Department	Scottsboro	Jackson	AL	13569050	1
Scottsdale Police Dept	Scottsdale	Maricopa	AZ	13152810	1
Scranton Police Department	Scranton	Lackawanna	PA	12386950	5
Sea Isle Police	Sea Isle	Cape May	NJ	11813040	1
Seabrook Police Department	Seabrook	Rockingham	NH	12363390	1
Seadrift Police Department	Seadrift	Calhoun	TX	11847800	1
Searcy Police Department	Searcy	White	AR	13734370	1
Seaside Park Police	Seaside Park	Ocean	NJ	11693010	1
Seaside Police Department	Seaside	Monterey	CA	11471270	7
Seaside Police Department	Seaside	Clatsop	OR	12255670	2
Seattle Police Department	Seattle	King	WA	12967330	11
Sedalia Police Dept	Sedalia	Pettis	MO	11512260	1
Sedgwick Police Department	Sedgwick	Harvey	KS	12430070	1
Seguin Police Department	Seguin	Guadalupe	TX	12437890	2
Sellersburg Police	Sellersburg	Clark	IN	12960310	1
Selma Police Department	Selma	Fresno	CA	13199610	1
Selma Police Department	Selma	Dallas	AL	13449440	2
Selmer Police Department	Selmer	McNairy	TN	12826490	1
Seminole County Sheriff's Office	Sanford	Seminole	FL	13185110	2
Seminole Tribal Police Department	Hollywood	Broward	FL	13522450	2
Seneca County Sheriff's Office	Romulus	Seneca	NY	12369410	6
Seneca Police Department	Seneca	Oconee	SC	11776630	1
Senoia Police Department	Senoia	Coweta	GA	13126210	3
Sevierville Police Department	Sevierville	Sevier	TN	12386400	1
Seward Police Dept	Seward	Seward	NE	12263450	1
Seymour Police	Seymour	Jackson	IN	12070340	1
Seymour Police Department	Seymour	New Haven	CT	13427240	3

Shafter Police Department	Shafter	Kern	CA	13165510	2
Sharon Hill Borough Police Department	Sharon Hill	Delaware	PA	12456930	2
Sharon Township Police Department	Columbus	Franklin	OH	12824140	1
Sharpsburg Police Department	Sharpsburg	Nash	NC	12643630	1
Shawnee Police Department	Shawnee	Pottawatomie	OK	12295740	1
Sheboygan Falls Police Department	Sheboygan Falls	Sheboygan	WI	11468950	1
Shelby County Sheriff's Office	Center	Shelby	TX	12609420	2
Shelby County Sheriff's Office	Memphis	Shelby	TN	13018600	14
Shelby County Sheriff's Office	Sidney	Shelby	OH	13909990	2
Shelby Police Department	Shelby	Bolivar	MS	11493980	3
Shelby Police Department	Shelby	Cleveland	NC	12713640	1
Shelby Township Police Department	Utica	Macomb	MI	12982800	3
Shelbyville Police Department	Shelbyville	Shelby	KY	11091880	1
Shelton Police Department	Shelton	Fairfield	CT	13851180	3
Shenandoah Borough Police Department	Shenandoah	Schuylkill	PA	12926960	5
Shenandoah Police Department	Shenandoah	Montgomery	TX	12747880	2
Sherman Police Department	Sherman	Grayson	TX	12167840	1
Sherwood Police Department	Sherwood	Washington	OR	12245600	1
Shillington Police Department	Shillington	Berks	PA	12666950	1
Shinnston Police Department	Shinnston	Harrison	WV	12578880	2
Shippensburg University of Pennsylvania Police	Shippensburg	Cumberland	PA	13907190	2
Shively Police Department	Shively	Jefferson	KY	11031890	4
Shreveport Police Department	Shreveport	Caddo	LA	12011620	14
Silverton Police Department	Silverton	Marion	OR	12315600	1
Simpson County Sheriff's Office	Franklin	Simpson	KY	12769430	1
Simpsonville Police Department	Simpsonville	Greenville	SC	11236690	1
Sioux Falls Police Department	Sioux Falls	Minnehaha	SD	11356500	1
Skaneateles Village Police Department	Skaneateles	Onondaga	NY	12964680	1
Slaton Police Department	Slaton	Lubbock	TX	12317800	2
Sleepy Eye Police Department	Sleepy Eye	Redwood	MN	12632560	1
Sleepy Hollow Village Police Department	Sleepy Hollow	Westchester	NY	12124630	2
Slidell Police Department	Slidell	St. Tammany	LA	12151670	12
Smith County Sheriff's Office	Tyler	Smith	TX	12949450	1
Smith Township Police Department	Slovan	Washington	PA	12386920	5
Smithfield Police Department	Smithfield	Johnston	NC	12893600	1
Smithfield Police Department	Smithfield	Isle of Wight	VA	12917590	1

Smithville Police Department	Smithville	Lee	GA	13511950	1
Smyrna Police Department	Smyrna	Kent	DE	11570790	1
Smyrna Police Department	Smyrna	Rutherford	TN	12136440	1
Snohomish County Sheriff's Office	Everett	Snohomish	WA	11356130	2
Socorro County Sheriff's Office	Socorro	Socorro	NM	12819480	3
Socorro I.S.D. Police Dept.	El Paso	El Paso	TX	13299220	1
Solano County Sheriff's Office	Fairfield	Solano	CA	13691860	1
Solon Police Department	Solon	Cuyahoga	OH	12354120	1
Somerset Police Department	Somerset	Perry	OH	12204190	1
Somerton Police Department	Somerton	Yuma	AZ	11387900	1
Somerville Police Department	Somerville	Burleson	TX	12197810	2
Somerville Police Department	Somerville	Middlesex	MA	12691360	2
South Bend Police	South Bend	St. Joseph	IN	12080380	9
South Carolina Department of Mental Health-Public Safety	Columbia	Richland	SC	99900172	1
South Carolina Department of Natural Resources	Columbia	Richland	SC	13666460	1
South Carolina Highway Patrol	Blythewood	Richland	SC	13640860	11
South Carolina Law Enforcement Division	Columbia	Richland	SC	13187110	2
South Charleston Police Department	South Charleston	Clark	OH	12134030	1
South Fayette Township Police Department	Morgan	Allegheny	PA	13316730	3
South Londonderry Township Police Department	Campbelltown	Lebanon	PA	12196950	1
South Milwaukee Police Department	South Milwaukee	Milwaukee	WI	11368920	1
South Ogden Police Department	South Ogden	Weber	UT	12737660	1
South Plainfield Police	South Plainfield	Middlesex	NJ	11463000	1
South Shore Police Department	South Shore	Greenup	KY	11291830	1
South Tucson Police Dept.	South Tucson	Pima	AZ	13121010	1
Southampton Town Police Department	Hampton Bays	Suffolk	NY	12154600	4
Southbury Police Department	Southbury	New Haven	CT	13928090	2
Southern University and A & M College Police	Baton Rouge	East Baton Rouge	LA	13179610	1
Southgate Police Department	Southgate	Wayne	MI	12652820	3
Southport Police Department	Southport	Marion	IN	99900103	1
Southside Police Department	Southside	Etowah	AL	13885880	1
Southwest City Police Dept	Southwest City	McDonald	MO	12062280	2
Spartanburg County Sheriff's Office	Spartanburg	Spartanburg	SC	13986890	2
Spencer Police Department	Spencer	Clay	IA	13699960	1
Spokane County Sheriff's Office	Spokane	Spokane	WA	13323030	2
Spokane Police Department	Spokane	Spokane	WA	12637380	6

Spring Grove Police Dept	Spring Grove	McHenry	IL	11000730	1
Spring Lake Police Department	Spring Lake	Cumberland	NC	12073630	5
Spring Valley Village Police Department	Spring Valley	Rockland	NY	12714680	1
Springettsbury Township Police Department	York	York	PA	12846970	1
Springfield Dept of Public Safety	Springfield	Calhoun	MI	12752860	1
Springfield Police Department	Springfield	Orangeburg	SC	11086690	1
Springfield Police Department	Springfield	Clark	OH	12034020	1
Springfield Police Department	Springfield	Hampden	MA	12241330	17
Springfield Police Department	Springfield	Windsor	VT	12977400	1
Springfield Police Department	Springfield	Bay	FL	13150810	1
Springfield Police Dept	Springfield	Sangamon	IL	11610710	1
Springfield Police Dept	Springfield	Greene	MO	12812270	3
Springfield Township Police Department	Springfield	Union	NJ	99900165	1
St. Bernard Parish Sheriff's Office	Chalmette	St. Bernard	LA	13692460	1
St. Charles County Sheriff's Office	O Fallon	St. Charles	MO	13653060	2
St. Charles Parish Sheriff's Office	Hahnville	St. Charles	LA	13368230	1
St. Charles Police Dept	St Charles	St. Charles	MO	12902240	1
St. Cloud Police Department	St. Cloud	Osceola	FL	13465640	4
St. Croix County Sheriff's Office	Hudson	St. Croix	WI	13281920	1
St. Edward's University Police Department	Austin	Travis	TX	99900158	1
St. George Police Department	St. George	Dorchester	SC	11656640	1
St. George Police Dept	St Louis County	St. Louis	MO	12542230	1
St. Helena Parish Sheriff's Office	Greensburg	St. Helena	LA	11229450	1
St. John The Baptist Parish Sheriff's Office	La Place	St. John the Baptist	LA	13069700	3
St. Joseph County Airport Police	South Bend	St. Joseph	IN	13875580	1
St. Joseph County Sheriff's Office	South Bend	St. Joseph	IN	13990390	3
St. Joseph Police Dept	St Joseph	Buchanan	MO	12982220	1
St. Landry Parish Sheriff's Office	Opelousas	St. Landry	LA	11776320	4
St. Louis (city) Police Dept	St Louis	St. Louis City	MO	12882250	12
St. Louis County Police Dept	St Louis	St. Louis	MO	12052210	2
St. Louis County Sheriff's Office	Clayton	St. Louis	MO	99900002	4
St. Lucie County Sheriff's Office	Fort Pierce	St. Lucie	FL	13030900	2
St. Martin Parish Sheriff's Office	Saint Martinville	St. Martin	LA	11139430	1
St. Martinville Police Department	Saint Martinville	St. Martin	LA	11511590	1
St. Mary's County Sheriff's Office	Leonardtown	St. Marys	MD	13948090	1
St. Mary's University Police Department	San Antonio	Bexar	TX	99900004	1

St. Marys Police Department	St. Marys	Auglaize	OH	12664110	2
St. Matthews Police Department	Louisville	Jefferson	KY	11501850	1
St. Paul Police Department	St. Paul	Wise	VA	12247550	1
St. Paul Police Department	St. Paul	Ramsey	MN	13723970	9
St. Petersburg Police Department	St. Petersburg	Pinellas	FL	13135210	7
St. Tammany Parish Sheriff's Office	Covington	St. Tammany	LA	13723070	2
Stafford Police Department	Stafford	Fort Bend	TX	11817740	1
Stallings Police Department	Stallings	Union	NC	13676160	1
Stamford Police Department	Stamford	Fairfield	CT	13625060	6
Stanislaus County Sheriff's Office	Modesto	Stanislaus	CA	13613660	1
Stanly County Sheriff's Office	Albemarle	Stanly	NC	13195810	1
Stark County Sheriff's Office	Dickinson	Stark	ND	13556550	1
Starr County Sheriff's Office	Rio Grande City	Starr	TX	13902290	1
State College Borough Police Department	State College	Centre	PA	12586930	1
State University at Albany Police	Albany	Albany	NY	13257720	1
Statesville Police Department	Statesville	Iredell	NC	12763660	2
Stayton Police Department	Stayton	Marion	OR	12275630	1
Steger Police Dept	Steger	Cook	IL	11070730	1
Stephens County Sheriff's Office	Duncan	Stephens	OK	11109400	4
Stephens County Sheriff's Office	Toccoa	Stephens	GA	11539480	1
Steuben County Sheriff's Office	Bath	Steuben	NY	11069420	1
Steubenville Police Department	Steubenville	Jefferson	OH	12484090	1
Stillwater Police Department	Stillwater	Payne	OK	12385700	1
Stillwater Police Department	Stillwater	Washington	MN	13709170	1
Stockton Police Department	Stockton	San Joaquin	CA	13711570	2
Stoneville Police Department	Stoneville	Rockingham	NC	12933610	1
Stoughton Police Department	Stoughton	Norfolk	MA	12271350	6
Stover Police Department	Stover	Morgan	MO	12322290	1
Stratford Police Department	Stratford	Fairfield	CT	13100110	3
Stratham Police Department	Stratham	Rockingham	NH	12443350	1
Streamwood Police Dept	Streamwood	Cook	IL	11900770	1
Struthers Police Department	Struthers	Mahoning	OH	12894060	1
Stuart Police Department	Stuart	Guthrie	IA	13789270	1
Sturgis Police Department	Sturgis	St. Joseph	MI	11772750	1
Suffolk County Police Department	Yaphank	Suffolk	NY	12534630	8
Suffolk Police Department	Suffolk	Suffolk	VA	12847520	1

Sugar Land Police Department	Sugar Land	Fort Bend	TX	11157770	2
Sugarcreek Borough Police Department	Franklin	Venango	PA	12116850	1
Sugarcreek Police Department	Sugarcreek	Tuscarawas	OH	12124020	1
Suisun City Police Department	Suisun City	Solano	CA	13097900	1
Sullivan City Police Department	Sullivan City	Hidalgo	TX	11997700	1
Sullivan County Sheriff's Office	Monticello	Sullivan	NY	12109400	1
Sullivan County Sheriff's Office	Blountville	Sullivan	TN	13418240	1
Summerhill Township Police Department	Beaverdale	Cambria	PA	12196800	1
Summit County Sheriff's Office	Akron	Summit	OH	13347930	2
Sumter Police Department	Sumter	Sumter	SC	11946640	3
Sunland Park Police Department	Sunland Park	Dona Ana	NM	12894910	1
Sunrise Police Department	Sunrise	Broward	FL	13827680	1
Sunset Hills Police Department	Sunset Hills	St. Louis	MO	12332240	5
Superior Police Department	Superior	Douglas	WI	12458940	3
Surfside Beach Police Department	Surfside Beach	Brazoria	TX	11397730	1
Surfside Beach Public Safety Department	Surfside Beach	Horry	SC	11426630	1
Surfside Police Department	Surfside	Miami-Dade	FL	13190710	1
Surprise Police Department	Surprise	Maricopa	AZ	13309730	1
Sutter County Sheriff's Office	Yuba City	Sutter	CA	12199430	1
Swampscott Police Department	Swampscott	Essex	MA	12891370	1
Swansea Police Department	Swansea	Lexington	SC	11246610	1
Sweetwater Police Department	Sweetwater	Monroe	TN	11166310	1
Sylvania Police Department	Sylvania	Lucas	OH	12824050	1
Syracuse Police Department	Syracuse	Onondaga	NY	11144590	3
Syracuse Police Department	Syracuse	Davis	UT	13722170	1
Tabor City Police Department	Tabor City	Columbus	NC	13942090	4
Tacoma Police Department	Tacoma	Pierce	WA	12597370	5
Tahlequah Police Department	Tahlequah	Cherokee	OK	12255730	3
Talbot County Sheriff's Office	Talbotton	Talbot	GA	11389330	3
Tallahassee Police Department	Tallahassee	Leon	FL	13151310	1
Tampa Police Department	Tampa	Hillsborough	FL	13287620	4
Tarpon Springs Police Department	Tarpon Springs	Pinellas	FL	11790820	2
Tarrytown Village Police Department	Tarrytown	Westchester	NY	11184590	1
Taylorsville Police Department	Taylorsville	Salt Lake	UT	11307670	1
Tea Police Department	Tea	Lincoln	SD	12776570	1
Tempe Police Department	Tempe	Maricopa	AZ	13350630	1

Temple Police Department	Temple	Carroll	GA	13342830	2
Temple Terrace Police Department	Temple Terrace	Hillsborough	FL	13754670	2
Tennessee Department of Safety	Nashville	Davidson	TN	13306930	7
Tennessee State Constable--Carter County	Elizabethton	Carter	TN	99900110	1
Tennessee State University	Nashville	Davidson	TN	13035400	2
Terrebonne Parish Sheriff's Office	Houma	Terrebonne	LA	13402040	2
Terrell County Sheriff's Office	Sanderson	Terrell	TX	11599350	1
Texarkana Police Department	Texarkana	Bowie	TX	13863880	1
Texas Alcoholic Beverage Commission	Austin	Travis	TX	13951090	1
Texas City Police Department	Texas City	Galveston	TX	11395620	2
Texas Department of Public Safety	Austin	Travis	TX	11198080	9
Thebes Police Department	Thebes	Alexander	IL	99900164	1
Thibodaux Police Department	Thibodaux	Lafourche	LA	11391560	2
Thief River Falls Police Department	Thief River Falls	Pennington	MN	12882550	2
Thomas County Sheriff's Office	Thomasville	Thomas	GA	11069330	2
Thomasville Police Department	Thomasville	Davidson	NC	12533620	1
Tilton Police Dept	Tilton	Vermilion	IL	12890790	1
Tiltonsville Police Department	Tiltonsville	Jefferson	OH	13043300	1
Tinley Park Police Dept	Tinley Park	Cook	IL	12320700	2
Tipton Police Department	Tipton	Tillman	OK	12895770	1
Titusville Police Department	Titusville	Brevard	FL	13749370	1
Tohono O'Odham Tribal Police	Sells	Pima	AZ	13575850	2
Toledo Police Department	Toledo	Lucas	OH	13184510	15
Tolleson Police Department	Tolleson	Maricopa	AZ	13597550	1
Topeka Police Department	Topeka	Shawnee	KS	12740040	5
Torrington Police Department	Torrington	Litchfield	CT	13784270	1
Towns County Sheriff's Office	Young Harris	Towns	GA	13318930	1
Travelers Rest Police Department	Travelers Rest	Greenville	SC	11436610	1
Traverse City Police Department	Traverse City	Grand Traverse	MI	11332790	1
Trenton Police	Trenton	Mercer	NJ	12143090	7
Trotwood Police Department	Trotwood	Montgomery	OH	12984020	1
Troy Police Department	Troy	Rensselaer	NY	11524560	1
Truro Police Department	Truro	Barnstable	MA	12141320	1
Tucson Police Department	Tucson	Pima	AZ	13353730	9
Tucumcari Police Department	Tucumcari	Quay	NM	12024930	1
Tukwila Police Department	Tukwila	King	WA	12237330	1

Tulare County Sheriff's Office	Visalia	Tulare	CA	13775670	3
Tulare Police Department	Tulare	Tulare	CA	13202820	1
Tulsa Police Department	Tulsa	Tulsa	OK	12995740	11
Tupelo Police Department	Tupelo	Lee	MS	13588850	1
Turkey Creek Police Department	Turkey Creek	Evangeline	LA	11771500	1
Turlock Police Department	Turlock	Stanislaus	CA	13679860	1
Turner Police Department	Turner	Marion	OR	12575610	1
Turrell Police Department	Turrell	Crittenden	AR	13970990	2
Tuscaloosa Police Department	Tuscaloosa	Tuscaloosa	AL	13576450	1
Tuscola County Sheriff's Office	Caro	Tuscola	MI	12529350	1
Tuscumbia Police Department	Tuscumbia	Colbert	AL	13597150	2
Tuskegee Police Department	Tuskegee	Macon	AL	13554750	2
Tuskegee University Police Department	Tuskegee	Macon	AL	99900027	1
Tutwiler Police Department	Tutwiler	Tallahatchie	MS	13272520	1
Tuxedo Park Village Police Department	Tuxedo Park	Orange	NY	11084560	1
Twin Falls Police Department	Twin Falls	Twin Falls	ID	13655360	1
Tyrone Police Department	Tyrone	Fayette	GA	13426340	2
Ulster County Sheriff's Office	Kingston	Ulster	NY	12219350	1
Unified Police Department	Salt Lake	Salt Lake	UT	99900007	1
Union City Police	Union City	Hudson	NJ	12603050	3
Union City Police Department	Union City	Obion	TN	11656360	1
Union County Sheriff's Office	Liberty	Union	IN	12309320	1
Union County Sheriff's Office	Monroe	Union	NC	13964790	1
Union Police Department	Union	Newton	MS	11928480	1
Union Public Safety Department	Union	Union	SC	12076650	1
Uniontown Police Department	Uniontown	Fayette	PA	12246820	1
United I.S.D. Police Dept.	Laredo	Webb	TX	13953790	1
University of Alabama - Birmingham Police Dept	Birmingham	Jefferson	AL	13506650	1
University of Arkansas Medical Sciences Dept of Pub	Little Rock	Pulaski	AR	11954480	1
University of California - Los Angeles Police	Los Angeles	Los Angeles	CA	13449340	1
University of Colorado - Colorado Springs Police Dept.	Colorado Springs	El Paso	CO	13029200	1
University of Florida Police	Gainesville	Alachua	FL	11990107	1
University of Illinois Police Dept	Urbana	Champaign	IL	13997090	1
University of Maryland Eastern Shore Dept of Public Safety	Princess Anne	Somerset	MD	13351730	1
University of North Texas Police Department	Denton	Denton	TX	13201320	1
University of Pittsburgh - Main Campus Police	Pittsburgh	Allegheny	PA	13295020	1

University of Pittsburgh at Johnstown Police	Johnstown	Cambria	PA	13089800	1
University of South Carolina - Upstate Police Department	Spartanburg	Spartanburg	SC	13554650	1
University of Tennessee at Knoxville Police	Knoxville	Knox	TN	13000900	2
University of Texas - Austin Police	Austin	Travis	TX	11990045	1
University of West Alabama Police	Livingston	Sumter	AL	11572650	1
Uplands Park Police Department	Uplands Park	St. Louis	MO	11212150	5
Upper Sandusky Police Department	Upper Sandusky	Wyandot	OH	12294060	1
Upshur County Sheriff's Office	Gilmer	Upshur	TX	13869780	1
Utah Department of Public Safety	Salt Lake City	Salt Lake	UT	13510150	2
Utica Police Department	Utica	Oneida	NY	11464590	2
Vacaville Police Department	Vacaville	Solano	CA	13030800	1
Vail Police Department	Vail	Eagle	CO	13129510	1
Valdosta Police Department	Valdosta	Lowndes	GA	13982290	1
Valencia County Sheriff's Office	Los Lunas	Valencia	NM	13543650	2
Valley Brook Police Department	Valley Brook	Oklahoma	OK	12185720	1
Valparaiso Police	Valparaiso	Porter	IN	12220390	1
Van Buren Township Police Department	Belleville	Wayne	MI	11832750	1
Vanderbilt University Police Department	Nashville	Davidson	TN	99900159	1
Vandergrift Borough Police Department	Vandergrift	Westmoreland	PA	13902790	2
Velda City Police Department	Velda City	St. Louis	MO	11782150	1
Venice Police Dept	Venice	Madison	IL	12660720	1
Ventura College	Ventura	Ventura	CA	13090700	1
Ventura County Sheriff's Office	Ventura	Ventura	CA	13904790	1
Vergennes Police Department	Vergennes	Addison	VT	12027460	2
Vermont State Police	Waterbury	Washington	VT	13167510	1
Vernal Police Department	Vernal	Uintah	UT	12957600	1
Vernon Parish Sheriff's Office	Leesville	Vernon	LA	12419390	2
Vian Police Department	Vian	Sequoyah	OK	12505760	1
Victoria Police Department	Victoria	Victoria	TX	12997730	2
Vidalia Police Department	Vidalia	Concordia	LA	11861500	1
Vidor Police Department	Vidor	Orange	TX	12057790	1
Vigo County Sheriff's Office	Terre Haute	Vigo	IN	12149380	1
Vineland Police	Vineland	Cumberland	NJ	12313010	2
Vinita Police Department	Vinita	Craig	OK	12355730	1
Virginia Beach Police Department	Virginia Beach	Virginia Beach City	VA	12417590	10
Virginia Commonwealth University Police Dept.	Richmond	Richmond City	VA	11956410	2

Virginia Marine Resources Commission	Newport News	Newport News City	VA	13976990	1
Virginia Police Department	Virginia	St. Louis	MN	12512590	1
Virginia State Police	Richmond	Chesterfield	VA	13186710	3
Visalia Department of Public Safety	Visalia	Tulare	CA	13058300	1
Vivian Police Department	Vivian	Caddo	LA	11111570	2
Volusia County Beach Patrol	Daytona Beach	Volusia	FL	11961470	3
Volusia County Sheriff's Office	Deland	Volusia	FL	11811330	4
Waco Police Department	Waco	McLennan	TX	12777760	8
Wagoner Police Department	Wagoner	Wagoner	OK	12005760	2
Waite Hill Police Department	Waite Hill	Lake	OH	11234090	1
Wake County Sheriff's Office	Raleigh	Wake	NC	13154110	4
Wakeman Police Department	Wakeman	Huron	OH	11474050	1
Walker County Sheriff's Office	La Fayette	Walker	GA	12589340	2
Walkerton Police	Walkerton	St. Joseph	IN	12210350	1
Wall Township Police	Wall Township	Monmouth	NJ	12403070	1
Walla Walla Police Department	Walla Walla	Walla Walla	WA	12107320	1
Wallace Police Department	Wallace	Duplin	NC	12153650	2
Waller Police Department	Waller	Waller	TX	12227750	1
Wallingford Police Department	Wallingford	New Haven	CT	11188590	1
Walnut Cove Police Department	Walnut Cove	Stokes	NC	12913650	1
Walnut Creek Police Department	Walnut Creek	Contra Costa	CA	13447140	3
Walton County Sheriff's Office	Defuniak Springs	Walton	FL	13503350	4
Warren County Sheriff's Office	Warrenton	Warren	NC	13200420	1
Warren Police Department	Warren	Macomb	MI	11752700	1
Warren Police Department	Warren	Worcester	MA	12771350	1
Warren Police Department	Warren	Trumbull	OH	13332530	3
Warrensburg Police Dept	Warrensburg	Macon	IL	12650780	2
Warsaw Police Department	Warsaw	Gallatin	KY	11701890	1
Washington County Sheriff's Office	Hagerstown	Washington	MD	12819290	1
Washington County Sheriff's Office	Johnson City	Washington	TN	13831380	1
Washington Court House Police Dept.	Washington Court House	Fayette	OH	13453240	1
Washington Metropolitan Area Transit Authority Police	Washington	District of Columbia	DC	13375830	3
Washington Metropolitan Police Department	Washington	District of Columbia	DC	13766670	32
Washington Park Police Dept	Washington Park	St. Clair	IL	12940720	3
Washington Police Department	Washington	Beaufort	NC	12413660	1
Washington State Patrol	Olympia	Thurston	WA	13008900	2

Washington Township Police	Sewell	Gloucester	NJ	12233060	1
Washington Township Police Department	Bangor	Northampton	PA	11276820	1
Washington Township Police Department	Belle Vernon	Fayette	PA	11756820	1
Washoe County Sheriff's Office	Reno	Washoe	NV	13378930	4
Washtenaw County Sheriff's Office	Ann Arbor	Washtenaw	MI	13571750	4
Waterbury Police Department	Waterbury	New Haven	CT	13775970	5
Waterford Township Police	Atco	Camden	NJ	11124990	2
Waterloo Police Department	Waterloo	Black Hawk	IA	13707570	5
Waukegan Police Dept	Waukegan	Lake	IL	12000700	3
Waukesha County Sheriff's Office	Waukesha	Waukesha	WI	13793370	2
Waukomis Police Department	Waukomis	Garfield	OK	12205710	1
Wausau Police Department	Wausau	Marathon	WI	13721670	1
Waxhaw Police Department	Waxhaw	Union	NC	12563650	1
Wayne County Sheriff's Office	Goldsboro	Wayne	NC	13412140	2
Wayne County Sheriff's Office	Detroit	Wayne	MI	13497440	1
Wayne Police Department	Wayne	McClain	OK	12275780	1
Wayne State University Dept of Public Safety	Detroit	Wayne	MI	13755870	1
Wayne Township Police	Wayne	Passaic	NJ	11954940	1
Waynesboro Borough Police Department	Waynesboro	Franklin	PA	11386830	1
Waynesboro Police Department	Waynesboro	Burke	GA	13677860	2
Waynesburg Borough Police Department	Waynesburg	Greene	PA	11526880	1
Waynesville Police Department	Waynesville	Haywood	NC	12643670	1
Webb County Constable Pct. 1	Laredo	Webb	TX	11331230	1
Weirton Police Department	Weirton	Hancock	WV	11118770	1
Weld County Sheriff's Office	Greeley	Weld	CO	12189230	1
Wellston Police Department	Saint Louis	St. Louis	MO	13423240	2
Wesson Police Department	Wesson	Copiah	MS	12163960	1
West Bloomfield Township Police Department	West Bloomfield	Oakland	MI	13283120	1
West Chester Borough Police Department	West Chester	Chester	PA	11696860	1
West Chester Police Department	West Chester	Butler	OH	11014000	1
West Columbia Police Department	West Columbia	Brazoria	TX	11867330	1
West Concord Police Department	West Concord	Dodge	MN	12322500	1
West Des Moines Police Department	West Des Moines	Polk	IA	13312330	1
West Fargo Police Department	West Fargo	Cass	ND	11163540	1
West Haven Police Department	West Haven	New Haven	CT	13033500	2
West Jordan Police Department	West Jordan	Salt Lake	UT	13990890	2

West Manchester Township Police Department	York	York	PA	12816820	1
West Melbourne Police Department	West Melbourne	Brevard	FL	13923690	1
West Memphis Police Department	West Memphis	Crittenden	AR	13972490	3
West Mifflin Borough Police Department	West Mifflin	Allegheny	PA	12526880	3
West Milton Police Department	West Milton	Miami	OH	11154020	2
West New York Police	West New York	Hudson	NJ	11784960	1
West Palm Beach Police Department	West Palm Beach	Palm Beach	FL	13509150	3
West Paterson Borough	West Paterson	Passaic	NJ	11024990	1
West Pittston Borough Police Department	Exeter	Luzerne	PA	12706810	1
West Point Police Department	West Point	Hardin	KY	11451830	1
West Reading Borough Police Department	Reading	Berks	PA	12126820	3
West Richland Police Department	West Richland	Benton	WA	12037380	2
West Seneca Town Police Department	West Seneca	Erie	NY	13024200	2
West Valley City Police Department	West Valley City	Salt Lake	UT	13503650	1
West View Borough Police Department	Pittsburgh	Allegheny	PA	12566880	1
West Warwick Police Department	West Warwick	Kent	RI	12066710	1
West Yellowstone Police Department	West Yellowstone	Gallatin	MT	12663900	1
West York Borough Police Department	York	York	PA	12916890	2
Westchester County Department of Public Safety	Hawthorne	Westchester	NY	12464500	3
Westchester Police Dept	Westchester	Cook	IL	12140710	1
Westerly Police Department	Westerly	Washington	RI	12376790	1
Westfield Police	Westfield	Hamilton	IN	12910330	4
Westlake Hills Police Department	Austin	Travis	TX	12177790	1
Westminster Police Department	Westminster	Orange	CA	13775170	3
Westminster Police Dept	Westminster	Adams	CO	13399330	4
Westmoreland County Sheriff's Office	Greensburg	Westmoreland	PA	12919210	1
Weston Police Department	Weston	Platte	MO	13581550	2
Wetumpka Police Department	Wetumpka	Elmore	AL	13091300	1
Weymouth Police Department	Weymouth	Norfolk	MA	12231380	1
Wheatland Police Department	Wheatland	Yuba	CA	13365630	1
Wheaton Police Dept	Wheaton	Du Page	IL	12290700	1
Wheeler Police Department	Wheeler	Dunn	WI	99900104	2
Wheeling Police Department	Wheeling	Ohio	WV	11138760	3
White Cloud Police Department	White Cloud	Newaygo	MI	13515450	1
White County Sheriff's Office	Sparta	White	TN	12349200	1
White County Sheriff's Office	Cleveland	White	GA	13037600	1

White House Police Department	White House	Sumner	TN	12236320	1
White Plains Police Department	White Plains	Westchester	NY	12674580	1
White Township Police Department	Beaver Falls	Beaver	PA	12746840	1
Whitehall Police Department	Whitehall	Franklin	OH	12114010	1
Whitemarsh Township Police Department	Lafayette Hill	Montgomery	PA	12406880	1
Whiteville Police Department	Whiteville	Hardeman	TN	12816390	1
Whitfield County Sheriff's Office	Dalton	Whitfield	GA	13740270	1
Whitley County Sheriff's Office	Williamsburg	Whitley	KY	13748770	1
Whitpain Township Police Department	Blue Bell	Montgomery	PA	12836840	1
Wichita Falls Police Department	Wichita Falls	Wichita	TX	12917740	4
Wichita Police Department	Wichita	Sedgwick	KS	11980090	2
Wicomico County Sheriff's Office	Salisbury	Wicomico	MD	13013200	1
Wildwood Police	Wildwood	Cape May	NJ	11784990	2
Wilkes Barre City Police Department	Wilkes Barre	Luzerne	PA	12286800	1
Wilkesboro Police Department	Wilkesboro	Wilkes	NC	11673600	1
Wilkinsburg Borough Police Department	Pittsburgh	Allegheny	PA	12006890	3
Will County Sheriff's Office	Joliet	Will	IL	11552330	1
Williams Police Department	Williams	Colusa	CA	13599050	1
Williamsburg Police Department	Williamsburg	Whitley	KY	12171810	2
Williamson County Sheriff's Office	Marion	Williamson	IL	11439200	2
Williamson County Sheriff's Office	Franklin	Williamson	TN	11569200	2
Williamson County Sheriff's Office	Georgetown	Williamson	TX	13387030	2
Willimantic Police Department	Willimantic	Windham	CT	13654060	1
Wilmette Police Dept	Wilmette	Cook	IL	12360770	1
Wilmington Police Department	Wilmington	New Castle	DE	11324450	2
Wilmington Police Department	Wilmington	New Hanover	NC	13250420	2
Wilson County Sheriff's Office	Lebanon	Wilson	TN	13711670	1
Wilson Police Department	Wilson	Ellsworth	KS	11730030	1
Wilson Police Department	Wilson	Wilson	NC	12553670	2
Wilton Police Department	Wilton	Fairfield	CT	13587450	2
Windber Borough Police Department	Windber	Somerset	PA	11316760	1
Windermere Police Department	Windermere	Orange	FL	13476040	4
Windsor Locks Police Department	Windsor Locks	Hartford	CT	11005730	2
Winfield Police Department	Winfield	Lincoln	MO	11222100	1
Winkler County Sheriff's Office	Kermit	Winkler	TX	13810280	2
Winn Parish Sheriff's Office	Winnfield	Winn	LA	11549240	1

Winnebago County Sheriff's Office	Rockford	Winnebago	IL	13877180	2
Winnemucca Police Department	Winnemucca	Humboldt	NV	12514880	1
Winnfield Police Dept	Winnfield	Winn	LA	12061580	1
Winnsboro Police Department	Winnsboro	Franklin	LA	12601520	1
Winooski Police Department	Winooski	Chittenden	VT	12917440	1
Winsted Police Department	Winsted	Litchfield	CT	99900016	3
Winston-Salem Police Department	Winston-Salem	Forsyth	NC	11962750	3
Winter Haven Police Department	Winter Haven	Polk	FL	13206020	1
Winters Police Department	Winters	Yolo	CA	13447540	2
Winterville Police Department	Winterville	Pitt	NC	11883620	1
Wisconsin Dells Police Department	Wisconsin Dells	Columbia	WI	12058980	1
Wisconsin Dept of Justice - Criminal Investigation Division	Madison	Dane	WI	13504950	1
Woburn Police Department	Woburn	Middlesex	MA	12571250	1
Wolcott Police Department	Wolcott	New Haven	CT	13276520	1
Wolfeboro Police Department	Wolfeboro	Carroll	NH	12813370	1
Womelsdorf Police Department	Womelsdorf	Berks	PA	11946700	1
Wood County Sheriff's Office	Parkersburg	Wood	WV	11159200	2
Woodbridge Police	Woodbridge	Middlesex	NJ	11844900	2
Woodburn Police Department	Woodburn	Marion	OR	11005580	2
Woodford County Sheriff's Office	Eureka	Woodford	IL	12059260	1
Woodland Police Department	Woodland	Yolo	CA	13599450	1
Woodridge Police Dept	Woodridge	Du Page	IL	12130640	1
Woodruff County Sheriff's Office	Augusta	Woodruff	AR	13059400	1
Woodstock Police Department	Woodstock	Grafton	NH	12223320	1
Woodstock Police Department	Woodstock	Cherokee	GA	13278820	1
Woodstock Police Dept	Woodstock	McHenry	IL	12100670	1
Woonsocket Police Department	Woonsocket	Providence	RI	12326710	4
Worcester Police Department	Worcester	Worcester	MA	12141260	5
Worthington Police Department	Worthington	Greenup	KY	12661820	1
Wyandotte Police Department	Wyandotte	Wayne	MI	12852770	1
Wynona Police Department	Wynona	Osage	OK	12585650	1
Wyoming Borough Police Department	Wyoming	Luzerne	PA	11126760	1
Wyoming Highway Patrol	Cheyenne	Laramie	WY	11224330	1
Wyoming Police Department	Wyoming	Kent	DE	13116110	2
Yakama Nation Tribal Police	Toppenish	Yakima	WA	12937390	2
Yakima County Sheriff's Office	Yakima	Yakima	WA	12689230	2

Yakima Police Department	Yakima	Yakima	WA	12467370	1
Yamhill County Sheriff's Office	McMinnville	Yamhill	OR	12859210	1
Yellowstone County Sheriff's Office	Billings	Yellowstone	MT	12399280	1
Yemassee Police Department	Yemassee	Hampton	SC	12766620	1
Yonkers Police Department	Yonkers	Westchester	NY	12984510	2
York Police Department	York	York	PA	11686760	1
Yorkville Police Department	Yorkville	Jefferson	OH	12534080	1
Yorkville Police Dept	Yorkville	Kendall	IL	12670640	1
Youngsville Police Department	Youngsville	Lafayette	LA	12081510	2
Yuma Police Department	Yuma	Yuma	AZ	13165910	2
Zanesville Police Department	Zanesville	Muskingum	OH	12464040	4
Zapata County Sheriff's Office	Zapata	Zapata	TX	12799240	1
Zolfo Springs Police Department	Zolfo Springs	Hardee	FL	13452440	1

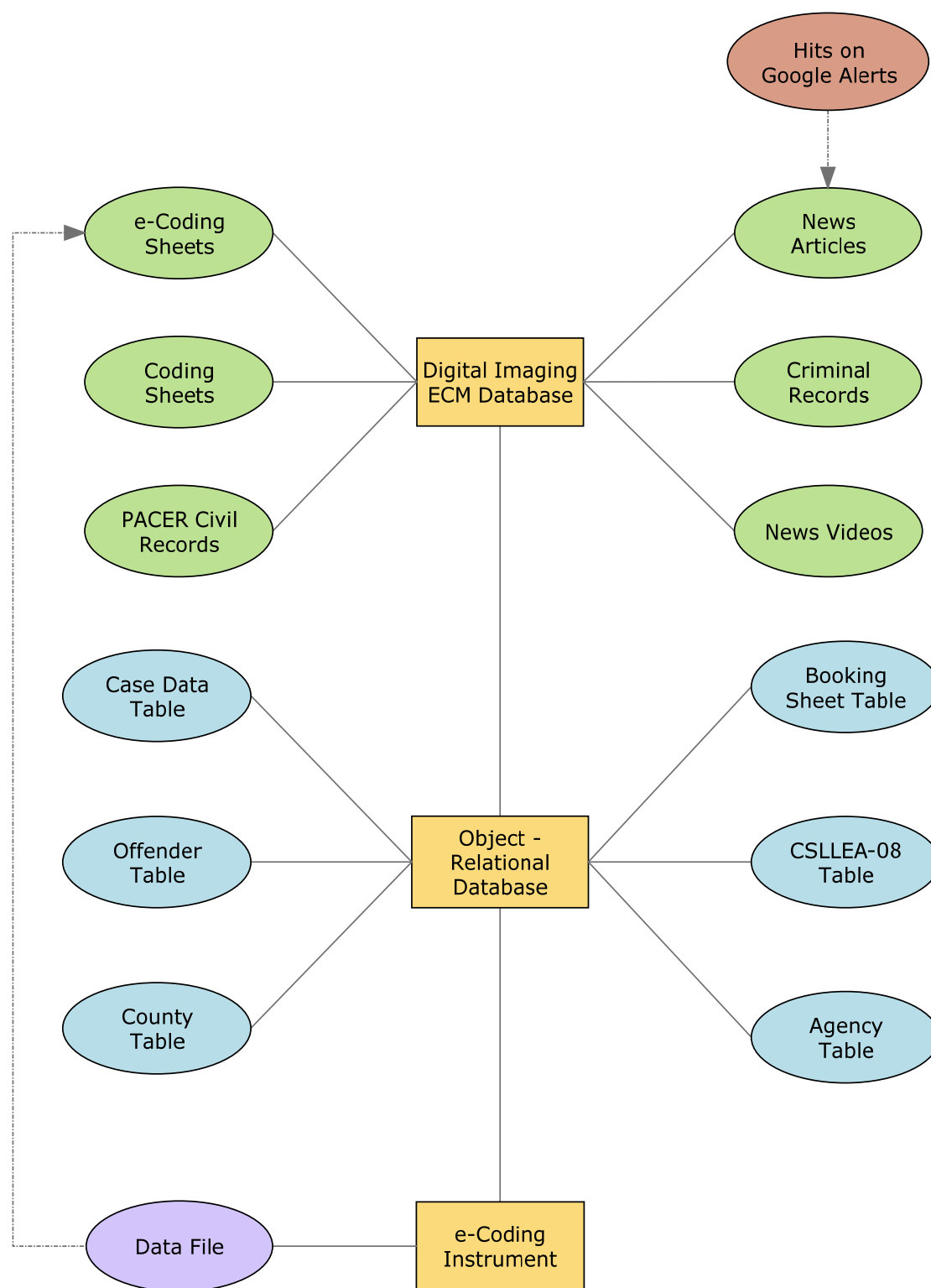

Appendix E. Entity Relationship Diagram of Stinson's Police Crime Database